



Kanlux

Catalogue
Catalogo
20**24**

**more than
light.**

more than
more than **light.**
light.

Kanlux





14
33

LUMINAIRES USINE KANLUX
PRODOTTI KANLUX FACTORY

34
101

SOURCES LUMINEUSES
LAMPADINE

102
205

LUMINAIRES DOMESTIQUES ET DECORATIFS
PRODOTTI DECORATIVI E DOMESTICI

206
313

LUMINAIRES TECHNIQUES ET FONCTIONNELS
PRODOTTI TECNICI E ARCHITETTONICI

314
351

EQUIPEMENTS ELECTRIQUES
MATERIALE ELETTRICO E ACCESSORI

LUMINAIRES
USINE
KANLUX
PRODOTTI
KANLUX
FACTORY

Kanlux
FACTORY



Kanlux ALIN LED
◀ 16 - 17 ▶

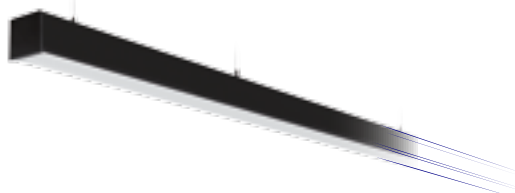

Kanlux ALIN LED LINE
◀ 18 - 19 ▶

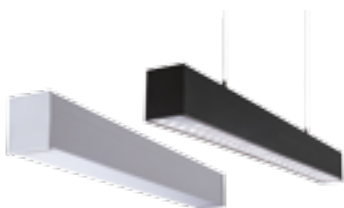

Kanlux ALIN 4LED
◀ 20 - 21 ▶

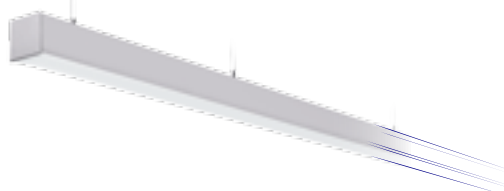

Kanlux ALIN 4LED LINE
◀ 22 - 23 ▶



Kanlux OFIS S LED
◀ 24 - 25 ▶



Kanlux HIERRO LED
◀ 26 - 27 ▶



Kanlux FUTURIO LED
◀ 28 - 29 ▶



Kanlux ADTR
◀ 30 - 31 ▶



SOURCES LUMINEUSES LAMPADINE



Kanlux Kanlux SMART
◀ 36 ▶



Kanlux Kanlux SMART
◀ 37 ▶



Kanlux IQ-LED LIFE
◀ 38 ▶



Kanlux IQ-LED LIFE
◀ 39 ▶



Kanlux IQ-LED A60
◀ 40 ▶



Kanlux IQ-LED A67
◀ 41 ▶



Kanlux IQ-LEDDIM A60
◀ 42 ▶



Kanlux XLED EX A60
◀ 43 ▶



Kanlux XLED A60
◀ 44 ▶



Kanlux XLED A70
◀ 45 ▶



Kanlux XLED A60M
◀ 46 ▶



Kanlux XLED STEPDIM
◀ 47 ▶



Kanlux XLEDIM A60
◀ 47 ▶



Kanlux XLED A60 B22 M
◀ 48 ▶



Kanlux XLEDIM A60 B22
◀ 48 ▶



Kanlux RAPIDv2 LED
◀ 49 ▶



Kanlux ST45 LED
◀ 50 ▶



Kanlux ST64 A
◀ 51 ▶



Kanlux XLED ST64
◀ 51 ▶



Kanlux XLED A60 MIRROR
◀ 52 ▶



Kanlux XLED G95
◀ 52 ▶



Kanlux XLED G125
◀ 53 ▶



Kanlux XLED G125
◀ 53 ▶



XLED SW
◀ 54 ▶



XLED W
◀ 55 ▶



Kanlux IQ-LED C35
◀ 56 ▶



Kanlux XLEDEX C35
◀ 57 ▶



Kanlux XLEDDIM C35
◀ 57 ▶



Kanlux XLED C35
◀ 58 ▶



Kanlux XLED C35M
◀ 58 ▶



Kanlux DUN LED
◀ 59 ▶



Kanlux IDO LED 6,5W
◀ 59 ▶



Kanlux IQ-LED G45
◀ 60 ▶



Kanlux XLEDEX G45
◀ 61 ▶



Kanlux XLED G45
◀ 62 ▶



Kanlux XLED G45M
◀ 63 ▶



Kanlux BILO LED
◀ 64 ▶



Kanlux IQ-LEDEX GU10
◀ 65 ▶



Kanlux IQ-LED GU10 4,9W
◀ 65 ▶



Kanlux IQ-LED GU10
◀ 66 ▶



Kanlux IQ-LEDIM GU10
◀ 67 ▶



Kanlux K LED GU10 6W
◀ 67 ▶

SOURCES LUMINEUSES LAMPADINE



Kanlux TOMiv2 LED
◀ 68 ▶



Kanlux REMI LED
◀ 69 ▶



Kanlux TEDI MAXX LED
◀ 69 ▶



Kanlux ZUBI LED
◀ 70 ▶



Kanlux TANO G4
◀ 71 ▶



Kanlux LEDI2 G4
◀ 71 ▶



Kanlux IQ-LED AR-111
◀ 72 ▶



Kanlux IQ-LED ES-111
◀ 72 ▶



Kanlux IQ-LED EX T8
◀ 73 ▶



Kanlux T8 LED GLASSv3
◀ 74 ▶



Kanlux T8 LED GLASSv3T
◀ 74 ▶



Kanlux T8 LED GLASSv4
◀ 75 ▶



Kanlux T8 LED GLASSv5
◀ 75 ▶



Kanlux TOMI LED
◀ 76 ▶



Kanlux SIGO LED
◀ 76 ▶



Kanlux ESG LED
◀ 77 ▶



Kanlux RANGO LED
◀ 77 ▶



Kanlux MODv2 LED
◀ 78 ▶



Kanlux LEDS-B
◀ 79 ▶



Kanlux LED STRIP L60
◀ 80 ▶

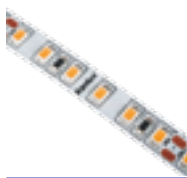

Kanlux LED STRIP L120
◀ 81 ▶

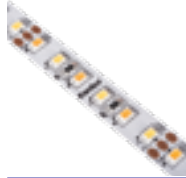

Kanlux LED STRIP L120 CCT
◀ 82 ▶



Kanlux LED STRIP LCOB 12V
◀ 83 ▶



Kanlux LED STRIP LCOB 24V
◀ 84 ▶



Kanlux LEDS-B RGB
◀ 85 ▶



Kanlux LED STRIP L48 RGBW
◀ 86 ▶



Kanlux COB SET
◀ 86 ▶



Kanlux CONTROLLER
MONO/CCT
◀ 87 ▶



Kanlux CONTROLLER
RGBW CCT
◀ 87 ▶



Kanlux PROFILO B
◀ 88 ▶



Kanlux PROFILO C
◀ 89 ▶



Kanlux PROFILO D
◀ 90 ▶



Kanlux PROFILO F
◀ 91 ▶



Kanlux PROFILO G
◀ 92 ▶



Kanlux PROFILO H
◀ 93 ▶



Kanlux PROFILO J
◀ 94 ▶



Kanlux PROFILO K
◀ 95 ▶



Kanlux NEON LEDI2W/M
◀ 96 ▶



Kanlux XLED HP D9
◀ 98 ▶



Kanlux XLED HP D46
◀ 98 ▶



Kanlux G9 STAR
◀ 99 ▶



Kanlux J
◀ 99 ▶



Kanlux J STAR
◀ 100 ▶



Kanlux T5
◀ 100 ▶



Kanlux T8
◀ 101 ▶



Kanlux MHE
◀ 101 ▶

**LUMINAIRES
DOMESTIQUES
ET DECORATIFS**
PROTTOTTI
DECORATIVI
E DOMESTICI



Kanlux AGZAR C
◀ 104 ▶



Kanlux GALOBA C
◀ 104 ▶



Kanlux JASMIN C
◀ 105 ▶



Kanlux ETISSA
◀ 106 ▶



Kanlux OGIVA
◀ 106 ▶



Kanlux SANI IP44
◀ 107 ▶



Kanlux SONOR GU10
◀ 107 ▶



Kanlux AQILO IP65
◀ 108-109 ▶



Kanlux STOBI
◀ 110 ▶



Kanlux RITI
◀ 111 ▶



Kanlux BORD
◀ 111 ▶



Kanlux BORD XS
◀ 112 ▶



Kanlux GORD XS
◀ 112 ▶



Kanlux BLURRO
◀ 113 ▶



Kanlux CARVO LED
◀ 114 ▶



Kanlux LUMKO LED
◀ 114 ▶



Kanlux BONSA LED
◀ 115 ▶



Kanlux EXATE LED
◀ 115 ▶



Kanlux SOLN LED
◀ 116 ▶



Kanlux AMAZI LED
◀ 116 ▶



Kanlux VAND LED
◀ 117 ▶



Kanlux RIFA LED
◀ 118-119 ▶



Kanlux ARVOS LED
◀ 120 ▶



Kanlux JASMIN W
◀ 121 ▶



Kanlux JASMIN
◀ 122-123 ▶



Kanlux DERATO
◀ 124-125 ▶



Kanlux EVALO
◀ 126-127 ▶



Kanlux SONDA II
◀ 128-129 ▶



Kanlux GALOBA
◀ 130-131 ▶



Kanlux LAURIN
◀ 132-133 ▶



Kanlux SEMPRA
◀ 134-135 ▶



Kanlux ENALI
◀ 136-137 ▶



Kanlux MILENO
◀ 138-139 ▶



Kanlux BOLA LED
◀ 140 ▶



Kanlux ULOV LED
◀ 140 ▶



Kanlux ORISA LED
◀ 141 ▶



Kanlux HOFI LED
◀ 141 ▶



Kanlux CALIZA LED
◀ 142 ▶



Kanlux GALOBA W
◀ 143 ▶

**LUMINAIRES
DOMESTIQUES
ET DECORATIFS**
PROTTOTTI
DECORATIVI
E DOMESTICI



Kanlux TONIL II LED ◀ 143 ▶	Kanlux AGZAR EL ◀ 144 ▶	Kanlux AGZAR E14 ◀ 144 ▶	Kanlux LARATA EL ◀ 145 ▶	Kanlux LARATA E27 ◀ 145 ▶	Kanlux FLUXY LED IP44 ◀ 146 ▶	Kanlux INITA LED IP54 ◀ 147 ▶
Kanlux EVALO TL ◀ 148 ▶	Kanlux EVALO FL ◀ 149 ▶	Kanlux RAIBO E27 ◀ 150 ▶	Kanlux JUJI E27 ◀ 151 ▶	Kanlux NEDIA E14 ◀ 151 ▶	Kanlux PIXA ◀ 152 ▶	Kanlux HERON II LED ◀ 152 ▶
Kanlux ZARA ◀ 153 ▶	Kanlux SUZI ◀ 153 ▶	Kanlux PRED A LED ◀ 154 ▶	Kanlux REXAR LED ◀ 155 ▶	Kanlux FRANCO II LED ◀ 155 ▶	Kanlux GLOZO DSO ◀ 156 ▶	Kanlux GLOZO DSL ◀ 157 ▶
Kanlux FELINE DSO ◀ 158 ▶	Kanlux FELINE DSL ◀ 159 ▶	Kanlux GOVIK ◀ 160-161 ▶	Kanlux CHIRO GU10 ◀ 162 ▶	Kanlux SPAG ◀ 162 ▶	Kanlux MINI RITI ◀ 163 ▶	Kanlux MINI GORD ◀ 163 ▶
Kanlux MINI BORD ◀ 164 ▶	Kanlux TINY BORD ◀ 164 ▶	Kanlux IMINES ◀ 165 ▶	Kanlux AGEO ◀ 165 ▶	Kanlux APRILA ◀ 165 ▶	Kanlux SEIDY ◀ 166-167 ▶	Kanlux SIMEN DSO ◀ 168 ▶
Kanlux SIMEN DSL ◀ 168 ▶	Kanlux ALOR ◀ 169 ▶	Kanlux ELNIS S ◀ 170 ▶	Kanlux ELNIS L ◀ 170 ▶	Kanlux SOREN ◀ 171 ▶	Kanlux DALLA ◀ 171 ▶	Kanlux ELICEO ◀ 172 ▶

**LUMINAIRES
DOMESTIQUES
ET DECORATIFS**
PROTTOTTI
DECORATIVI
E DOMESTICI



Kanlux MORTA
◀ 173 ▶



Kanlux MORTA DT
◀ 173 ▶



Kanlux MORTA OCT
◀ 174 ▶



Kanlux MORTA B
◀ 174 ▶



Kanlux IVRI
◀ 175 ▶



Kanlux ARET
◀ 175 ▶



Kanlux ALREN R
◀ 176 ▶



Kanlux ALREN
◀ 176 ▶



Kanlux COLIE
◀ 177 ▶



Kanlux NESTA
◀ 177 ▶



Kanlux EVIT
◀ 178 ▶



Kanlux GWEN
◀ 178 ▶



Kanlux LUTO
◀ 179 ▶



Kanlux NAVI
◀ 179 ▶



Kanlux VIDI
◀ 180 ▶



Kanlux RADAN
◀ 181 ▶



Kanlux TESON
◀ 181 ▶



Kanlux HORN
◀ 181 ▶



Kanlux ARGUS II
◀ 182-183 ▶



Kanlux TRIBIS II
◀ 184-185 ▶



Kanlux DROXY IP65
◀ 186 ▶



Kanlux FLINI IP44
◀ 186 ▶



Kanlux QULES
◀ 187 ▶



Kanlux MARIN
◀ 187 ▶



Kanlux OVO
◀ 188 ▶



Kanlux IMBER LED
◀ 188 ▶



Kanlux ASTIM LED IP44
◀ 189 ▶



Kanlux ROLSO
◀ 189 ▶



Kanlux ASTEN LED IP44
◀ 190-191 ▶



Kanlux AKVO IP44 S
◀ 192 ▶



Kanlux AKVO IP44
◀ 193 ▶



Kanlux ERINUS LED
◀ 194-195 ▶



Kanlux APUS LED
◀ 196 ▶



Kanlux TERRA LED
◀ 197 ▶



Kanlux SABIK LED
◀ 198 ▶



Kanlux SOLA LED
◀ 199 ▶



Kanlux IRS 3XAAA
◀ 200 ▶



Kanlux MEFIS LED
◀ 200 ▶



Kanlux ZEPO
◀ 202 ▶



Kanlux MERA LED
◀ 203 ▶



Kanlux HAXA LED
◀ 204 ▶



Kanlux LINUS LED
◀ 204 ▶



Kanlux GAVI CT
◀ 205 ▶



Kanlux GAVI LED
◀ 205 ▶



**LUMINAIRES
TECHNIQUES
ET FONCTIONNELS**
PROTTOTTI
DECORATIVI
E DOMESTICI

						
Kanlux BLINGO LED ◀ 208-209 ▶	Kanlux BLINGO CV ◀ 210-211 ▶	BRAVO LED ◀ 212-213 ▶	Kanlux AVAR LED ◀ 214 ▶	Kanlux REGIS ◀ 216 ▶	Kanlux REGIS 4LED ◀ 217 ▶	Kanlux NOTUS ◀ 218 ▶
						
Kanlux NOTUS 4LED ◀ 219 ▶	Kanlux TP STRONG ◀ 220 ▶	Kanlux TP SLIM LED ◀ 221 ▶	Kanlux TP SLIM TW LED ◀ 221 ▶	Kanlux MAH LED HI ◀ 222 ▶	Kanlux MAH LED N ◀ 223 ▶	Kanlux MAH PLUS 4LED ◀ 224 ▶
						
Kanlux MAH PLUS ◀ 225 ▶	Kanlux MEBA LED IP54 ◀ 226 ▶	Kanlux MEBA 4LED IP54 ◀ 226 ▶	Kanlux MEBA LED ◀ 227 ▶	Kanlux MEBA 4LED ◀ 227 ▶	Kanlux ALDO 4LED ◀ 228-229 ▶	Kanlux IPER LED ◀ 230-231 ▶
						
Kanlux BENO LED ◀ 232-233 ▶	Kanlux VARSO LED ◀ 234-235 ▶	Kanlux STIVI LED ◀ 236 ▶	Kanlux ORTE LED ◀ 237 ▶	Kanlux DABA PRO ◀ 238 ▶	Kanlux DABA N LED SMD ◀ 238 ▶	Kanlux TYBIA LED ◀ 239 ▶
						
Kanlux JURBA DL ◀ 240 ▶	Kanlux PIREAS DL ◀ 241 ▶	Kanlux FOGLER LED ◀ 242 ▶	Kanlux FOGLER DL ◀ 242 ▶	Kanlux SANSO LED ◀ 243 ▶	Kanlux MARC DL ◀ 243 ▶	Kanlux ERTON ◀ 244 ▶
						
Kanlux PLAFMIN ◀ 244 ▶	Kanlux HERMI ◀ 245 ▶	Kanlux MILO ◀ 245 ▶	Kanlux INES ◀ 246 ▶	Kanlux SANGA DL ◀ 246 ▶	Kanlux TUNA ◀ 247 ▶	Kanlux TURK ◀ 247 ▶



**LUMINAIRE
TECHNICHES
ET FONCTIONNELS**
PROTTOTTI
DECORATIVI
E DOMESTICI



Kanlux HIMA LED
◀ 248-249 ▶



Kanlux TIBERI PRO
◀ 250 ▶



Kanlux TIBERI PRO NT
◀ 251 ▶



Kanlux AREL LED
◀ 252 ▶



Kanlux MATEO ES
◀ 253 ▶



Kanlux IVIAN LED
◀ 253 ▶



Kanlux TAVO LED
◀ 254-255 ▶



Kanlux ROUNDA V2LED
◀ 256-257 ▶



Kanlux KATRO V2LED
◀ 258 ▶



Kanlux CARSA V2LED
◀ 260 ▶



Kanlux KANTI V2LED
◀ 261 ▶



Kanlux FL AGOR LED
◀ 262 ▶



Kanlux FL AGOR HI
◀ 263 ▶



Kanlux IQ-LED FL
◀ 264 ▶



Kanlux ANTEM LED
◀ 266 ▶



Kanlux STATO LED
◀ 267 ▶



Kanlux FL SONE SLR
◀ 268 ▶



Kanlux FL SOLNAR SLR
◀ 269 ▶



Kanlux STRETON LED
◀ 270 ▶



Kanlux HB PRO LED HI
◀ 272 ▶



Kanlux REKA LED
◀ 274 ▶



Kanlux BISO LED
◀ 275 ▶



Kanlux GARTO LED
◀ 275 ▶



Kanlux ZEWE EL
◀ 276 ▶



Kanlux BART EL
◀ 277 ▶



Kanlux LART EL
◀ 277 ▶



Kanlux DULI LED
◀ 278 ▶



Kanlux GLASI LED
◀ 279 ▶



Kanlux TAXI SMD
◀ 279 ▶



Kanlux TURRO LED
◀ 280 ▶



Kanlux GORDO N
◀ 281 ▶



Kanlux ROGER DL
◀ 281 ▶



Kanlux BERG AD
◀ 282 ▶



Kanlux BERG DL
◀ 282 ▶



Kanlux XARD DL
◀ 283 ▶



Kanlux MORO N
◀ 283 ▶



Kanlux ABETE LED
◀ 285 ▶



Kanlux PEVO
◀ 286 ▶



Kanlux LAVEN
◀ 287 ▶



Kanlux PRESO
◀ 288 ▶



Kanlux SELTO
◀ 289 ▶



Kanlux LIEGO
◀ 290 ▶

LUMINAIRES TECHNIQUES ET FONCTIONNELS PROTTOTTI DECORATIVI E DOMESTICI



Kanlux VIMO
◀ 291 ▶



Kanlux GORI
◀ 292 ▶



Kanlux VADRA
◀ 293 ▶



Kanlux INVO OP
◀ 294 ▶



Kanlux INVO TR
◀ 295 ▶



Kanlux STONO N
◀ 296 - 296 ▶



Kanlux USTI SP
◀ 298 ▶



Kanlux VORA
◀ 299 ▶



Kanlux GRIBLO 7 GR
◀ 300 ▶



Kanlux AKVEN LED
◀ 300 ▶



Kanlux GRL
◀ 301 ▶



Kanlux DASTO
◀ 302 ▶



Kanlux NASTO
◀ 302 ▶



Kanlux ACORD ATLI
◀ 304-305 ▶



Kanlux ACORD ATL2 GU10
◀ 306 ▶



Kanlux ACORD ATL3 GU10
◀ 306 ▶



Kanlux ACORD ATL4 GU10
◀ 307 ▶



Kanlux ACORD ATL5 GU10
◀ 307 ▶



Kanlux BTL LED
◀ 308 ▶



Kanlux BTLW LED
◀ 309 ▶



Kanlux TEAR N
◀ 310 ▶



Kanlux TEAR N RC
◀ 311 ▶



Kanlux TEAR N PADAPTOR
◀ 313 ▶

EQUIPEMENTS CONNECTES PRODOTTI SMART



Kanlux SMART
◀ 316 ▶



Kanlux SMART
◀ 316 ▶



Kanlux SMART
◀ 317 ▶



Kanlux SMART
◀ 318 ▶



Kanlux SMART
◀ 319 ▶



Kanlux SMART
◀ 319 ▶



Kanlux SMART
◀ 319 ▶

EQUIPEMENTS ELECTRIQUES MATERIALE ELETTRICO E ACCESSORI



Kanlux SQMOTION
◀ 322 ▶



Kanlux ALER-N
◀ 322 ▶



Kanlux ZONA MINI
◀ 323 ▶



Kanlux ZONA MINI WT
◀ 323 ▶



Kanlux SENTO-O
◀ 324 ▶



Kanlux SENSQUARE
◀ 324 ▶



Kanlux MERGE-WT
◀ 325 ▶



Kanlux SLICK JQ
◀ 325 ▶



Kanlux ALER JQ
◀ 326 ▶



Kanlux ALER MINI
◀ 326 ▶



Kanlux ZONA JQ-37
◀ 327 ▶

EQUIPMENTS ELECTRIQUES MATERIALE ELETTRICO E ACCESSORI



Kanlux ZONA ◀ 327 ▶	Kanlux MERGE JQ ◀ 328 ▶	Kanlux MARID JQ ◀ 328 ▶	Kanlux ROLF JQ ◀ 329 ▶			
Kanlux ROLF JQ ◀ 329 ▶	Kanlux ROLF JQ ◀ 330 ▶	Kanlux MERGE JQ ◀ 330 ▶	Kanlux MERGE ◀ 331 ▶	Kanlux MERGE ◀ 331 ▶	Kanlux SENTO ◀ 332 ▶	Kanlux SENZO ◀ 332 ▶
Kanlux AZ-10A ◀ 333 ▶	Kanlux CYBER ◀ 334 ▶	Kanlux STER TS-MF ◀ 334 ▶	Kanlux ADI ◀ 335 ▶	Kanlux POWELED ◀ 335 ▶	Kanlux CIRCO ◀ 336 ▶	Kanlux DRIVE LED ◀ 336 ▶
Kanlux SET ◀ 336 ▶	Kanlux WIR ZL ◀ 337 ▶	Kanlux TWISTER ◀ 337 ▶	Kanlux CYKLON ◀ 338 ▶	Kanlux GRIP ◀ 339 ▶	Kanlux STAN GP ◀ 339 ▶	Kanlux PIN W/US ◀ 339 ▶
Kanlux ZARK ◀ 340 ▶	Kanlux APO ◀ 340 ▶	Kanlux BR-GZ10 ◀ 340 ▶	Kanlux HLDR-E14 ◀ 341 ▶	Kanlux HLDR-E14 ◀ 341 ▶	Kanlux HLDR-E27 ◀ 341 ▶	Kanlux HLDR-E27 ◀ 342 ▶
Kanlux HLDR-E27 ◀ 342 ▶	Kanlux HLDR-G9 ◀ 342 ▶	Kanlux HLDR-GX53 ◀ 343 ▶	Kanlux HLDR-GZ10 ◀ 343 ▶	Kanlux HLDR-R75 ◀ 343 ▶	Kanlux ONTEC S ◀ 344 ▶	Kanlux ONTEC S ◀ 345 ▶
Kanlux ITECH ◀ 346 ▶	Kanlux ONTEC G ◀ 347 ▶	Kanlux ONTEC C ◀ 347 ▶	Kanlux ONTEC R ◀ 348 ▶	Kanlux PICTO G ◀ 349 ▶	Kanlux PICTO S ◀ 350 ▶	Kanlux IT ◀ 351 ▶

Kanlux





Kanlux
FACTORY

LUMINAIRES FABRICATION KANLUX
KANLUX FACTORY FIXTURES

Nos solutions sur-mesure peuvent être adaptées à vos besoins. Le soin porté à chaque détail et l'adéquation parfaite caractérisent les produits de fabrication de Kanlux. Découvrez-les dès aujourd'hui!

Le nostre soluzioni e i nostri prodotti possono essere ritagliati in base alle tue esigenze. L'attenzione a ogni dettaglio è ciò che caratterizza la produzione della Kanlux Factory. Scoprilà oggi stesso!



*Les données photométriques se trouvent sur le site web:
Dati fotometrici consultabili su:*

► [kanlux.com](https://www.kanlux.com)

ALIN LED

LUMINAIRE PROFILES LINAIRE LED ▶ PROFILI LINEARI LED

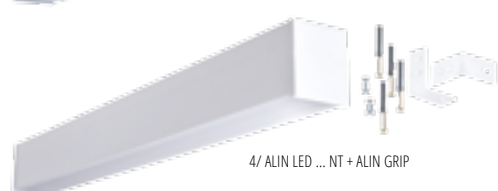
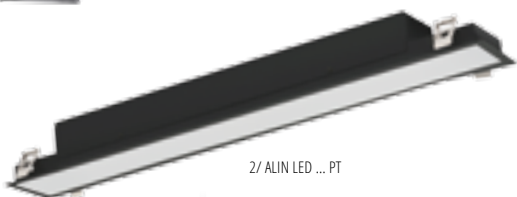

CINQ MODES DE POSE
5 VERSIONI

TROIS LONGUEURS:
3 LUNGHEZZE:
580MM
1140MM
1700MM

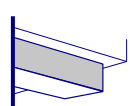

1/ SAILLIE MONTAGGIO IN SUPERFICIE

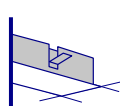

2/ A ENCASTRER MONTAGGIO A INCASSO

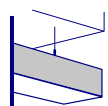

3/ SUSPENDU MONTAGGIO A SOSPENSIONE

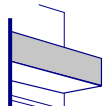

4/ MURAL MONTAGGIO A PARETE

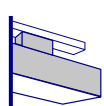

5/ SUR RAIL MONTAGGIO A BINARIO

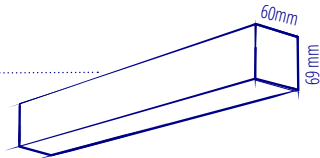

QU'EST-CE QUI NOUS DIFFÉRENCIE?

TROIS COLORIS DE FINITIONS
PROFILES
3 COLORI STANDARD
DISPONIBILI



BLANC BIANCO



NOIR NERO

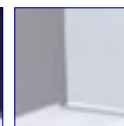

ARGENT ARGENTO



Kanlux ALIN LED est un produit créé avec le souci de la perfection. Il a été conçu par les designers de Kanlux, qui ont combiné leur esprit d'innovation avec 30 ans d'expérience. Composants de marque renommée et souci de la perfection assurent une esthétique et une durabilité pour agir pendant de nombreuses années. La largeur de gamme donne la possibilité de trouver le luminaire qui sied à chaque projet.



Une garantie de 5 ans accordée conformément aux termes de la déclaration de garantie disponible sur le site d'Internet www.kanlux.com



Kanlux Alin è un prodotto che è stato creato con l'attenzione ad ogni minimo dettaglio. È stato realizzato dai designer della Kanlux combinando l'innovazione a 30 anni di esperienza. Componenti di marca e la perfetta manodopera assicurano un'elevata qualità estetica e garantiscono durevolezza per molti anni. L'ampia gamma di modelli si attaglia alle esigenze ed ai bisogni più specifici.



Garanzia 5 anni secondo le condizioni e i termini reperibili sul sito [140 140 www.kanlux.com](http://www.kanlux.com)

CONFIGURATOR



Configurateur pour concevoir une installation.

Crea il tuo prodotto in base alle tue esigenze attraverso l'utile configuratore.

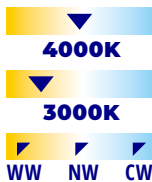

TEINTE DE COULEUR
OU SWITCH CCT
OPZIONALMENTE
DISPONIBILE
CON TEMPERATURA
KELVIN REGOLABILE

LEGENDE ► LEGENDA

AL	KANLUX ALIN LED
ALD	KANLUX ALIN LED DALI
ALC	CASAMBI READY
S	long profilé 580mm
M	long profilé 1140mm
L	long profilé 1700mm
S	puissance très basse / bassa potenza
L	puissance basse / bassa potenza
M	puissance medium / media potenza
H	puissance haute / alta potenza
WW	3000K Ra ≥ 80
NW	4000K Ra ≥ 80
TW	switch CCT / tunable white
MAT	diffuseur mat / diffusore opaco
MPR	diffuseur micropismatique / diffusore micropismatico
W	couleur du profilé: blanc / colore dell'involucro: bianco
B	couleur du profilé: noir / colore dell'involucro: nero
S	couleur du profilé: argent / colore dell'involucro: argento
NT	version saillie / montaggio in superficie
PT	version encastrable / montaggio a incasso
ALIN +ALIN CORD +ROPE	kit suspension / montaggio a sospensione
ALIN +ALIN NT GRIP	kit applique murale / montaggio a parete
RM	montage sur rail / Montaggio a binario
SE	version détecteur / Sensore di movimento
AS	optique asymétrique / ottica asimmetrica



QR CODE POUR RETROUVER TOUS LES CODES PRODUITS FACTORY / TROVA TUTTI I CODICI DEI PRODOTTI DI QUESTA FAMIGLIA



		MAT		MPR	
		WW (830)	NW (840)	WW (830)	NW (840)
SL	10W	1150lm	1300lm	1050lm	1200lm
SH	19W	2250lm	2550lm	2050lm	2350lm
MS	18W	2150lm	2400lm	2050lm	2250lm
ML	25W	2980lm	3250lm	2750lm	3000lm
MM	29W	3450lm	3900lm	3170lm	3600lm
MH	40W	4500lm	5050lm	4150lm	4650lm
LL	33W	4100lm	4550lm	3750lm	4150lm
LH	52W	5600lm	6300lm	5150lm	5800lm

COSA CI CONTRADDISTINGUE?

COULEUR FINITION SUR DEMANDE COLORE CUSTOMIZZABILE

DEUX TYPES DE DIFFUSEUR 2 DIFFUSORI

MODULE LED HAUTE QUALITÉ MODULI LED DI ELEVATA QUALITÀ

LEDS ET DRIVERS DE MARQUE OSRAM/TRIDONIC COMPONENTI OSRAM E TRIDONIC

DRIVER DALI EN OPTION DRIVER DALI DISPONIBILE OPZIONALMENTE



MAT (OPAL) OPACO



MICROPISMATIQUE MICROPRISMATICO



ALIN LED LINE

PROFILES EN LIGNES CONTINUES ► LAMPADA LED

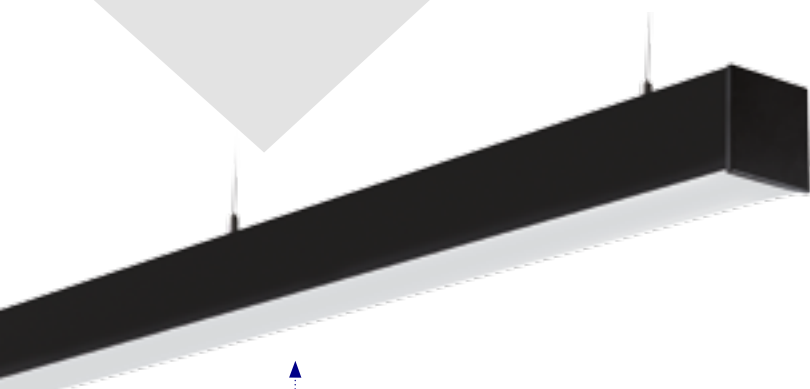

FACTORY



Kanlux ALIN LED LINE est un système d'éclairage en ligne continue conçu et fabriqué avec le plus grand soin. Cette solution permet de créer de longues lignes continues avec des formes linéaires ou sur mesure. La conception spécifique de ALIN LED à un projet sur mesure permet de créer un effet unique pour chaque projet.



Une garantie de 5 ans accordée conformément aux termes de la déclaration de garantie disponible sur le site d'Internet www.kanlux.com



Kanlux Alin è un prodotto che è stato creato con l'attenzione ad ogni minimo dettaglio. È stato realizzato dai designer della Kanlux combinando l'innovazione a 30 anni di esperienza. Componenti di marca e la perfetta manodopera assicurano un'elevata qualità estetica e garantiscono durevolezza per molti anni. L'ampia gamma di modelli si attaglia alle esigenze ed ai bisogni più specifici.



Garanzia 5 anni secondo le condizioni e i termini reperibili sul sito www.kanlux.com

CONFIGURATOR



Configurateur pour concevoir une installation.

Crea il tuo prodotto in base alle tue esigenze attraverso l'utile configuratore.



POSSIBILITE DE LIGNE SUR MESURE
POSSIBILITA' ILLIMITATE
POSSIBILITA' DI LINEA
NELLA FORMA
E IN LUNGHEZZA



LIGNE ALIN LED AVEC ELEMENTS ECLAIRANT:
LF/LM/LL JONCTIONS: X/T/L
CONNECTEURS ACTIFS: LTX1/LTX1C/LTX2C/LTX1E
ALIN LED LINE PER PROGETTI UNICI BASATI SU
ELEMENTI DIFFERENTI: LF / LM / LL
CONNETTORIPASSIVI: X / T / L
CONNETTORI ATTIVI: LTX1 / LTX1C / LTX2C / LTX1E

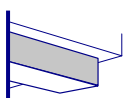

SAILLIE IN SUPERFICIE

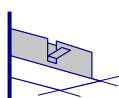

ENCASTRE DA INCASSO

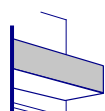

MURAL MONTAGGIO A PARETE

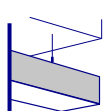

SUSPENSION A SOSPENSIONE

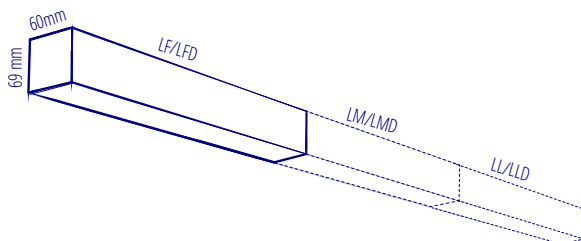

PROFILES ACTIFS
4 CONNETTORI
ATTIVI:
LTX1
LTX1C
LTX2C
LTX1E

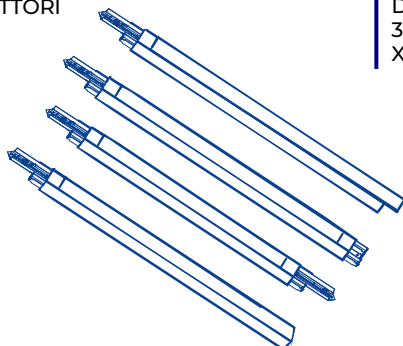

TROIS CONNECTEURS
DE JONCTION:
3 CONNETTORI PASSIVI:
X/T/L

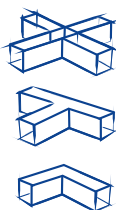

TEINTE 3000/4000
OU CCT
2 TEMPERATURE DI
COLORE E OPZIONALMENTE
COLORE REGOLABILE



LEGENDE ► LEGENDA

LF	1137mm élément de départ / 1137mm componente iniziale
LM	1124mm élément milieu/ 1124mm componente intermedio
LL	1137mm élément de fin / 1137mm componente terminale
LFD	1137mm élément de départ dali / 1137mm componente iniziale dali
LMD	1124mm élément milieu dali / 1124mm componente intermedio dali
LLD	1137mm élément de fin dali / 1137mm componente finale dali
L-X, LD-X	connecteur en X, dali / xconnectore dali a X
L-L, LD-L	connecteur en L, dali / connettore dali a L
L-T, LD-T	connecteur en T, dali / connettore dali a T
LTX1	connecteur LED ligne → raccord / long straight connector → connector (LTX)
LTX1C	connecteur LED raccord → ligne / LTX connector → long straight connector
LTX2C	connecteur LED raccord → raccord / LTX connector → LTX connector
LTX1E	élément led fin / elemento di connessione terminale
S	puissance très basse / potenza extra bassa
L	puissance basse / bassa potenza
M	puissance médium / potenza media
H	puissance haute / alta potenza
WW	3000K Ra ≥ 80
NW	4000K Ra ≥ 80
TW	tunable white
MAT	diffuseur mat opal / diffusore opalino
MPRM	diffuseur microprism / diffusore microprismatico
W	couleur du profilé: blanc / involucro lampada bianco
B	couleur du profilé noir / involucro lampada nero
S	couleur du profilé: argent / involucro lampada argento
NT	montage saillie / montaggio in dupeficie

PT	montage encastré / montaggio a incasso
ALIN +ALIN NT GRIP	montage mural / montaggio a parete
ALIN +CORD +ROPE	montage suspendu / montaggio a sospensione

	MAT		MPR	
	WW (830)	NW (840)	WW (830)	NW (840)
MS	18W	2150lm	2400lm	2050lm
ML	25W	2980lm	3250lm	2750lm
MM	29W	3450lm	3900lm	3170lm
MH	40W	4500lm	5050lm	4150lm

(lm)



MS	18W	2150lm	2400lm	2050lm	2250lm
ML	25W	2980lm	3250lm	2750lm	3000lm
MM	29W	3450lm	3900lm	3170lm	3600lm
MH	40W	4500lm	5050lm	4150lm	4650lm

DRIVER DALI ET CASAMBI
READY EN OPTION
OPZIONALMENTE DISPONIBILI
CON DRIVER DALI E CASABI

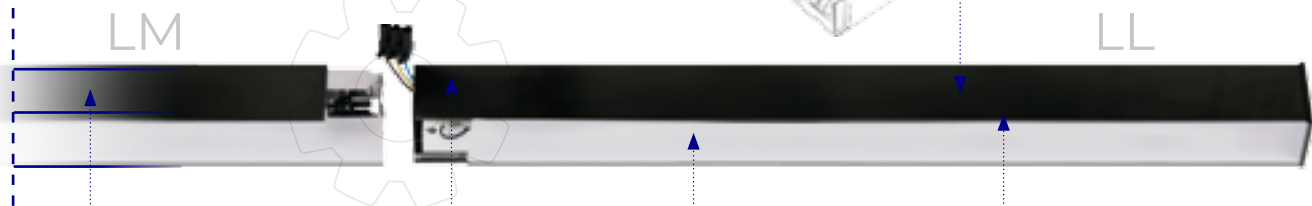

COULEUR FINITION
SUR DEMANDE
COLORE INVOLUCRO
LAMPADA
CUSTOMIZZABILE

TROIS COLORIS
DE FINITIONS
PROFILES
3 COLORI
STANDARD

DEUX TYPES
DE DIFFUSEUR
2 TIPI DI
DIFFUSORE

OPTION AVEC LE DÉTECTEUR
DE MOUVEMENT À MICRO
-ONDES INTÉGRÉ
OPZIONE CON
SENSORE INTEGRATO

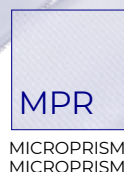
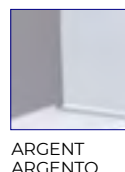
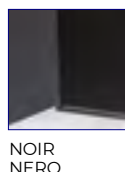

Kanlux

ALIN 4LED

PROFILES LINEAIRES POUR TUBES LED T8 ► ALIN CON TUBI T8 LED SOSTITUIBILI



1/ ALIN 4LED

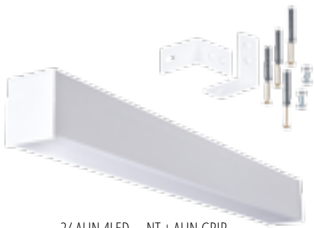

2/ ALIN 4LED ... NT + ALIN GRIP

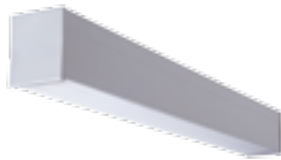

3/ ALIN 4LED ... NT

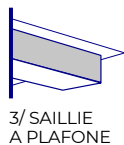

3/ SAILLIE A PLAFONE

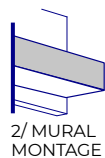

2/ MURAL MONTAGE A MURO

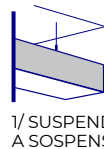

1/ SUSPENDU A SOSPENSIONE

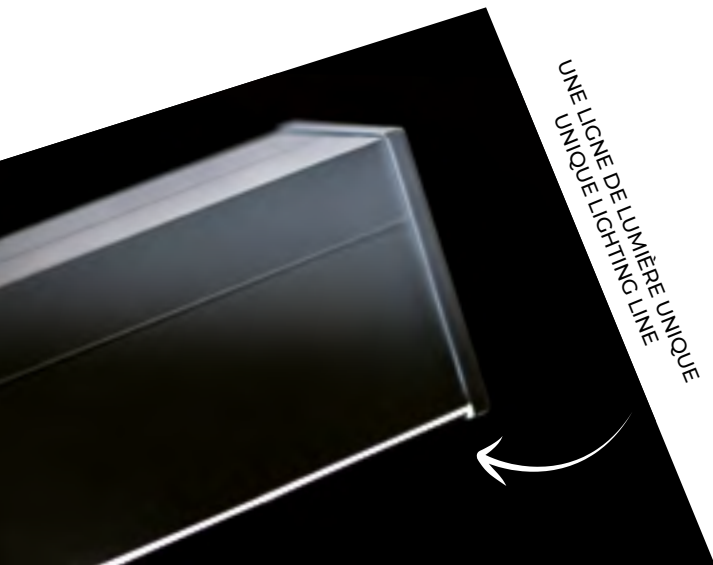

UNE LIGNE DE LUMIERE UNIQUE
UNIQUE LIGHTING LINE

Kanlux FACTORY



Le Kanlux ALIN 4LED est un appareil adapté aux tubes led T8. Il est une alternative pour ceux qui apprécient de recourir à une source de lumière remplaçable. La marque reconnue des composants électroniques et une fabrication soignée assurent l'esthétique et la pérenité de fonctionnement pour de nombreuses années. Le large de gamme offre la possibilité d'adapter le dispositif aux besoins de chaque projet.



Une garantie de 5 ans accordée conformément aux termes de la déclaration de garantie disponible

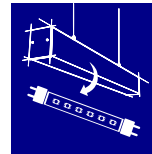

Kanlux ALIN 4LED è un apparecchio compatibile con tubi T8 LED. È la soluzione ideale per coloro che desiderino sostituire i tubi led. L'elevato standard di produzione conferisce durevolezza al prodotto che è caratterizzato da un'estetica minimale ed elegante. L'ampia gamma di modelli e le possibilità di customizzazione lo rendono adatto a una moltitudine di progetti.

Garanzia di 5 anni secondo le condizioni e i termini reperibili sul sito: www.kanlux.com

CONFIGURATOR



Configurateur pour concevoir une installation.

Crea il tuo prodotto in base alle tue esigenze attraverso l'utile configuratore.



COULEUR SUR DEMANDE
COLORE CUSTOMIZZABILE



QU'EST-CE QUI NOUS DIFFÉRENCIE?

TROIS LONGUEURS:
TRE LUNGHEZZE:
633MM
1244MM
1544MM

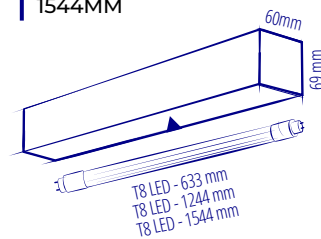

T8 LED - 633 mm
T8 LED - 1244 mm
T8 LED - 1544 mm

LEGENDE ► LEGENDA

AL 4LED	KANLUX ALIN 4LED
MAT	diffuseur mât opal / diffusore opaco
MPR	diffuseur microprismatique / diffusore microprismatico
W	couleur du boîtier: blanc / colore dell'involucro: bianco
B	couleur du profilé: noir / colore dell'involucro: nero
S	couleur du profilé: argent / colore dell'involucro: argento
NT	version saillie / montaggio in superficie
ALIN +ALIN NT GRIP	montage mural / montaggio a parete
ALIN +CORD +ROPE	wersja wisząca / suspended mounted
SE	version détecteur / sensore di movimento



QR CODE POUR RETROUVER
TOUS LES CODES PRODUITS
FACTORY / TROVA TUTTI
I CODICI DEI PRODOTTI
DI QUESTA FAMIGLIA



BLANC
BIANCO

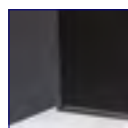

NOIR
NERO

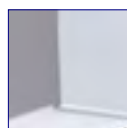

ARGENT
ARGENTO

TROIS COLORIS DE
FINITIONS PROFILÉS
TRE FINITURE DI
COLORE DISPONIBILI

COSA CI CONTRADDISTINGUE?

RECOMMENDATION:
TUBE T8 IQ LED DE KANLUX
LAMPADA SOSTITUIBILE
CONSIGLIATI TUBI KANLUX

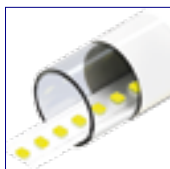

DEUX TYPES DE DIFFUSEUR
DUE TIPI DI DIFFUSORE

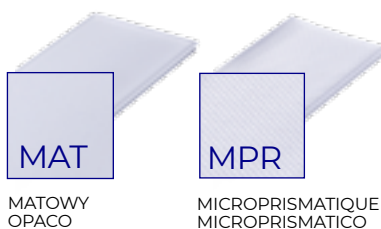

MAT

MATOWY
OPACO

MPR

MICROPRISMATIQUE
MICROPRISMATICO

OPTION AVEC LE DÉTECTEUR
DE MOUVEMENT À MICRO-
ONDES INTÉGRÉ
OPZIONE CON
SENSORE INTEGRATO



ALIN 4LED LINE

LIGNE CONTINUE EN TUBES LED T8 ▶ ALIN CON TUBI T8 LED SOSTITUIBIL

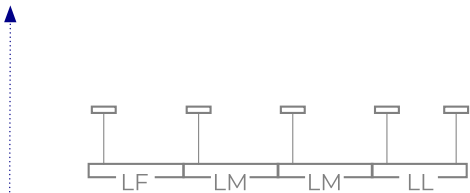
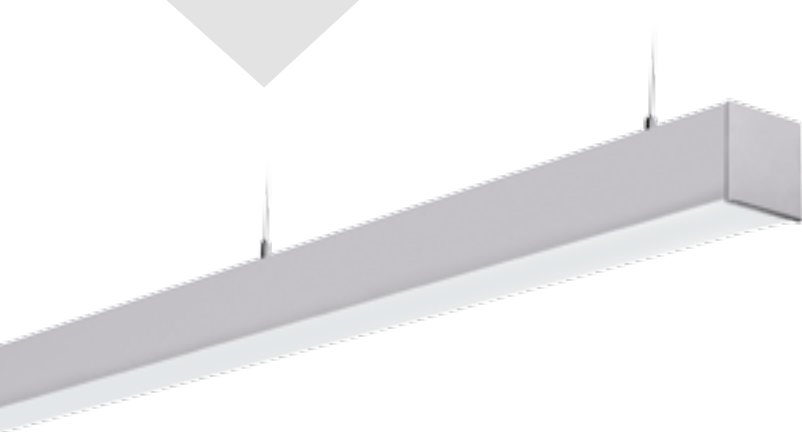

POSSIBILITE DE LIGNE
SUR MESURE
POSSIBILITA' DI LINEA
SU MISURA



LIGNE CONTINUE
ELEMENTS 1230 MM
POSSIBILITA' DI CONGIUNGERE
IN UNA LINEA ININTERROTTA
IL MODELLO ALIN 4LED
DA 1230MM

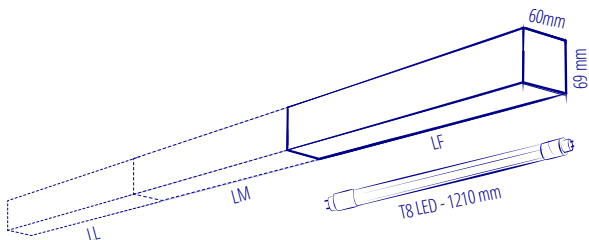
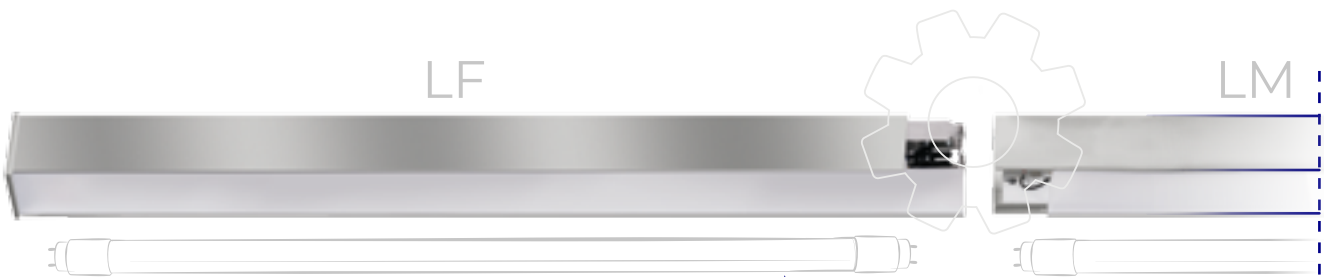
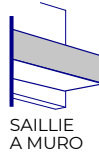
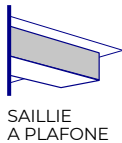

RECOMMENDATION:
TUBE T8 IQ LED DE KANLUX
LAMPADA SOSTITUIBILE
CONSIGLIATI TUBI KANLUX

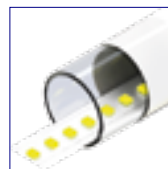

Kanlux ALIN 4LED LINE est une nouveauté complète. Une solution unique qui utilise des luminaires avec tubes led interchangeables T8LED afin de créer la ligne d'éclairage à la mode et fonctionnelle. Longueur illimitée de la ligne, le design universel, adapté à vos besoins et la liberté de choix et en modifiant les paramètres de la source lumineuse à tout moment pendant son fonctionnement, offre la possibilité de créer un programme de système d'éclairage.



Une garantie de 5 ans accordée conformément aux termes de la déclaration de garantie disponible sur le site d'Internet www.kanlux.com

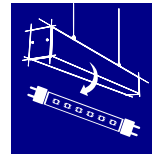

Kanlux ALIN 4LED e' un apparecchio compatibile con tubi T8 LED. E la soluzione ideale per coloro che desiderino sostituire i tubi led. L'elevato standard di produzione conferisce durevolezza al prodotto che e' caratterizzato da un'estetica minimale ed elegante. L'ampia gamma di modelli e le possibilita' di customizzazione lo rendono adatto a una moltitudine di progetti.

Garanzia di 5 anni secondo le condizioni e i termini reperibili sul sito: www.kanlux.com

CONFIGURATOR



Configurateur pour concevoir une installation.

Crea il tuo prodotto in base alle tue esigenze attraverso l'utile configuratore.

LEGENDE ► LEGENDA

LF	1364mm élément de départ / 1364mm primo componente
LM	1221mm élément milieu / 1221mm componente intermedio
LL	1097mm élément de fin / 1097mm componente finale
MAT	diffuseur mat / diffusore opalino
MPRM	diffuseur microprismatique / diffusore microprismatico
W	couleur du profilé: blanc / colore dell'involucro: bianco
B	couleur du profilé: noir / colore dell'involucro: nero
S	couleur du boîtier: argent / colore dell'involucro: argento
NT	version saillie / montaggio in superficie
ALIN +CORD +ROPE	version suspendue / montaggio a sospensione
ALIN +ALIN NT GRIP	montage mural / montaggio a parete



TROIS COLORIS
DE FINITIONS
PROFILES
TRE FINITURE
DI COLORE
DISPONIBILI

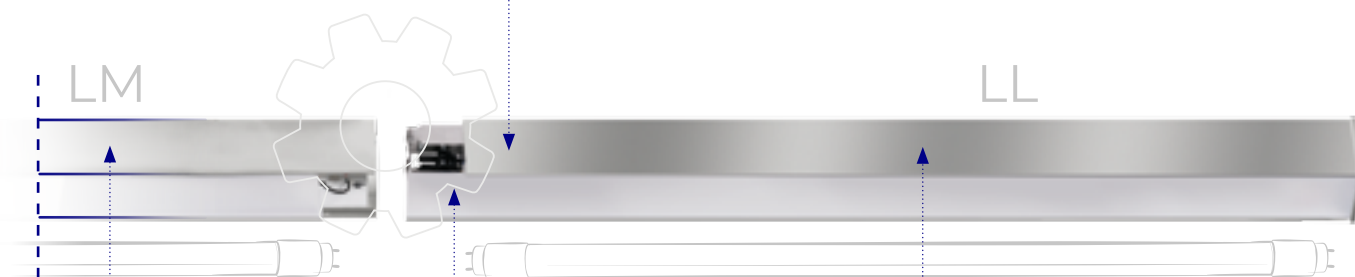

COULEUR FINITION
SUR DEMANDE
COLORE
DELL'INVOLUCRO
CUSTOMIZZABILE



OPTION AVEC LE DÉTECTEUR
DE MOUVEMENT
À MICRO-ONDES INTÉGRÉ
2 TIPI DI DIFFUSORE

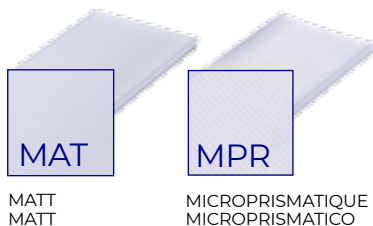

OPTION AVEC LE DÉTECTEUR
DE MOUVEMENT
À MICRO-ONDES INTÉGRÉ
SENSORE DI MOVIMENTO
INTEGRATO-OPZIONALE



OFIS S LED

LUMINAIRE LED POUR BUREAU ► PALFONIERA DA UFFICIO A LED



1/ OFIS S LED ... NT...N4



2/ OFIS S LED ... PT...P1



1/ OFIS S LED ... NT...N3



2/ OFIS S LED ... PT...P3

DEUX
VERSIONS
DUE
VERSIONI

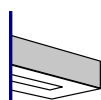

1/ SAILLIE
A INCASSO

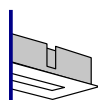

2/ ENCASTRE
A PLAFONE

DEUX COULEURS
DE CAISSONS
DUE COLORI
DELL'INVOLUCRO



BLANC
BIANCO

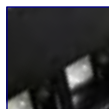

NOIR
NERO

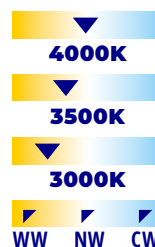

TEINTES
AU CHOIX
OU CCT
TEINTE
OPZIONALMENTE
DISPONIBILE
CON
TEMPERATURA
KELVIN
REGOLABILE



Kanlux OFIS S LED est une gamme de luminaires destinés principalement aux bureaux et open-space. Le caisson métallique simple et plat rend le luminaire très élégant de sorte qu'il s'intègre parfaitement au plafond. La possibilité de choisir le caisson, la couleur, le diffuseur et la température de couleur le rend polyvalent. La nouvelle génération de grilles réduit l'effet d'éblouissement à un très faible niveau.

Une garantie de 5 ans accordée conformément aux termes de la déclaration de garantie disponible sur le site d'Internet www.kanlux.com

Kanlux OFIS S LED è una famiglia di lampade concepite espressamente per ambienti lavorativi. Il design minimalista si integra perfettamente con l'ambiente. La possibilità di scegliere differenti colori la rende estremamente versatile.

Garanzia di 5 anni secondo le condizioni e i termini reperibili sul sito: www.kanlux.com

CONFIGURATOR



Configurateur pour concevoir une installation.

Crea il tuo prodotto in base alle tue esigenze attraverso l'utile configuratore.

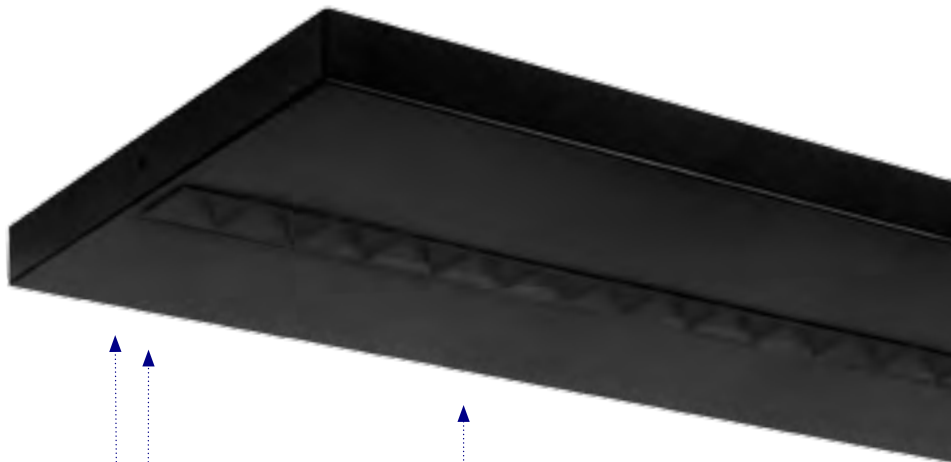

LEGENDE ► LEGENDA

OS	OFIS S LED
OSD	OFIS S LED DALI
OSC	OFIS S LED CASAMBI READY
40W	puissance [W] version MPR / potenza [W] della versione microprismatica
S	puissance très basse 22W / potenza extra bassa 22W
L	puissance basse 31W / bassa potenza 31W
M	puissance medium 39W / potenza media 39W
H	puissance haute 49W / alta potenza 49W
5D	optique lentille 50° / sistema con ottiche a 50°
8D	optique lentille 80° / sistema con ottiche a 80°
WW/830	Ra≥80 3000K
WN/835	Ra≥80 3500K
NW/840	Ra≥80 4000K
TW	TUNABLE WHITE / TUNABLE WHITE (CCT)
MPRM	diffuseur microprismatique / diffusore microprismatico
RST	grille / raster
W	couleur du boîtier: blanc/ colore dell'involucro: bianco
B	couleur du profilé: noir / colore dell'involucro: nero
N1	version saillie 600x600mm / montaggio in superficie 600x600mm
N3	version saillie 1200x300mm / montaggio in superficie 1200x300
P1	version encastrable 595x595mm / incasso 5x9x595mm

P3	version encastrable 1195x295mm / incasso 1195x295mm
SE	version détecteur HF / versione con sensore di movimento
EM	version éclairage secours / versione con emergenza integrata



QR CODE POUR RETROUVER
TOUS LES CODES PRODUITS
FACTORY / TROVA TUTTI
I CODICI DEI PRODOTTI
DI QUESTA FAMIGLIA

S/W	3200lm	UGR ≤ 14
S/B	2800lm	UGR ≤ 14
L/W	4300lm	UGR ≤ 15
L/B	3800lm	UGR ≤ 15
M/W	5400lm	UGR ≤ 16
M/B	4800lm	UGR ≤ 16
H/W	6300lm	UGR ≤ 16
H/B	5600lm	UGR ≤ 16

DIMENSIONS
DIMENSIONE

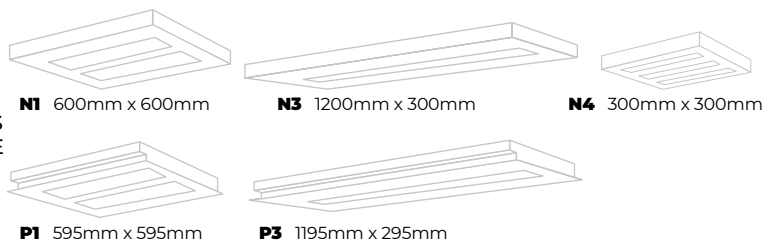

DEUX VERSIONS DU
SYSTÈME OPTIQUE
DUE OTTICHE



LENTILLE
LENTE PIU'
STRETTA



LENTILLE
LENTE PIU'
AMPIA

COMPOSANTS LED
ET DRIVER
OSRAM/TRIDONIC
COMPONENTI OSRAM E TRIDONIC



DIFFUSEUR
MICROPRISMATIQUE
MICROPRISMATICO



NOUVELLE GÉNÉRATION
DE GRILLES POUR
RÉDUIRE L'ÉBLOUISSEMENT
NUOVA GENERAZIONE
DI GRIGLIO PER DIMINUIRE
L'ABBAGLIAMENTO

DRIVER DALI ET
CASAMBI READY
EN OPTION
OPZIONALMENTE
DISPONIBILI CON DRIVER
DALI E CASABI

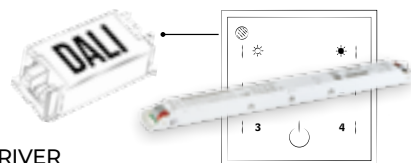

HIERRO LED

OPRAWA BIUROWA LED ► LED OFFICE FIXTURE

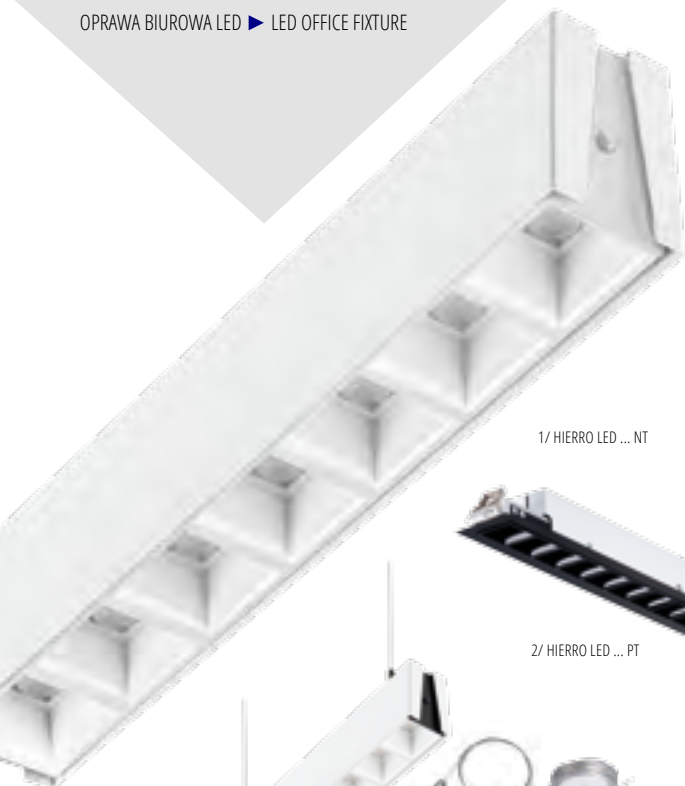

1/ HIERRO LED ... NT



2/ HIERRO LED ... PT



3/ HIERRO LED ... NT + ALIN CORD + ROPE



4/ HIERRO LED ... NTFX



5/ HIERRO LED ... RM
6/ HIERRO LED ... RMFX



SIX VERSIONS
SIX VERSIONS

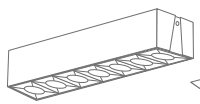

1/ SAILLIE MONTAGGIO IN SUPERFICIE

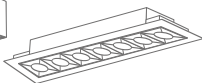

2/ ENCASTRE MONTAGGIO A INCASSO

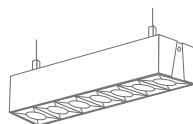

3/ SUSPENSIONS MONTAGGIO A SOSPENSIONE

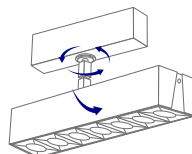

4/ SAILLIE ORIENTABLE FLEX 340° 90° MONTAGGIO IN SUPERFICIE FLEX ORINTABILE SU DUE ASSI DI 340° E 90°

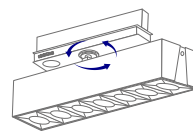

5/ SUR RAIL ORIENTABLE 340° MONTAGGIO IN SUPERFICIE FLEX ORINTABILE SU DUE ASSI DI 340° E 90°

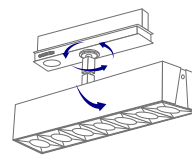

6/ SUR RAIL ORIENTABLE FLEX 340° 90° MONTAGGIO IN SUPERFICIE FLEX ORINTABILE SU DUE ASSI DI 340° E 90°



HIERRO est une nouvelle gamme de luminaires Kanlux avec une forme minimaliste et élégante en accord avec les nouvelles tendances en matière de design architectural. Cette solution technique est répandue pour l'éclairage des espaces de bureaux mais aussi les surfaces de vente, comme éclairage principal ou comme éclairage d'appoint. Ses performances lumineuses permettent un éclairage utile, attrayant et économe en énergie.

Garantie de 5 ans selon les termes de la garantie, disponible sur notre site à l'adresse suivante site web: www.kanlux.com

HIERRO è una nuova famiglia di apparecchi d'illuminazione nella gamma Kanlux. È minimalista e la forma elegante segue le ultime tendenze in progettazione architettonica. La soluzione elegante è ampiamente utilizzata negli uffici moderni, nei negozi e spazi loft come base, aggiuntivi o illuminazione d'accento. Lo spettro dei prodotti è completo di una varietà di controlli opzioni. Ciò rende possibile l'implementazione meno efficiente dal punto di vista energetico e avanzato sistemi di illuminazione che forniscono attraenti effetti luminosi.

Garanzia di 5 anni secondo le condizioni e i termini reperibili sul sito: www.kanlux.com

CONFIGURATOR



Configurateur pour concevoir une installation.

Crea il tuo prodotto in base alle tue esigenze attraverso l'utile configuratore.

3 DIMENSIONS
3 SIZE



S 43x65x290mm



M 43x65x570mm



L 43x65x850mm

LEGENDE ► LEGENDA

HR	HIERRO LED
HRD	HIERRO LED DALI
HRC	HIERRO LED CASAMBI READY
WW/830	Ra≥80 3000K
WN/835	Ra≥80 3500K
NW/840	Ra≥80 4000K
TW	version TUNABLE WHITE / versione: TUNABLE WHITE / Bianco sintonizzabile (CCT)
W	couleur de caisson blanc / colore dell'involucro: bianco
B	couleur de caisson noir / colore dell'involucro: nero
NT	version saillie / montaggio in superficie
PT	version encastrée / montaggio a incasso
HIERRO +ALIN CORD +ROPE	version suspendue / versione in sospensione
RM	version pour montage sur rail / versione da montare su binario
FX/FLEX	réglage supplémentaire de l'angle (sur demande) / regolazione angolare aggiuntiva (su ordine individuale)
S	longueur 300mm / lunghezza 300mm
M	longueur 600mm / lunghezza 600mm
L	longueur 900mm / lunghezza 900mm
SL	paramètres / parametri 9W 1250lm 300mm version / versione NT, PT, RM
SH	paramètres / parametri 14W 1700lm 300mm version / versione NT, PT, RM
ML	paramètres / parametri 18W 2450lm 600mm version / versione NT, PT
MM	paramètres / parametri 23W 3000lm 600mm version / versione NT, PT, RM
MH	paramètres / parametri 28W 3450lm 600mm version / versione NT, PT, RM
LL	paramètres / parametri 23W 3150lm 900mm version / versione NT, PT, RM
LM	paramètres / parametri 32W 4200lm 900mm version / versione NT, PT, RM
LH	paramètres / parametri 42W 5150lm 900mm version / versione NT, PT, RM



QR CODE POUR RETROUVER TOUS LES CODES PRODUITS FACTORY / TROVA TUTTI I CODICI DEI PRODOTTI DI QUESTA FAMIGLIA

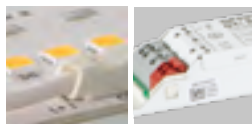

LED ET DRIVERS OSRAM / TRIDONIC BRANDED
COMPONENTI OSRAM E TRIDONIC



NOUVELLE GÉNÉRATION DE RASTER LIMITE L'EFFET D'ÉBLOUISSEMENT

UNA NUOVA GENERAZIONE DI FILTRI ANTIABBLIA-MENTO

DRIVER DALI ET CASAMBI READY EN OPTION / OPZIONALMENTE DISPONIBILI CON DRIVER DALI E CASABI



DEUX COULEURS DE CAISSONS ET VERSIONS MIXTES SUR COMMANDE
DUE COLORI DELL'INVOLUCRO



BLANC
BIANCO

NOIR
NERO

BLANC/NOIR
WHITE/BLACK



TROIS TEINTES AU CHOIX OU CCT OPZIONALMENTE DISPONIBILE CON TEMPERATURA KELVIN REGOLABILE

OPZIONALMENTE DISPONIBILE CON TEMPERATURA KELVIN REGOLABILE

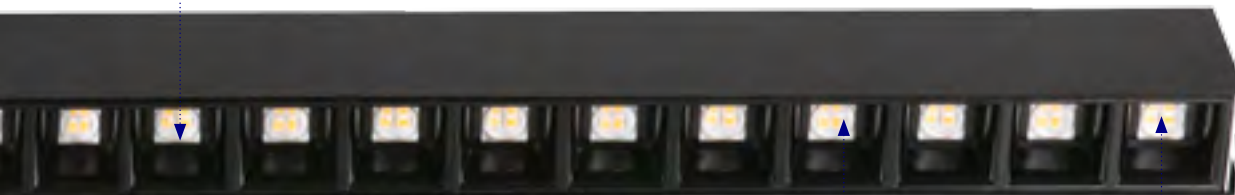
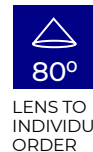

FUTURIO LED

REGLETTES LED ETANCHES ► PLAFONIERA STAGNA LED



Kanlux FACTORY



Le Kanlux FUTURIO LED est une gamme de luminaires étanches qui sont issus de la fabrication Kanlux. Ils se caractérisent par une grande qualité de finition et des paramètres techniques optimum. FUTURIO LED est également rapide et facile à installer. Une large gamme de modèles permet d'adapter l'appareil aux besoins de chaque projet. Des versions spéciales sont également disponibles: pour les applications à haute température ou avec un flux lumineux élevé.

Une garantie de 5 ans accordée conformément aux termes de la déclaration de garantie disponible

Kanlux FUTURIO LED è una famiglia di lampade stagne destinate ad usi professionali. Si distinguono per l'alta qualità della manifattura e per i parametri di efficienza luminosa. Un'ampia gamma di modelli permette a queste lampade di essere impiegate in ambiti diversi ed in ambienti con elevate temperature o dove è richiesta molta potenza.

Garanzia di 5 anni secondo le condizioni e i termini reperibili sul sito: www.kanlux.com

CONFIGURATOR



Configurateur pour concevoir une installation.

Crea il tuo prodotto in base alle tue esigenze attraverso l'utile configuratore.

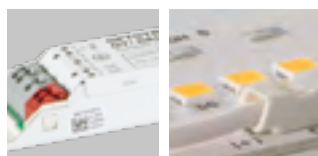

LED ET DRIVERS OSRAM/TRIDONIC
COMPONENTISTICA OSRAM E TRIDONIC

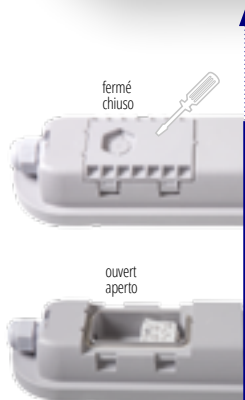

RACCORDEMENT RAPIDE
INSTALLAZIONE SENZA NECESSITA' DI ALCUNO STRUMENTO



PATTES REGLABLES
SUPPORTO SCORREVOLE

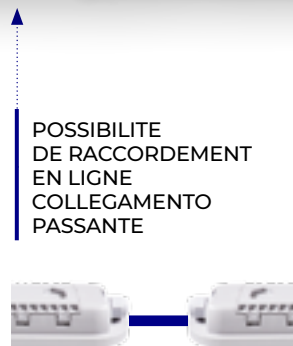

POSSIBILITE DE RACCORDEMENT EN LIGNE
COLLEGAMENTO PASSANTE

LEGENDE ► LEGENDA

FT	FUTURIO LED
FTD	FUTURIO LED DALI
FTC	CASAMBI READY
26W - 73W	puissance [W] / potenza [W]
840	Ra≥80 4000K
OPL	diffuseur opal / diffusore opalino
RYF	diffuseur prismatique / diffusore microprismatico
INT	lentille diffusion intensive / angolo di rifrazione stretto
ASY	lentille diffusion asymétrique / angolo di rifrazione asimmetrico
FTHL	version spéciale flux élevé / versione speciale ultrapotente
FTHT	version spéciale température élevée / versione speciale per ambienti con elevate temperature
SCF	option fonction corridor / opzione base



QR CODE POUR RETROUVER
TOUS LES CODES PRODUITS
FACTORY / TROVA TUTTI
I CODICI DEI PRODOTTI
DI QUESTA FAMIGLIA



DEUX LONGUEURS
DUE LUNGHEZZE

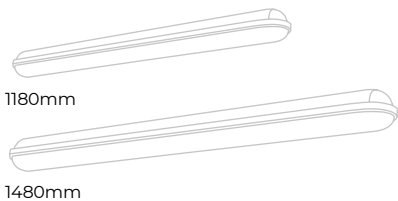

DRIVER DALI
ET CASAMBI
READY EN OPTION
/ OPZIONALMENTE
DISPONIBILI CON
DRIVER DALI E
CASABI

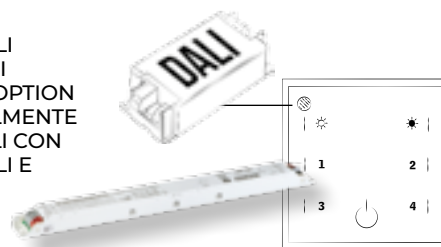

IP 65
IK 08



DEUX MODELES LENTILLES S
DUE TIPOLOGIE DI LENTI



INTENSE

VERSION INTENSIVE
ANGOLO RIFRAZIONE
STRETTO



ASY

VERSION ASYMÉTRIQUE
ANGOLO RIFRAZIONE
ASIMMETRICO

DEUX DIFFUSEURS
DUE DIFFUSORI



RYF

PRISMATIQUE
DIFFUSORE
MICROPRISMATICO



OPL

OPAL
DIFFUSORE
OPALINO

ADTR

CADRE SAILLIE ► CORNICE A PLAFONE



Les cadres saillies ADTR servent à installer en version saillie tout panneau LED, comme BRAVO ou BLINGO. La conception soudé tout-en-un du cadre dispense des opérations de montage fastidieuses. Ces cadres disponibles en différents modules assurent une compatibilité avec 99,9% des panneaux LED du marché, de type backlite ou edgelite.

La famiglia di cornici universali ADTR permette di montare in superficie pannelli led come i nostri modelli Bravo e Blingo. La struttura unica e preassemblata non solo e' esteticamente pregevole ma consente di risparmiare tempo durante l'installazione. Le differenti dimensioni e forme la rendono compatibile con il 99,9% dei pannelli Led edge e backlitgh presenti sul mercato.

LEGENDE ► LEGENDA

ADTR	cadre h.45mm / adattatore
ADTR-H	cadre h.65mm / cornice + alta
ADTR-H 76MM	cadre h.76mm / cornice + alta da 76mm
ADTR-S	cadre SLIM h.45mm / adattatore SLIM
ADTR-S-H	cadre SLIM h.65mm / adattatore SLIM altezza 76mm
W	couleur cadre: blanc / colore bianco
B	couleur cadre: noir / colore nero
S	couleur cadre: argent / colore argento

TROIS
MODULES
TRE
MODELLI

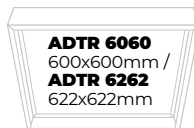

ADTR 12030 B	27614	5905339276148
ADTR 12030 SR	27612	5905339276124
ADTR 12030 W	27611	5905339276117
ADTR 3060 B	29842	5905339298423
ADTR 3060 SR	29841	5905339298416
ADTR 3060 W	29840	5905339298409
ADTR-H 3060 B	33394	5905339333940
ADTR-H 3060 SR	33395	5905339333957
ADTR-H 3060 W	33393	5905339333933
ADTR 6060 B	27615	5905339276155
ADTR 6060 SR	27610	5905339276100
ADTR 6060 W	27613	5905339276131
ADTR 6262 B	33430	5905339334305
ADTR 6262 SR	33431	5905339334312
ADTR 6262 W	33432	5905339334329
ADTR-H 12030 B	33391	5905339333919
ADTR-H 12030 SR	33392	5905339333926
ADTR-H 12030 W	33390	5905339333902
ADTR-H 6060 B	29845	5905339298454
ADTR-H 6060 SR	29844	5905339298447
ADTR-H 6060 W	29843	5905339298430
ADTR-H 6262 B	33433	5905339334336
ADTR-H 6262 SR	33434	5905339334343
ADTR-H 6262 W	33435	5905339334350
ADTR-H 76MM 6060 W	33398	5905339333988
ADTR-H 76MM 6262 B	33437	5905339334374
ADTR-H 76MM 6262 SR	33438	5905339334381
ADTR-H 76MM 6262 W	33436	5905339334367
ADTR-S 6060 W	27616	5905339276162
ADTR-S-H 6060 W	27617	5905339276179

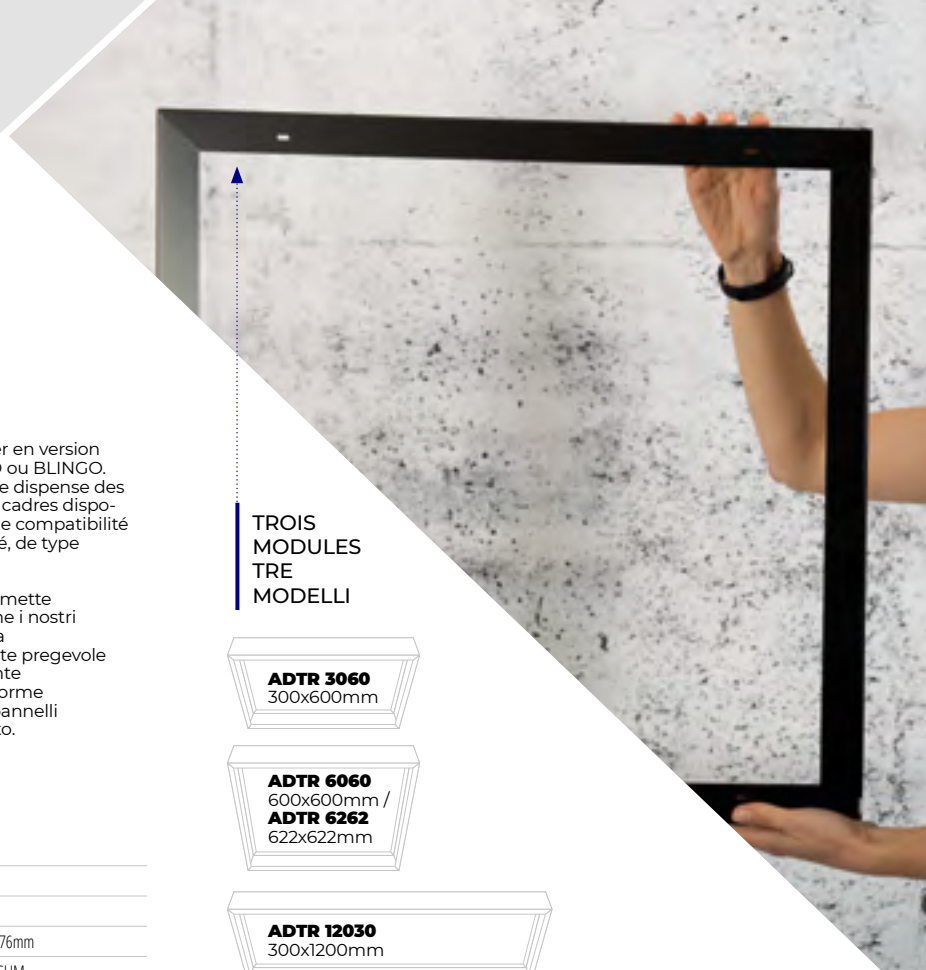

Kanlux

ADTR

CADRE SAILLIE ► CORNICE A PLAFONE



TROIS HAUTEURS
TRE ALTEZZE



ADTR
hauteur
45mm /
altezza
45mm



ADTR-H
hauteur
65mm /
altezza
65mm



ADTR-H 76MM
hauteur
76mm /
altezza
76mm

TROIS COLORIS
DE CADRES
FINITIONS
PROFILES
TRE COLORI



NOIR
NERO



BLANC
BIANCO



ARGENT
ARGENTO

FINITION ESTHETIQUE
DESIGN ELEGANTE

SANS PIECE
DE JONCTION
PLASTIQUE
NESSUN
CONNETTORE
NECESSARIO

ANGLES 90°
PARFAITS
ANGOLAZIONE
E TENUTA
GARANTITE

Kanlux FACTORY

Confiez-nous
votre éclairage

Kanlux FACTORY

Lasciaci illuminare
i tuoi progetti





Kanlux
FACTORY
CONFIGURATOR

Nous allons adapter la
lumière à vos besoins
**Lasciaci illuminare
i tuoi progetti**

CONFIGUREZ VOUS MEME VOTRE LUMINAIRE
CONFIGURATE DA SOLI LA LAMPADA PERFETTA



Kanlux **ALIN**



Kanlux **OFIS S**



Kanlux **HIERRO**



Kanlux **FUTURIO**

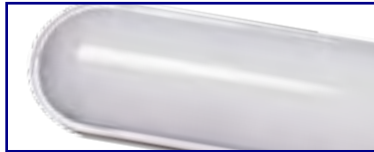

Kanlux **ADTR**



LONGUEUR
LUNGHEZZA

DIFFUSEUR
DIFFUSORE

TEMPERATURE DE COULEUR
TEMPERATURA KELVIN

PUISSANCE
POTENZA

COULEUR FINITION
COLORE

MONTAGE
MONTAGGIO

Configurateur pour
concevoir une
installation.

Crea il tuo prodotto in base
alle tue esigenze attraverso
l'utile configuratore.



Kanlux





SOURCES LUMINEUSES LIGHT SOURCES

Vous souhaitez des sources lumineuses saines et durables? Notre offre est hautement qualitative tant au niveau de la production qu'au niveau du contrôle assuré par notre laboratoire interne Kanlux. Kanlux vous propose des produits conformes aux normes de sécurité et qui répondront à vos exigences.

Desideri essere circondato da prodotti affidabili, e duraturi. Nel laboratorio Kanlux Ci prendiamo cura di tutti questi aspetti. Siamo certi di fornirti prodotti completamente sicuri che incontrino le tue esigenze.



*Les données photométriques et plugin
Dialux sont téléchargeables sur :*

dati fotometrici sono disponibili su:

► kanlux.com

KANLUX SMART

SOURCE LUMINEUSE LED ► LAMPADINA LED



S A60 7W E27 CCT



S A60 9W E27 RGB CCT



Une maison moderne est une maison intelligente et fonctionnelle. Les ampoules de la gamme Kanlux SMART sont conçues de manière à permettre la transformation de chaque maison en une maison moderne. Vous pouvez les contrôler via une application mobile, le Wi-Fi ou le Bluetooth. Les ampoules Kanlux SMART disposent des fonctions suivantes: gradation, changement progressif de la couleur de la lumière (CCT) et de la couleur (RGB), que vous pouvez choisir parmi une palette de 16 millions de couleurs. Avec des fonctions telles que les horaires, le biorhythme et le couplage avec d'autres appareils SMART, vous pouvez adapter avec succès la lumière de votre maison à votre style de vie. Pour un confort d'utilisation encore plus grand, vous pouvez contrôler les ampoules SMART Kanlux par commande vocale (Google Assistant/Alexa). En savoir plus sur www.kanluxsmart.com

Una casa moderna è una casa intelligente e funzionale. La famiglia di lampadine Kanlux SMART è progettata in modo tale da consentire la trasformazione di ogni casa in una abitazione moderna. Puoi controllarle tramite un'app mobile, tramite Wi-Fi o Bluetooth. Le lampadine Kanlux SMART hanno le seguenti funzioni: dimmer, cambio graduale del colore della luce (CCT) e colore (RGB), che puoi scegliere da una tavolozza di 16 milioni di colori. Con funzionalità come gli orari, bioritmo e raggruppamento con altri dispositivi SMART, puoi regolare la luce nella tua casa adattandola al tuo stile di vita. Per un comfort di utilizzo ancora maggiore, puoi controllare le lampadine Kanlux SMART tramite comando vocale (Assistente Google/Alexa). Scopri di più su www.kanluxsmart.com



S A60 7W E27 CCT	33640	5905339336408	7	60	806	2700-6500	320	E27	E
S A60 9W E27 RGB CCT	33641	5905339336415	9	60	806	2700-6500	180	E27	F
S A60 11,5W E27 RGB CCT	33642	5905339336422	11,5	75	1055	2700-6500	180	E27	F
S GU10 4,7W RGB CCT	33643	5905339336439	4,7	39	325	2700-6500	110	GU10	G
S C37 4,9W E14 RGB CCT	33644	5905339336446	4,9	40	470	2700-6500	180	E14	F



Contrôlez les produits Kanlux SMART avec l'application mobile SMART LIFE

Controlla i prodotti Kanlux Smart attraverso l'applicazione SMART LIFE

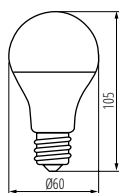

S A60 7W E27 CCT

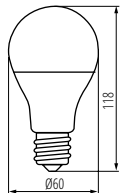

S A60 9W E27 RGB CCT

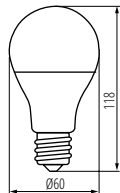

S A60 11,5W E27 RGB CCT

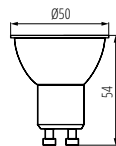

S GU10 4,7W RGB CCT

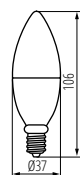

S C37 4,9W E14 RGB CCT

Kanlux

KANLUX SMART

SOURCE LUMINEUSE LED ► LAMPADINA LED



S A60 7W E27 CCT



S A60 9W E27 RGB CCT



S A60 11,5WE27 RGB CCT



S GU10 4,7W RGB CCT



S C37 4,9W E14 RGB CCT



Vous pourrez contrôler l'éclairage de votre foyer en utilisant la voix. Les sources Kanlux SMART sont compatibles avec Amazon Alexa et Google Home.

Puoi controllare l'illuminazione di casa usando la tua voce. Le lampade Kanlux SMART utilizzano Amazon Alexa e Google Home.

Fonction Biorythme | Funzione „Bioritmo”

Fonction Programmation horaire | Funzione „Risveglio”

Fonction Compte à rebours | Funzione „Conto alla rovescia”

Fonction de liaison intelligente différentes applications/Tap-to-Run | Funzione „Automazione/tap to run”

Programmation Scènes | Funzione „Scenario”

Sources Kanlux SMART contrôlées par Wi-Fi et Bluetooth 2,4Ghz

Le lampadine Kanlux SMART vengono controllate grazie al Wi-Fi 2,4 GHz e Bluetooth

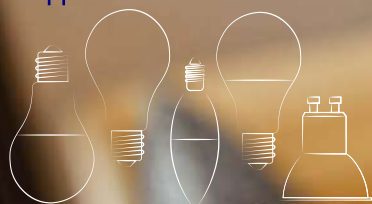

www.kanluxsmart.com

Kanlux IQ-LED LIFE

SOURCE LUMINEUSE LED ► LAMPADINA LED



IQ-LED L G45 4,2W



IQ-LED L GU10 4,8W



Kanlux IQ-LED LIFE offre une sécurité photobiologique exceptionnelle, une température de couleur agréable à l'œil et une grande fiabilité. Les nouveaux modèles LIFE de la série bien connue IQ-LED sont dépourvus de lumière bleue donc plus proches de la lumière naturelle et extrêmement sûrs et respectueux de vos yeux et de ceux de vos proches. Les lampes Kanlux IQ-LED LIFE offrent un grand confort d'utilisation et un très bon rendu des couleurs naturelles (RA90) ainsi qu'une garantie de cinq ans.

Une garantie de 5 ans accordée conformément aux termes de la déclaration de garantie disponible sur le site d'Internet

Matériau du diffuseur: matériau plastique

Kanlux IQ-LED LIFE è indice di sicurezza fotobiologica e di una temperatura di colore amica dei tuoi occhi. I nuovi modelli LIFE della nota serie Kanlux IQ-LED si caratterizzano per minor luce blu, grazie a questa caratteristica Kanlux IQ-LED LIFE emette una luce il più possibile naturale, è estremamente sicura ed affidabile. Le lampadine Kanlux IQ-LED LIFE offrono il massimo comfort di utilizzo e un'elevata valorizzazione dei colori naturali (RA90), oltre a una garanzia di cinque anni.

5 anni di garanzia secondo le condizioni della dichiarazione di garanzia consultabile sul sito Internet

Diffusore: plastica



Model	Code	Power [W]	Beam Angle [°]	Lumens [lm]	Color Temp [K]	Beam Angle [°]	Base	Energy Class	
IQ-LED L G45 4,2W-WW	33760	5905339337603	4,2	40	470	2700	240	E14	E
IQ-LED L G45 4,2W-NW	33761	5905339337610	4,2	41	490	4000	240	E14	E
IQ-LED L A60 7,2W-WW	33762	5905339337627	7,2	60	806	2700	220	E27	E
IQ-LED L A60 7,2W-NW	33763	5905339337634	7,2	62	840	4000	220	E27	E
IQ-LED L GU10 4,8W-WW	33764	5905339337641	4,8	49	450	2700	100	GU10	E
IQ-LED L GU10 4,8W-NW	33765	5905339337658	4,8	49	450	4000	100	GU10	E

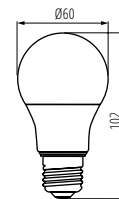

IQ-LED L A60 7,2W

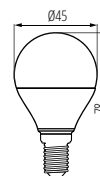

IQ-LED L G45 4,2W

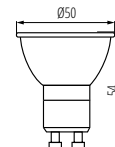

IQ-LED L GU10 4,8W

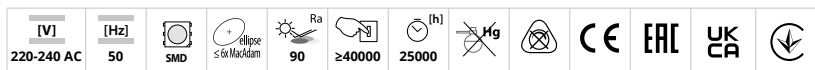

Kanlux

IQ-LED LIFE

SOURCE LUMINEUSE LED ► LAMPADINA LED



IQ-LED L G45 4,2W



IQ-LED L A60 7,2W



IQ-LED L GU10 4,8W

KANLUX vous offre une NOUVELLE QUALITÉ DE LUMIÈRE!

Kanlux sta RIVOLUZIONANDO il mercato e ti offre una NUOVA QUALITÀ DELLA LUCE!



Kanlux

IQ-LED A60

SOURCE LUMINEUSE LED ► LAMPADINA LED

NEW



IQ-LED A60 3,4W



IQ-LED A60 5,9W



IQ-LED A60 7,8W



IQ-LED A60 11W

			Power (W)	Beam angle (°)	Light output (lm)	Color temperature (K)	Beam diameter (mm)	Base (E27)	Energy efficiency class (Ei)
IQ-LED A60 3,4W-WW	36670	5905339366702	3,4	40	470	2700	180	E27	D
IQ-LED A60 3,4W-NW	36671	5905339366719	3,4	40	470	4000	180	E27	D
IQ-LED A60 3,4W-CW	36672	5905339366726	3,4	40	470	6500	180	E27	D
IQ-LED A60 5,9W-WW	36673	5905339366733	5,9	60	806	2700	180	E27	D
IQ-LED A60 5,9W-NW	36674	5905339366740	5,9	60	806	4000	180	E27	D
IQ-LED A60 5,9W-CW	36675	5905339366757	5,9	60	806	6500	180	E27	D
IQ-LED A60 7,8W-WW	36676	5905339366764	7,8	75	1055	2700	180	E27	D
IQ-LED A60 7,8W-NW	36677	5905339366771	7,8	75	1055	4000	180	E27	D
IQ-LED A60 7,8W-CW	36678	5905339366788	7,8	75	1055	6500	180	E27	D
IQ-LED A60 11W-WW	36679	5905339366795	11	100	1521	2700	180	E27	D
IQ-LED A60 11W-NW	36680	5905339366801	11	100	1521	4000	180	E27	D
IQ-LED A60 11W-CW	36681	5905339366818	11	100	1521	6500	180	E27	D

[V] 220-240 AC
[Hz] 50
SMD
360° Use
±15% ellipse
Ra ≥90
≥50000
25000 (h)
Hg
RoHS
CE
ERC
UK
Recycle

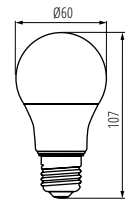

IQ-LED A60 3,4W

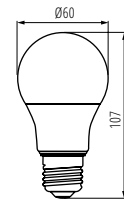

IQ-LED A60 5,9W

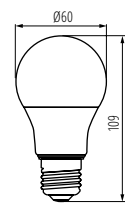

IQ-LED A60 7,8W

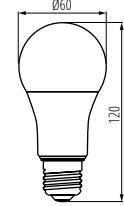

IQ-LED A60 11W

3+ WARRANTY 3 years
SAFE light
Ra90+ true colors
QUALITY & COMFORT of light

Kanlux IQ-LED A60 c'est une température de couleur agréable pour les yeux et la fiabilité, tout en conservant le design classique de l'ampoule A60. Les nouvelles ampoules IQ-LED Kanlux garantissent une efficacité lumineuse exceptionnelle, jusqu'à 138 lumens par watt et une consommation d'énergie réduite. Les ampoules IQ-LED Kanlux offrent un confort d'utilisation et une sécurité totale.

Matériau: matériau plastique

Matériau du diffuseur: matériau plastique

Kanlux IQ-LED A60 è garanzia di affidabilità e sicurezza per la tua vista. Il tutto nel classico design di una lampadina dalla forma A60. Le nuove lampadine IQ-LED di Kanlux offrono anche eccezionale efficacia luminosa, fino a 138 Lumen per Watt, e di conseguenza minore consumo energetico.

Materiale: plastica

Diffusore: plastica



Kanlux

IQ-LED A67

SOURCE LUMINEUSE LED ► LAMPADINA LED



IQ-LED A67 N 19W-WW



IQ-LED A67 N 19W-NW



IQ-LED A67 N 19W-CW

3
WARRANTY
3 years

SUPER
HIGH
lumen

SAFE
light

QUALITY & COMFORT
of light

Kanlux IQ-LED est une garantie de sécurité photobiologique, de température de couleur agréable à l'oeil et de fiabilité. Maintenant tout cela dans une nouvelle ampoule de grand taille A67.

Matériau: matériau plastique

Matériau du diffuseur: matériau plastique

Kanlux IQ-LED significa sicurezza fotobiologica, temperatura di colore sicura per i nostri occhi e affidabilità, il tutto abbinato ad un design di una classica lampadina A60. Le lampadine IQ-LED garantiscono un confort accreditato dalla certificazione indipendente TÜV Rheinland.

Materiale: plastica

Diffusore: plastica

IQ-LED A67 N 19W-WW	33746	5905339337467	19	150	2452	2700	200	E27 E
IQ-LED A67 N 19W-NW	33747	5905339337474	19	150	2452	4000	200	E27 E
IQ-LED A67 N 19W-CW	33748	5905339337481	19	150	2452	6500	200	E27 E

[V]
220-240 AC

[Hz]
50

SMD

360°
Φ_{use}

Flippse
≤ 6% Nachstrahl

Ra
80

[h]
≥40000

15000

Hg

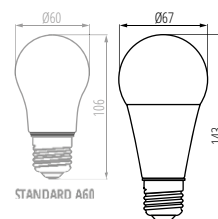

IQ-LED A67 N 19W

Kanlux

IQ-LEDDIM A60

SOURCE LUMINEUSE LED ► LAMPADINA LED



IQ-LEDDIM A60 7,3W



IQ-LEDDIM A60 10,5W



IQ-LEDDIM A60 13,6W



Kanlux IQ-LED est une garantie de sécurité photobiologique, de température de couleur agréable à l'œil et de fiabilité. Maintenant tout cela dans une nouvelle version avec culot GU10 - en plus la version IQ-LEDIM fonctionne avec des gradateurs. Les ampoules IQ-LED offrent un confort et une sécurité totale pour l'utilisateur, comme le confirme la certification TÜV Rheinland.

Matériau: matériau plastique

Matériau du diffuseur: matériau plastique

Kanlux IQ-LED significa sicurezza fotobiologica, temperatura di colore sicura per i nostri occhi e affidabilità, il tutto abbinato ad una nuova versione di prodotto con l'attacco E27. Inoltre la versione IQ-LEDDIM è dimmerabile.

Materiale: plastica

Diffusore: plastica

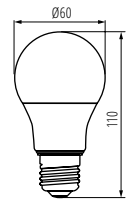

IQ-LEDDIM A60 7,3W; IQ-LEDDIM A60 10,5W

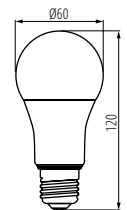

IQ-LEDDIM A60 13,6W

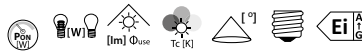

Code	Part Number	Power (W)	Power Factor	Beam Angle (°)	Color Temp (K)	Life (h)	Temp (°C)	Base	Dimmable
IQ-LEDDIM A60 7,3W-WW	33722	5905339337221	7,3	60	806	2700	220	E27	E
IQ-LEDDIM A60 7,3W-NW	33723	5905339337238	7,3	60	806	4000	220	E27	E
IQ-LEDDIM A60 10,5W-WW	33724	5905339337245	10,5	75	1060	2700	220	E27	F
IQ-LEDDIM A60 10,5W-NW	33725	5905339337252	10,5	75	1060	4000	220	E27	F
IQ-LEDDIM A60 13,6W-WW	33726	5905339337269	13,6	100	1521	2700	220	E27	E
IQ-LEDDIM A60 13,6W-NW	33727	5905339337276	13,6	100	1521	4000	220	E27	E



Kanlux

XLED EX A60

SOURCE LUMINEUSE LED ► LAMPADINA LED

NEW



XLED EX A60 4W



XLED EX A60 5W



XLED EX A60 7,2W



La nouvelle version des sources lumineuses EXTRÊMEMENT efficaces Kanlux XLED EX A60 v2. Avec une efficacité lumineuse supérieure à la moyenne de 210 lumens par watt, ces ampoules LED sont 15 fois plus efficaces que leurs prédécesseurs traditionnels. Une garantie de 5 ans, une durée de vie de 50.000 heures et 50.000 cycles d'allumage et d'extinction sont d'autres atouts. De plus, elles sont en verre et des „tiges” de filament qui les rendent visuellement similaires aux ampoules traditionnelles mais avec les dernières avancées de la technologie LED.

Une garantie de 5 ans accordée conformément aux termes de la déclaration de garantie disponible sur le site d'Internet

Matériau du diffuseur: verre

La nuova versione delle lampade Kanlux XLED EX A60 v2 è ora disponibile. L'eccezionale efficienza luminosa pari a 210 lumen per watt rende queste lampadine LED 15 volte più efficienti delle loro predecessori tradizionali. Cinque anni di garanzia, 50.000 ore di durata e 50.000 cicli di accensione/spegnimento sono altri vantaggi. Inoltre, hanno un involucro di vetro e filamenti a led che le rendono simili alle lampadine al tungsteno, ma sfruttano le ultime tecnologie LED.

5 anni di garanzia secondo le condizioni della dichiarazione di garanzia consultabile sul sito Internet

Diffusore: vetro



XLED EX A60 4W-WW	36243	5905339362438	4	62	840	2700	320	E27	A
XLED EX A60 4W-NW	36244	5905339362445	4	62	840	4000	320	E27	A
XLED EX A60 5W-WW	36245	5905339362452	5	75	1055	2700	320	E27	A
XLED EX A60 5W-NW	36246	5905339362469	5	75	1055	4000	320	E27	A
XLED EX A60 7,2W-WW	36247	5905339362476	7,2	100	1521	2700	320	E27	A
XLED EX A60 7,2W-NW	36248	5905339362483	7,2	100	1521	4000	320	E27	A

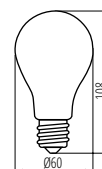

XLED EX A60



XLED A60

SOURCE LUMINEUSE LED ► LAMPADINA LED



XLED A60 4,5W



XLED A60 7W



XLED A60 8W; 10W



Kanlux XLED combine les meilleures qualités des ampoules traditionnelles et des sources lumineuses LED modernes. C'est pourquoi nous l'appelons la première vraie ampoule LED. La bulbe en verre est de la forme d'une ampoule traditionnelle et les diodes LED sont placées de manière à permettre à la lumière de se propager dans toutes les directions. L'angle de faisceau peut atteindre même 320 degrés !

Matériau du diffuseur: verre

Kanlux XLED combina le migliori caratteristiche delle lampade tradizionali con le più moderne lampadine led. Siamo soliti riferirci a questo tipo di lampada come la prima vera lampada LED. Realizzata in vetro ha un angolo di rifrazione della luce pari a 320°!

Diffusore: vetro



	[W]	[V]	[Hz]	[lm]	Φ _{use} [mm]	T _c [K]	[°]	[h]	[Ei]
XLED A60 4,5W-WW	29600	5905339296009	4,5	40	470	2700	320	E27	15000 F
XLED A60 7W-WW	29601	5905339296016	7	60	810	2700	320	E27	15000 E
XLED A60 7W-NW	29602	5905339296023	7	60	810	4000	320	E27	15000 E
XLED A60 7W-CW	29603	5905339296030	7	60	810	6500	320	E27	15000 E
XLED A60 8W-WW	29604	5905339296047	8	75	1055	2700	320	E27	15000 E
XLED A60 10W-WW	29605	5905339296054	10	99	1520	2700	320	E27	10000 D
XLED A60 10W-NW	29606	5905339296061	10	99	1520	4000	320	E27	10000 D



XLED A60 4,5W; XLED A60 7W; XLED A60 8W; XLED A60 10W

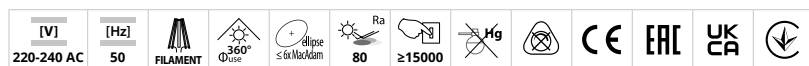

Kanlux

XLED A70

SOURCE LUMINEUSE LED ► LAMPADINA LED



XLED A70 18W



SUPER HIGH
lumen

320°

NEW GENERATION
bulb

Kanlux XLED combine les meilleures caractéristiques des ampoules traditionnelles et des sources de lumière modernes à LED. C'est pourquoi on l'appelle « la première véritable ampoule LED ». L'ampoule de verre A70 a une forme d'une ampoule traditionnelle d'une taille supérieure à la moyenne, et les LED sont disposées à l'intérieur de telle sorte que la lumière est distribuée dans toutes les directions.

Matériau du diffuseur: verre

Kanlux XLED combina le migliori caratteristiche delle lampade tradizionali con le più moderne lampadine led. Il bulbo A70 combinato alla disposizione di questi diodi LED permette alla luce di diffondersi uniformemente in tutte le direzioni.

Diffusore: vetro



XLED A70 18W-WW	29648	5905339296481	18	149	2450	2700	320	E27	D
XLED A70 18W-NW	29649	5905339296498	18	149	2450	4000	320	E27	D

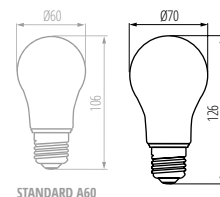
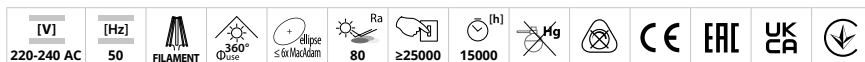

XLED A70 18W

Kanlux

XLED STEPDIM

SOURCE LUMINEUSE LED ► LAMPADINA LED



XLED A60 7W-STEPDIM



XLEDA60 7W-WW-STEPDIM	29634	5905339296344	max 7	60	max 810	2700	320	E27	E
XLEDA60 7W-NW-STEPDIM	29635	5905339296351	max 7	60	max 810	4000	320	E27	E

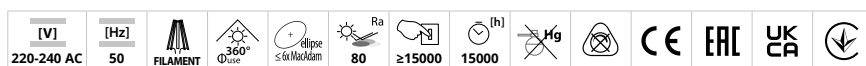

STEP DIMMING function

- 1x CLICK 100% power
- 2x CLICK 50% power
- 3x CLICK 7% power
- 2x CLICK + RESET 100% power
- <0,5s



Kanlux XLED combine les meilleures qualités des ampoules traditionnelles et des sources lumineuses LED modernes. C'est pourquoi nous l'appelons la première vraie ampoule LED. La bulbe en verre est de la forme d'une ampoule traditionnelle et les diodes LED sont placées de manière à permettre à la lumière de se propager dans toutes les directions. De plus, la variante STEP DIM offre la possibilité de diminuer progressivement le flux lumineux sans un variateur supplémentaire.

Matériau du diffuseur: verre

Kanlux XLED col bulbo dalla forma tradizionale combinato alla disposizione dei diodi LED permette alla luce di diffondersi uniformemente in tutte le direzioni. In aggiunta il dimmer a STEP permette di incrementare o diminuire la luce senza ausilio di dimmer.

Diffusore: vetro

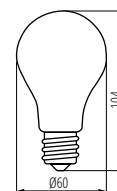

XLED A60 7W-STEPDIM

Kanlux

XLEDIM A60

SOURCE LUMINEUSE LED ► LAMPADINA LED

NEW



XLEDIM A60 E27 11W



XLEDIM A60 E27 11W-WW	37240	5905339372406	11	100	1521	2700	320	E27	D
XLEDIM A60 E27 11W-NW	37241	5905339372413	11	100	1521	4000	320	E27	D
XLEDIM A60 E27 11W-CW	37242	5905339372420	11	100	1521	6500	320	E27	D

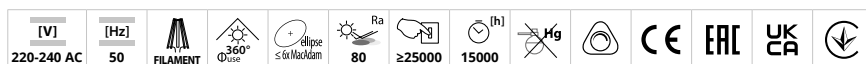

Kanlux XLEDIM A60 est une ampoule de forme traditionnelle à haut rendement lumineux. Kanlux XLEDIM A60 possède un filament décoratif qui sera du plus bel effet dans les lampes ouvertes. Les ampoules Kanlux XLEDIM A60 de 11W donnent une lumière équivalente aux ampoules à incandescence traditionnelles de 100W (1520lm) et fonctionnent avec des variateurs. En outre, elles offrent un confort d'utilisation et une sécurité totale, ce qui est confirmé par les tests effectués dans le laboratoire Kanlux.

Matériau du diffuseur: verre

Kanlux XLEDIM A60 ha una diffusione della luce ampia ed una forma tradizionale. Kanlux XLEDIM A60 è una lampada dotata di un filamento decorativo. Le Kanlux XLEDIM A60 11W forniscono luce equivalente a lampadine tradizionali da 100W (1520lm) e sono inoltre dimmerabili.

Diffusore: vetro

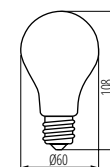

XLEDIM A60 E27 11W

Kanlux

XLED A60 B22

SOURCE LUMINEUSE LED ► LAMPADINA LED



XLED A60 B22



XLED A60M B22-M

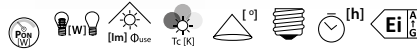

Model	Power (W)	Code	Power (W)	Beam Angle (°)	Beam Diameter (mm)	Temp (K)	Beam Diameter (mm)	Lifespan (h)	Energy Efficiency (E)	
XLED A60 B22 7W-WW	33100	5905339331007	7	60	810	2700	320	B22	15000	E
XLED A60 B22 7W-WW-M	33102	5905339331021	7	60	810	2700	320	B22	15000	E
XLED A60 B22 7W-CW-M	33103	5905339331038	7	60	810	6500	320	B22	15000	E
XLED A60 B22 10W-WW-M	33108	5905339331083	10	99	1520	2700	320	B22	10000	D
XLED A60 B22 10W-CW-M	33109	5905339331090	10	99	1520	6500	320	B22	10000	D

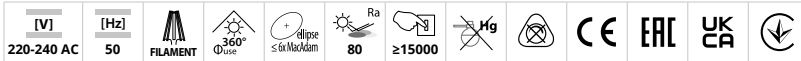

Kanlux XLED A60 B22 M combine les meilleures caractéristiques des ampoules traditionnelles et des sources lumineuses LED modernes. Ampoule opaque ayant la forme d'une ampoule traditionnelle et des diodes LED disposées de manière à ce que la lumière se diffuse dans toutes les directions et l'angle de rayonnement est même de 320°! XLED A60 B22 M ont un culot B22.

Matériau du diffuseur: verre

Kanlux XLED A60 B22 M combina le migliori caratteristiche delle lampade tradizionali con le più moderne lampadine LED. Il bulbo in vetro opaco, dalla forma classica, diffonde la luce dei led posti al suo interno con un angolo di rifrazione di 320°! Le lampadine XLED A60 B22 M hanno una attacco B22.

Diffusore: vetro

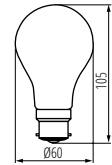

XLED A60 B22

Kanlux

XLEDIM A60 B22

SOURCE LUMINEUSE LED ► LAMPADINA LED



XLEDIM A60 B22 12W



Model	Power (W)	Code	Power (W)	Beam Angle (°)	Beam Diameter (mm)	Temp (K)	Beam Diameter (mm)	Lifespan (h)	Energy Efficiency (E)
XLEDIM A60 B22 12W-WW	37243	5905339372437	12	100	1521	2700	320	B22	E
XLEDIM A60 B22 12W-CW	37244	5905339372444	12	100	1521	6500	320	B22	E



Kanlux XLEDIM A60 est une ampoule de forme traditionnelle à haut rendement lumineux. Kanlux XLEDIM A60 possède un filament décoratif qui sera du plus bel effet dans les lampes ouvertes. Les ampoules Kanlux XLEDIM A60 de 12W donnent une lumière équivalente aux ampoules à incandescence traditionnelles de 100W (1520lm) et fonctionnent avec des variateurs. Les sources marquées du symbole B22 sont équipées du culot B22.

Matériau du diffuseur: verre

Kanlux XLEDIM A60 B22 ha una diffusione della luce ampia ed una forma tradizionale. Kanlux XLEDIM A60 è una lampada dotata di un filamento decorativo. Le Kanlux XLEDIM A60 11W forniscono luce equivalente a lampadine tradizionali da 100W (1520lm) e sono inoltre dimmerabili. Attacco B22..

Diffusore: vetro

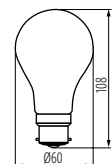

XLEDIM A60 B22 12W

Kanlux

RAPIDv2 LED

SOURCE LUMINEUSE LED ► LAMPADINA LED



RAPID v2 E27



RAPID PRO v2 E27



RAPID MAXX v2 E27



RAPID HI v2 E27



Les sources Kanlux RAPIDv2 E27 ont été fabriquées avec la plus grande attention à chaque détail. Elles se distinguent par un flux lumineux élevé et une efficacité lumineuse atteignant près de 117 lm/W (RAPID HI). Un autre avantage de ces lampes LED est a conception hybride du boîtier.

Matériau: matériau plastique

Matériau du diffuseur: matériau plastique

Kanlux RAPID E27 sono state realizzate con la massima attenzione ad ogni dettaglio. Le versioni Kanlux RAPID HI sono ad alta potenza luminosa (equivalente ai tradizionali lampadine di 100W). Si distinguono per alti parametri raggiungendo quasi 117 lm/W. Un ulteriore vantaggio di queste lampadine a LED è la costruzione ibrida del diffusore.

Materiale: plastica

Diffusore: plastica

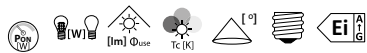

RAPID v2 E27-NW	22944	5905339229441	4,9	41	500	4000	180	E27	F
RAPID v2 E27-WW	22945	5905339229458	4,9	41	500	3000	180	E27	F
RAPID PRO v2 E27-NW	22946	5905339229465	8	60	810	4000	180	E27	F
RAPID PRO v2 E27-WW	22947	5905339229472	8	60	810	3000	180	E27	F
RAPID MAXX v2 E27-NW	22948	5905339229489	9,5	74	1050	4000	180	E27	E
RAPID MAXX v2 E27-WW	22949	5905339229496	9,5	74	1050	3000	180	E27	E
RAPID HI v2 E27-NW	22954	5905339229540	13	99	1520	4000	180	E27	E
RAPID HI v2 E27-WW	22955	5905339229557	13	99	1520	3000	180	E27	E

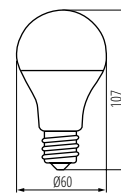

RAPID v2 E27; RAPID PRO v2 E27

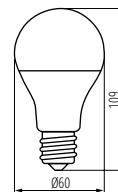

RAPID MAXX v2 E27

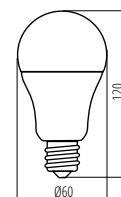

RAPID HI v2 E27

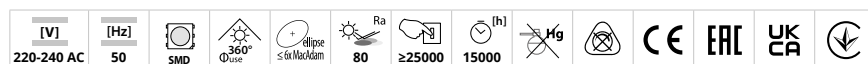

ST45 LED

SOURCE LUMINEUSE LED ► LAMPADINA LED



ST45 LED 0,5W



NEW

ST45 LED 0,9W E27-RE



NEW

ST45 LED 0,9W E27-GR



NEW

ST45 LED 0,9W E27-BL



Kanlux ST45 LED est une ampoule en plastique qui offre une résistance exceptionnelle à la casse dans des conditions extérieures. Elle constitue un excellent complément à une guirlande lumineuse, mais convient également aux luminaires de jardin tels que le Kanlux VIMO, par exemple, ainsi qu'à l'éclairage des vérandas, des terrasses, des kiosques de jardin ou des terrasses de restaurant. Les lampes LED ST45 ont un culot E27 et sont particulièrement économiques à l'usage. Elles sont disponibles en blanc chaud et en blanc neutre, ainsi que dans quelques couleurs sélectionnées (rouge, vert, bleu).

Matériau du diffuseur: matériau plastique

Kanlux ST45 LED è una lampadina in plastica ultrasensibile ed ideale per ambienti esterni. È un complemento perfetto per le cordoniere luminose, ma funzionerà anche in altri prodotti da giardino come i Kanlux VIMO. Ideale per illuminare verande, terrazze, gazebo e giardini. I LED ST45 hanno un attacco E27 e sono estremamente convenienti. Sono disponibili in bianco caldo e bianco neutro, nonché in diversi colori (rosso, verde, blu).

Diffusore: plastica

	PN	Φ _{use}	Φ _{base}	Φ _{filament}	Φ _{base}	Φ _{base}
ST45 LED 0,5W E27-WW	26045	5905339260451	0,5	50	blanc chaud Bianco caldo	220 E27
ST45 LED 0,5W E27-NW	26046	5905339260468	0,5	50	blanche bianco	220 E27
ST45 LED 0,9W E27-BL	26039	5905339260390	0,9	8	bleue azzurra	220 E27
ST45 LED 0,9W E27-GR	26048	5905339260482	0,9	75	verte verde	220 E27
ST45 LED 0,9W E27-RE	26049	5905339260499	0,9	20	rouge rossa	220 E27

[V] 220-240 AC
[Hz] 50
FILAMENT
360° Φ_{use}
≥15000
15000
Hg
IK 04
CE
ERC
UKA
↓

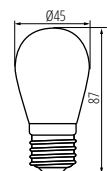

ST45 LED E27

Kanlux

ST64 A

SOURCE LUMINEUSE LED ► LAMPADINA LED



ST64 A 4W-SW



ST64 A 4W-SW	26047	5905339260475	4	20	200	1800	E27
--------------	--------------	---------------	---	----	-----	------	-----

[V]	[Hz]	FILAMENT	360° Øuse	Ra	≥15000	25000	[h]	Hg	CE	EAC	UK CA	↓
220-240 AC	50			80								



DECO RI function

1800K SUPER WARM

unique LIGHT effect

Kanlux ST64 A est une ampoule LED particulièrement décorative avec une couleur de lumière très chaude (1800K). Le „filament LED” et le verre ambré, mais aussi l’anneau au niveau du culot de cette source lumineuse sont très décoratifs.

Matériau du diffuseur: verre

Kanlux ST64 A è una lampadina LED eccezionalmente decorativa con un colore della luce extra caldo (1800K). Il „filamento LED” ed il vetro ambrato la rendono davvero unica dal punto di vista del design. Ideale per creare un’atmosfera calda favorevole al relax.

Diffusore: vetro



ST64 A 4W-SW

Kanlux

XLED ST64

SOURCE LUMINEUSE LED ► LAMPADINA LED



XLED ST64-7W



XLED ST64C 7W



XLED ST64 7W-WW	29637	5905339296375	7	55	725	2700	320	E27	F
XLED ST64C 7W-NW	33513	5905339335135	7	60	806	4000	320	E27	E

[V]	[Hz]	FILAMENT	360° Øuse	ellipse ≤(6x)Nachdam	Ra	≥15000	15000	[h]	Hg	CE	EAC	UK CA	↓
220-240 AC	50			80									



320°

HIGH lumen

FILAMENT LED

Kanlux XLED combine les meilleures qualités des ampoules traditionnelles et des sources lumineuses LED modernes. C’est pourquoi nous l’appelons la première vraie ampoule LED. La bulbe en verre et les diodes LED sont placées de manière à permettre à la lumière de se propager dans toutes les directions. De plus, la variante ST64 est fabriquée en verre de couleur dorée, ce qui souligne la tonalité chaude de la lumière de cette source et lui confère une touche d’élégance supplémentaire.

Matériau du diffuseur: verre

Kanlux XLED ST64 combina le migliori caratteristiche delle lampade tradizionali con le più moderne lampadine LED. Inoltre siamo soliti riferirci a questo tipo di lampada come la prima vera lampada LED. La versione ST64 è realizzata in vetro color oro che enfatizza il colore caldo della luce conferendole una “nobile” eleganza e ora anche in vetro colore trasparente.

Diffusore: vetro

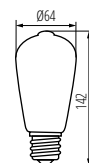

XLED ST64 7W

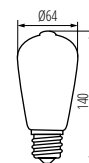

XLED ST64C 7W

Kanlux

XLED A60 MIRROR

SOURCE LUMINEUSE LED ► LAMPADINA LED



XLED A60 M 7W



Les ampoules très décoratives Kanlux XLED MIRROR fournissent une lumière argentée. Une partie de la sphère est constituée d'un miroir qui s'intègre parfaitement aux designs modernes. La lumière de Kanlux XLED MIRROR est réfléchié vers le haut par une couche réfléchissante, ce qui réduit la lumière directe et crée une atmosphère chaleureuse. Elle est parfaite pour les luminaires avec ampoule apparente ou pour les lampes avec abat-jour, où l'on peut obtenir un effet d'une lumière tamisée et romantique.

Matériau: verre

Caratteristica distintiva delle Kanlux XLED MIRROR è la calotta cromata. Questa caratteristica non è solo esteticamente pregevole ma permetterà di evitare un abbagliamento diretto. Ideale per lampade dotate di paralume creerà un'atmosfera soffusa. Parte della lampadina è rivestita a specchio.

Materiale: vetro



XLED A60 M 7W-WW	33514	5905339335142	7	52	680	2700	150	E27	F
XLED A60 M 7W-NW	33515	5905339335159	7	52	680	4000	150	E27	F

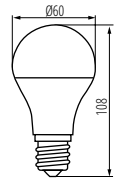

XLED A60 M 7W

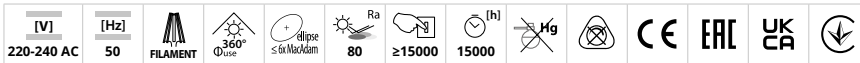

Kanlux

XLED G95

SOURCE LUMINEUSE LED ► LAMPADINA LED



XLED G95 7W-WW



XLED G95 5,8W-NW



Kanlux XLED c'est ne sont pas seulement les meilleures performances lumineuses, mais aussi esthétiques. Les ampoules XLED G95 c'est une grande bulle de verre ronde avec un grand angle de diffusion. Kanlux XLED G95 est très impressionnant dans les lampes ouvertes et les appliques, ainsi que dans les suspensions sans abat-jour. Le modèle XLED G95S avec verre fumé foncé, une source de lumière extrêmement décorative mais aussi très élégante, est particulièrement remarquable.

Matériau du diffuseur: verre

Kanlux XLED è garanzia dei migliori parametri illuminotecnici, ma anche estetici. Le lampadine Kanlux XLED G95 sono grandi e rotonde e garantiscono un ampio angolo di rifrazione della luce. Kanlux XLED G95 è sinonimo di efficienza luminosa abbinata a caratteristiche estetiche e decorative inconfondibili. Il modello XLED G95S ha vetro scuro fumé, è una fonte di luce estremamente rilassante ed elegante.

Diffusore: vetro



XLED G95 7W-WW	36241	5905339362414	7	55	725	2500	320	E27	F
XLED G95 5,8W-NW	36242	5905339362421	5,8	40	470	4000	320	E27	G

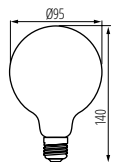

XLED G95

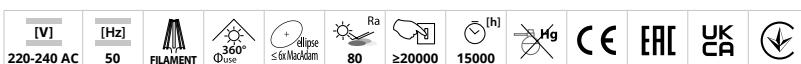

Kanlux XLED G125

SOURCE LUMINEUSE LED ► LAMPADINA LED



XLED G125 7W



XLED G125 7W-WW | 29638 | 5905339296382 | 7 | 55 | 725 | 2700 | 320 | E27 | F

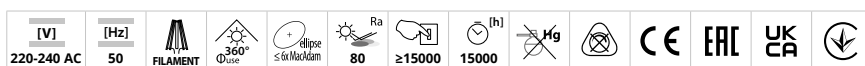

Kanlux X LED offre non seulement les meilleurs paramètres d'éclairage, mais aussi des qualités décoratives. Les ampoules Kanlux X LED G125 possèdent une grande bulbe sphérique en verre et un angle de faisceau large. Kanlux X LED G125 sont particulièrement impressionnantes dans les lampes ouvertes et les appliques murales, ainsi que dans des appliques sans abat-jour.

Matériau du diffuseur: verre

Kanlux XLED è sinonimo non solo di migliori parametri d'illuminazione, ma anche di una maggiore decoratività. Le lampadine Kanlux XLED G125 si distinguono per un grande bulbo tondo in vetro e l'ampio angolo d'illuminazione. Kanlux XLED G125 hanno un look molto piacevole soprattutto in abbinamento con le lampade soprattutto se abbinate a lampade a sospensione senza paralumi.

Diffusore: vetro

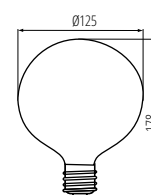

XLED G125 7W

Kanlux XLED G125

SOURCE LUMINEUSE LED ► LAMPADINA LED



XLED G125 11W



XLED G125 11W-WW | 33511 | 5905339335111 | 11 | 99 | 1520 | 2700 | 320 | E27 | D
XLED G125 11W-NW | 33512 | 5905339335128 | 11 | 99 | 1520 | 4000 | 320 | E27 | D

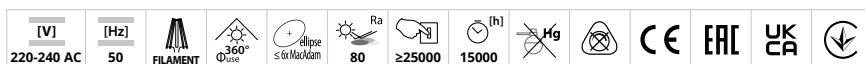

Kanlux XLED GLOBE sont de grandes sources lumineuses à caractère décoratif. Elles sont parfaites pour les luminaires ouverts ou les suspensions sans abat-jour. Les sources XLED GLOBE ont une efficacité lumineuse très élevée et un grand angle d'éclairage (320 degrés), elles peuvent donc éclairer efficacement la pièce.

Matériau du diffuseur: verre

Kanlux XLED GLOBE sono sorgenti luminose dal grande formato e dal carattere decorativo. Hanno un bell'aspetto. Le lampade Kanlux XLED GLOBE hanno un'efficienza luminosa molto elevata e un ampio angolo di rifrazione (320°), quindi possono illuminare efficacemente una stanza individualmente.

Diffusore: vetro

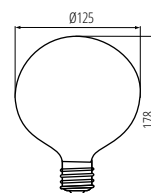

XLED G125 11W

Kanlux XLED SW

SOURCE LUMINEUSE LED ► LAMPADINA LED



XLED A60 4W-SW



XLED C35T 2,5W-SW



XLED ST64 4W-SW



XLED G95 4W-SW



XLED G125 4W-SW



**1800K
SUPER
WARM**



**DE
CORI
function**

Kanlux X LED offre non seulement les meilleurs paramètres d'éclairage, mais aussi des qualités décoratives. Les ampoules Kanlux X LED G125 possèdent une grande bulbe sphérique en verre et un angle de faisceau large. Kanlux X LED G125 sont particulièrement impressionnantes dans les lampes ouvertes et les appliques murales, ainsi que dans des appliques sans abat-jour.

Matériau du diffuseur: verre



Kanlux XLED è sinonimo non solo di migliori parametri d'illuminazione, ma anche di una maggiore decoratività. Le lampadine Kanlux XLED G125 si distinguono per un grande bulbo tondo in vetro e l'ampio angolo d'illuminazione. Kanlux XLED G125 hanno un look molto piacevole soprattutto in abbinamento con le lampade soprattutto se abbinate a lampade a sospensione senza paralumi.

Diffusore: vetro



Model	Code	Part No.	W	lm	lm/use	lm	lm	lm	lm	lm	lm
XLED C35T 2,5W-SW	29641	5905339296412	2,5	15	135	1800	320	≥15000	E14		
XLED A60 4W-SW	33516	5905339335166	4	25	250	1800	320	≥20000	E27		
XLED ST64 4W-SW	33517	5905339335173	4	25	250	1800	320	≥25000	E27		
XLED G95 4W-SW	33518	5905339335180	4	25	250	1800	320	≥20000	E27		
XLED G125 4W-SW	33519	5905339335197	4	25	250	1800	320	≥20000	E27		

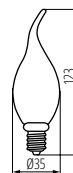

XLED C35T 2,5W-SW

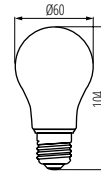

XLED A60 4W-SW



XLED ST64 4W-SW



XLED G95 4W-SW

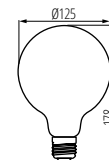

XLED G125 4W-SW

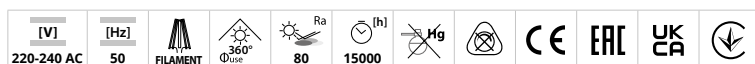

Kanlux

XLED W

SOURCE LUMINEUSE LED ► LAMPADINA LED

NEW



XLED W A60 8,5W-WW



XLED W ST64 7W-WW



XLED W C35E14 4,5W-WW



XLED W G45E14 4,5W-WW



WHITE
LED
FILA
MENT

DE
CO
RI
function

320

Les ampoules en verre Kanlux XLED W ont une forme et un style classiques tout en incorporant un filament blanc discret, ce qui est une nouveauté. Ce que vous gagnez, c'est l'efficacité énergétique des LED, mais les filaments jaunes ont été remplacés par des filaments blancs. La XLED W minimaliste est remarquablement décorative aussi en mode éteint. Le filament blanc unique produit une température de couleur chaude de 2700K. Kanlux XLED W est disponible dans formes populaires: traditionnelle, boule, bougie et ST64.

Matériau du diffuseur: verre

Le lampadine in vetro Kanlux XLED W hanno una forma e uno stile classico abbinato ad un filamento di colore tenue e neutro. In questo modo si otterrà un effetto minimalista. Il filamento bianco produce una luce calda di 2700K. Kanlux XLED W è disponibile nelle popolari forme a palla, candela e ST64.

Diffusore: vetro



XLED W A60 8,5W-WW



XLED W ST64 7W-WW

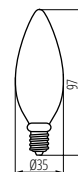

XLED W C35E14 4,5W-WW

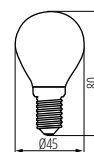

XLED W G45E14 4,5W-WW

	[V]	[Hz]	FILAMENT	360° O _{use}	360° O _{use}	80 Ra	≥20000 [h]	15000 [h]	Hg	RoHS	CE	EAC	UK CA	↓
XLED W A60 8,5W-WW	37380	5905339373809	8,5	75	1055	2700	320	E27	E					
XLED W ST64 7W-WW	37381	5905339373816	7	60	806	2700	320	E27	E					
XLED W C35E14 4,5W-WW	37382	5905339373823	4,5	40	470	2700	320	E14	F					
XLED W G45E14 4,5W-WW	37383	5905339373830	4,5	40	470	2700	320	E14	F					

[V]	[Hz]	FILAMENT	360° O _{use}	360° O _{use}	80 Ra	≥20000 [h]	15000 [h]	Hg	RoHS	CE	EAC	UK CA	↓
220-240 AC	50	FILAMENT	360° O _{use}	360° O _{use}	80 Ra	≥20000 [h]	15000 [h]	Hg	RoHS	CE	EAC	UK CA	↓

Kanlux

IQ-LED C35

SOURCE LUMINEUSE LED ► LAMPADINA LED

NEW



IQ-LED C35E14 3,4W



IQ-LED C35E14 3,4W



IQ-LED C35E14 5,9W



Kanlux IQ-LED A35 E14 c'est une température de couleur agréable pour les yeux et la fiabilité, tout en conservant le design classique d'une flamme. Les nouvelles ampoules IQ-LED Kanlux garantissent une efficacité lumineuse exceptionnelle, jusqu'à 138 lumens par watt et une consommation d'énergie réduite. Les ampoules IQ-LED Kanlux offrent un confort d'utilisation et une sécurité totale.

Matériau: matériau plastique

Matériau du diffuseur: matériau plastique

Kanlux IQ-LED A35 E14 sono lampade amiche dei nostri occhi. Sono sicure ed affidabili ed hanno la tradizionale forma a candela. Le nuove lampadine IQ-LED di Kanlux offrono anche eccezionale efficacia luminosa, fino a 138 Lumen per Watt, e di conseguenza minore dispendio energetico a parità di prestazioni.

Materiale: plastica

Diffusore: plastica



Model	Code	Part No.	Power (W)	Voltage (V)	Frequency (Hz)	Illuminance (lm)	Beam angle (°)	Temperature (K)	Lifetime (h)	Energy Efficiency (Ei)
IQ-LED C35E14 3,4W-WW	36682	5905339366825	3,4	40	470	2700	240	E14	D	
IQ-LED C35E14 3,4W-NW	36683	5905339366832	3,4	40	470	4000	240	E14	D	
IQ-LED C35E14 3,4W-CW	36684	5905339366849	3,4	40	470	6500	240	E14	D	
IQ-LED C35E14 5,9W-WW	36685	5905339366856	5,9	60	806	2700	240	E14	D	
IQ-LED C35E14 5,9W-NW	36686	5905339366863	5,9	60	806	4000	240	E14	D	
IQ-LED C35E14 5,9W-CW	36687	5905339366870	5,9	60	806	6500	240	E14	D	

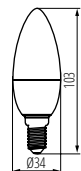

IQ-LED C35E14

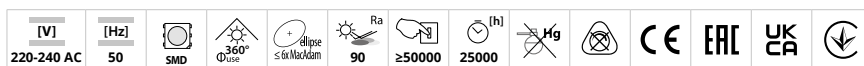

Kanlux XLEDEX C35

SOURCE LUMINEUSE LED ► LAMPADINA LED

NEW



XLEDEX C35E14 3,8W



XLEDEX C35E14 3,8W-WW	37340	5905339373403	3,8	60	806	2700	320	E14	A
XLEDEX C35E14 3,8W-NW	37341	5905339373410	3,8	60	806	4000	320	E14	A

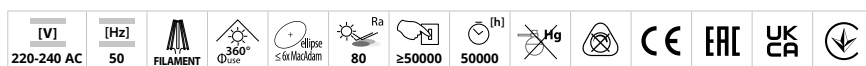

Les sources lumineuses EXTRÊMEMENT efficaces Kanlux XLED EX C35 3,8W sont équivalentes à des ampoules à incandescence de 60W. L'efficacité lumineuse supérieure à la moyenne (210 lumens par watt) rend ces sources lumineuses 15 fois plus efficaces que leurs prédécesseurs standard traditionnels. Une garantie de 5 ans, une durée de vie de 50 000 heures et 50 000 cycles d'allumage et d'extinction sont d'autres avantages. Kanlux XLED EX C35 est en verre avec des filaments visibles qui la rendent similaire aux ampoules à incandescence traditionnelles, mais elle utilise les dernières avancées de la technologie LED.

Une garantie de 5 ans accordée conformément aux termes de la déclaration de garantie disponible sur le site d'Internet

Matériau du diffuseur: verre

ESTREMAMENTE efficienti Kanlux XLED EX C35 3,8W sono sorgenti luminose equivalenti a 60W delle vecchie lampade a incandescenza. La loro eccezionale efficacia luminosa (210 lumen per watt) rende queste sorgenti luminose 15 volte più efficienti dei loro antecedenti tradizionali. Una garanzia di 5 anni unita a 50.000 ore di durata e 50.000 cicli ON/OFF sono ulteriori vantaggi. Kanlux XLEDEX C35 ha un bulbo in vetro e filamenti che le conferiscono un aspetto classico.

5 anni di garanzia secondo le condizioni della dichiarazione di garanzia consultabile sul sito Internet

Diffusore: vetro

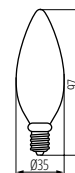

XLED EX C35E14 3,8W

Kanlux XLEDDIM C35

SOURCE LUMINEUSE LED ► LAMPADINA LED



XLEDDIM C35E14 5,9W-WW

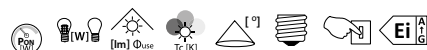

XLEDDIM C35E14 5,9W-WW	35278	5905339352781	5,9	60	806	2700	320	E14	≥25000	D
------------------------	--------------	---------------	-----	----	-----	------	-----	-----	--------	---

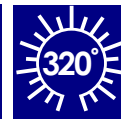
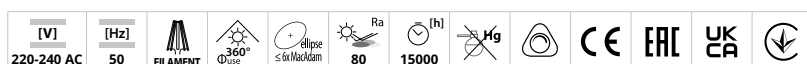

Kanlux XLED combine les meilleures caractéristiques des ampoules à incandescence traditionnelles et des sources de lumière LED actuelles. Voilà pourquoi nous la qualifions de première véritable „ampoule LED”. L'ampoule en verre a la forme d'une „bougie” ordinaire et les LED sont disposées de manière à ce que la lumière se diffuse dans toutes les directions et que l'angle d'éclairage atteigne 320 degrés ! Le XLED DIM C35 peut être utilisé avec un variateur.

Matériau du diffuseur: verre

Kanlux XLED combina le migliori caratteristiche delle lampadine tradizionali e delle moderne sorgenti luminose a LED. Ecco perché la chiamiamo la prima vera "lampadina a LED". La lampadina di vetro ha la forma di una tradizionale "candela" e i LED sono disposti in modo tale che la luce si diffonda in tutte le direzioni e l'angolo di rifrazione della luce sia fino a 320 gradi! XLED DIM C35 è una lampadina dimmerabile

Diffusore: vetro

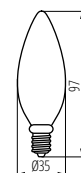

XLEDDIM C35E14 5,9W-WW

Kanlux XLED C35

SOURCE LUMINEUSE LED ► LAMPADINA LED



XLED C35E14 2,5W



Model	Code	Part No.	W	lm	Beam angle (°)	Temp (K)	Base	Life (h)	Temp (K)
XLED C35E14 2,5W-WW	29617	5905339296177	2,5	25	250	2700	E14	≥15000	F
XLED C35E14 4,5W-WW	29618	5905339296184	4,5	40	470	2700	E14	≥15000	F
XLED C35E14 4,5W-NW	29619	5905339296191	4,5	40	470	4000	E14	≥15000	F
XLED C35 E14 6W-WW	35272	5905339352729	6	60	806	2700	E14	≥25000	E
XLED C35 E14 6W-NW	35273	5905339352736	6	60	806	4000	E14	≥25000	E

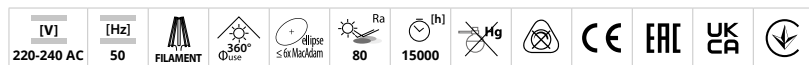

Kanlux XLED combine les meilleures qualités des ampoules traditionnelles et des sources lumineuses LED modernes. C'est pourquoi nous l'appelons la première vraie ampoule LED. La bulbe en verre est de la forme d'une ampoule traditionnelle en forme de chandelle et les diodes LED sont placées de manière à permettre à la lumière de se propager dans toutes les directions. L'angle de faisceau peut atteindre même 320 degrés !

Matériau du diffuseur: verre

Kanlux XLED combina le migliori caratteristiche delle lampade tradizionali con le più moderne lampadine LED. La versione con la classica forma di candela diffonde la luce in modo ampio e uniforme raggiungendo i 320° di rifrazione!

Diffusore: vetro

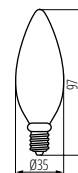

XLED C35 E14

Kanlux XLED C35M

SOURCE LUMINEUSE LED ► LAMPADINA LED



XLED C35E14 4,5W, XLED C35E14 6W



XLED C35E27 6W



Model	Code	Part No.	W	lm	Beam angle (°)	Temp (K)	Base	Life (h)	Temp (K)
XLED C35E14 4,5W-WW-M	29620	5905339296207	4,5	40	470	2700	E14	15000	F
XLED C35E14 4,5W-NW-M	29621	5905339296214	4,5	40	470	4000	E14	15000	F
XLED C35E14 6W-WW-M	29622	5905339296221	6	60	810	2700	E14	10000	D
XLED C35E14 6W-NW-M	29623	5905339296238	6	60	810	4000	E14	10000	D
XLED C35E27 6W-WW-M	29646	5905339296467	6	60	810	2700	E27	10000	D
XLED C35E27 6W-NW-M	29647	5905339296474	6	60	810	4000	E27	10000	D

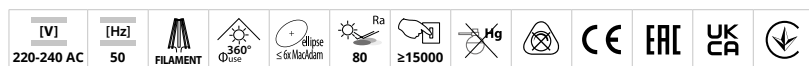

Kanlux XLED combine les meilleures qualités des ampoules traditionnelles et des sources lumineuses LED modernes. C'est pourquoi nous l'appelons la première vraie ampoule LED. La bulbe mate est de la forme d'une ampoule traditionnelle de type « chandelle » et les diodes LED sont placées de manière à permettre à la lumière de se propager dans toutes les directions. L'angle de faisceau peut atteindre même 320 degrés !

Matériau du diffuseur: verre

Kanlux XLED combina le migliori caratteristiche delle lampade tradizionali con le più moderne lampadine LED. Inoltre siamo soliti riferirci a questo tipo di lampada come la prima vera lampada LED. La versione opaca con la classica forma di candela diffonde la luce in modo ampio e uniforme raggiungendo i 320° di rifrazione.

Diffusore: vetro

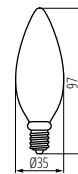

XLED C35E14 4,5W, XLED C35E14 6W

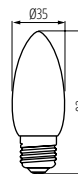

XLED C35E27 6W

Kanlux DUN LED

SOURCE LUMINEUSE LED ► LAMPADINA LED

NEW



DUN 4,9W E14; DUN 6,5W E14

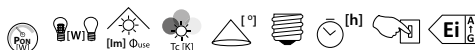

Model	Code	Power [W]	Beam Angle [°]	Beam Diameter [mm]	Temp. [K]	Beam Spread [°]	Wattage [W]	Lifetime [h]	Energy Efficiency Class	
DUN 4,9W E14-WW	23434	5905339234346	4,9	40	470	3000	200	E14	15000 ≥25000	F
DUN 4,9W E14-NW	23435	5905339234353	4,9	40	470	4000	200	E14	15000 ≥25000	F
DUN 6,5W E14-NW	23436	5905339234360	6,5	60	806	4000	200	E14	20000 ≥25000	E
DUN 6,5W E14-WW	23437	5905339234377	6,5	60	806	3000	200	E14	20000 ≥25000	E

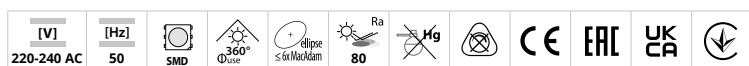

Kanlux IDO LED

SOURCE LUMINEUSE LED ► LAMPADINA LED

NEW



IDO 6,5W E14



Model	Code	Power [W]	Beam Angle [°]	Beam Diameter [mm]	Temp. [K]	Beam Spread [°]	Wattage [W]	Lifetime [h]	Energy Efficiency Class
IDO 6,5W E14-NW	23438	5905339234384	6,5	60	806	4000	200	E14	E
IDO 6,5W E14-WW	23439	5905339234391	6,5	60	806	3000	200	E14	E

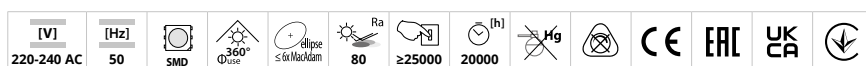

Kanlux DUN de petite taille est une ampoule de type bougie avec culot à vis E14. La durabilité de ce source a été obtenue en combinant des LED CMS et un boîtier en céramique. Les Kanlux DUN se caractérisent par un rendement lumineux élevé. Ils sont parfaits pour les lampes murales et les lustres dans tous les endroits où, malgré une petite source de lumière, l'utilisateur souhaite obtenir beaucoup de lumière.

Matériau: matériau plastique

Kanlux DUN è una piccola lampadina a forma di candela con attacco a vite E14. L'affidabilità e durata di questa lampada sono garantite dalla combinazione dei LED SMD e l'alloggiamento in ceramica. Sono perfette per le lampade di piccole dimensioni o per i lampadari in tutti gli ambienti dove necessitiamo di molta luce con lampadine di piccole dimensioni.

Materiale: plastica

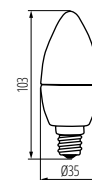

DUN 4,9W E14; DUN 6,5W E14



L'ampoule Kanlux IDO de petite taille est une ampoule de type „bougie” avec un culot E14. La durabilité et l'efficacité énergétique ont été rendues possibles grâce à l'utilisation de LED SMD. Les Kanlux IDO ont une efficacité lumineuse élevée. Elles sont parfaites pour les appliques et les lustres dans tous les endroits où l'on souhaite obtenir beaucoup de lumière.

Matériau: matériau plastique

Matériau du diffuseur: matériau plastique

La piccola Kanlux IDO è una lampadina tipo „candela” con attacco E14. La durata e l'efficienza energetica di queste lampadine sono state rese possibili attraverso l'uso di LED SMD. Le Kanlux IDO hanno un'elevata efficienza luminosa. Sono perfette per lampade da parete e lampadari dove le lampadine sono visibili.

Materiale: plastica

Diffusore: plastica

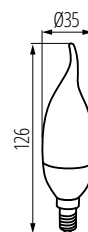

IDO 6,5W E14

IQ-LED G45

SOURCE LUMINEUSE LED ► LAMPADINA LED

NEW



IQ-LED G45E14 3,4W



IQ-LED G45E27 3,4W



IQ-LED G45E14 5,9W



IQ-LED G45E27 5,9W



Kanlux IQ-LED G45 c'est une température de couleur agréable pour les yeux et la fiabilité, tout en conservant le design classique de la sphère. Les nouvelles ampoules IQ-LED Kanlux garantissent une efficacité lumineuse exceptionnelle, jusqu'à 138 lumens par watt et une consommation d'énergie réduite. Les ampoules IQ-LED Kanlux G45 sont disponibles avec des culots E14 et E27. Ces sources lumineuses offrent un confort d'utilisation et une sécurité totale.

Matériau: matériau plastique

Matériau du diffuseur: matériau plastique

Kanlux IQ-LED G45 è sinonimo di affidabilità e sicurezza fotobiologica grazie ad una temperatura ideale per gli occhi. Il tutto in una forma dal design classico. Le lampadine IQ-LED Kanlux hanno anche un'eccezionale efficienza luminosa, fino a 138 lumen per Watt, e quindi proporzionalmente un minore consumo energetico. IQ-LED Kanlux G45 è disponibile in una versione con attacco E14 e E27.

Materiale: plastica

Diffusore: plastica



Model	Code	Power (W)	Power Factor	Beam Angle (°)	Light Output (lm)	Color Temp (K)	Base	Energy Class
IQ-LED G45E14 3,4W-WW	36688	3,4	40	470	2700	150	E14	D
IQ-LED G45E14 3,4W-NW	36689	3,4	40	470	4000	150	E14	D
IQ-LED G45E14 3,4W-CW	36690	3,4	40	470	6500	150	E14	D
IQ-LED G45E27 3,4W-WW	36691	3,4	40	470	2700	150	E27	D
IQ-LED G45E27 3,4W-NW	36692	3,4	40	470	4000	150	E27	D
IQ-LED G45E27 3,4W-CW	36693	3,4	40	470	6500	150	E27	D
IQ-LED G45E14 5,9W-WW	36694	5,9	60	806	2700	150	E14	D
IQ-LED G45E14 5,9W-NW	36695	5,9	60	806	4000	150	E14	D
IQ-LED G45E14 5,9W-CW	36696	5,9	60	806	6500	150	E14	D
IQ-LED G45E27 5,9W-WW	36697	5,9	60	806	2700	150	E27	D
IQ-LED G45E27 5,9W-NW	36698	5,9	60	806	4000	150	E27	D
IQ-LED G45E27 5,9W-CW	36699	5,9	60	806	6500	150	E27	D

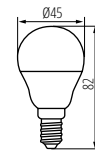

IQ-LED G45E14 3,4W

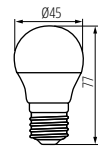

IQ-LED G45E27 3,4W

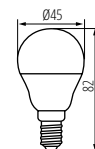

IQ-LED G45E14 5,9W

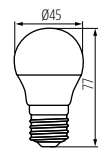

IQ-LED G45E27 5,9W



Kanlux

XLEDEX G45

SOURCE LUMINEUSE LED ► LAMPADINA LED

NEW



XLEDEX G45E14 3,8W



XLEDEX G45E27 3,8W



Les sources lumineuses EXTRÊMEMENT efficaces Kanlux XLED EX G45 3,8W sont équivalentes à des ampoules à incandescence de 60W. L'efficacité lumineuse supérieure à la moyenne (210 lumens par watt) rend ces sources lumineuses 15 fois plus efficaces que leurs prédécesseurs standard traditionnels. Une garantie de 5 ans, une durée de vie de 50 000 heures et 50 000 cycles d'allumage et d'extinction sont d'autres avantages. Kanlux XLED EX G45 est en verre avec des filaments visibles qui la rendent similaire aux ampoules à incandescence traditionnelles, mais elle utilise les dernières avancées de la technologie LED.

Une garantie de 5 ans accordée conformément aux termes de la déclaration de garantie disponible sur le site d'Internet
Matériau du diffuseur: verre

Le Kanlux XLED EX G45 da 3,8W sono estremamente efficienti con un'equivalenza pari a 60W. La loro eccezionale efficienza luminosa (210 lumen per watt) le rende 15 volte più efficienti rispetto alle loro predecessori standard. Vantaggi aggiuntivi includono una garanzia di 5 anni, una durata di 50.000 ore e la capacità di sopportare 50.000 cicli di accensione/spengimento. Inoltre, le Kanlux XLED EX G45 sono dotate di un involucro in vetro simile nella forma alle lampadine tradizionali

5 anni di garanzia secondo le condizioni della dichiarazione di garanzia consultabile sul sito Internet
Diffusore: vetro



Model	Code	Part No.	Power (W)	Light Output (lm)	Beam Angle (°)	Height (mm)	Width (mm)	Base	Class
XLEDEX G45E14 3,8W-WW	37342	5905339373427	3,8	60	806	2700	320	E14	A
XLEDEX G45E14 3,8W-NW	37343	5905339373434	3,8	60	806	4000	320	E14	A
XLEDEX G45E27 3,8W-WW	37344	5905339373441	3,8	60	806	2700	320	E27	A
XLEDEX G45E27 3,8W-NW	37345	5905339373458	3,8	60	806	4000	320	E27	A

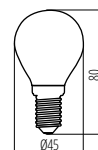

XLEDEX G45E14 3,8W

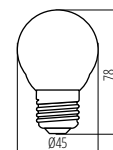

XLEDEX G45E27 3,8W



Kanlux

XLED G45

SOURCE LUMINEUSE LED ► LAMPADINA LED



XLED G45 E14 4,5W



XLED G45 E27 4,5W



XLED G45 E14 6W



XLED G45 E27 6W

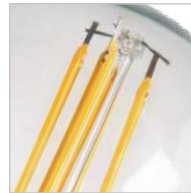

Kanlux XLED combine les meilleures qualités des ampoules traditionnelles et des sources lumineuses LED modernes. C'est pourquoi nous l'appelons la première vraie ampoule LED. La bulbe en verre est de la forme d'une ampoule traditionnelle de type « boule » et les diodes LED sont placées de manière à permettre à la lumière de se propager dans toutes les directions. Nous pouvons choisir entre les sources à culot E27 et E14.

Matériau du diffuseur: verre

Kanlux XLED combina le migliori caratteristiche delle lampadine tradizionali con le più moderne lampadine LED. Inoltre siamo soliti riferirci a questo tipo di lampada come la prima vera lampada LED. Realizzata in vetro a forma di "palla" ha un angolo di emissione ampio. Puoi scegliere fra attacco E27 ed E14.

Diffusore: vetro

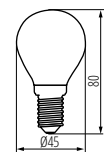

XLED G45 E14

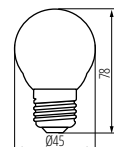

XLED G45 E27



	[W]	[lm]	[°]	[K]	[h]	[h]	[h]	[h]	[h]	[h]
XLED G45 E14 4,5W-WW	29624	5905339296245	4,5	40	470	2700	320	E14	≥15000	F
XLED G45 E27 4,5W-WW	29625	5905339296252	4,5	40	470	2700	320	E27	≥15000	F
XLED G45 E27 6W-WW	35274	5905339352743	6	60	806	2700	320	E27	≥25000	E
XLED G45 E27 6W-NW	35275	5905339352750	6	60	806	4000	320	E27	≥25000	E
XLED G45 E14 6W-WW	35276	5905339352767	6	60	806	2700	320	E14	≥25000	E
XLED G45 E14 6W-NW	35277	5905339352774	6	60	806	4000	320	E14	≥25000	E

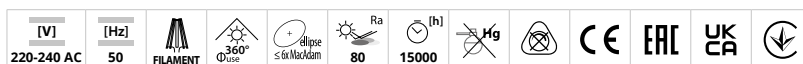

Kanlux

XLED G45M

SOURCE LUMINEUSE LED ► LAMPADINA LED



XLED G45E14 4,5W, XLED G45E14 6W



XLED G45E14 4,5W, XLED G45E14 6W



XLED G45E27 4,5W, XLED G45E27 6W



Kanlux XLED combine les meilleures qualités des ampoules traditionnelles et des sources lumineuses LED modernes. C'est pourquoi nous l'appelons la première vraie ampoule LED. La bulbe mate est de la forme d'une ampoule traditionnelle de type « boule » et les diodes LED sont placées de manière à permettre à la lumière de se propager dans toutes les directions. Nous pouvons choisir entre les sources à culot E27 et E14.

Matériau du diffuseur: verre

Kanlux XLED combina le migliori caratteristiche delle lampade tradizionali con le più moderne lampadine LED. Inoltre siamo soliti riferirci a questo tipo di lampada come la prima vera lampada LED. Realizzata in vetro a forma di "palla" ha un angolo di emissione ampio. Puoi scegliere fra attacco E27 ed E14.

Diffusore: vetro



	[W]	[lm]	Φuse	Tc [K]	[°]	[h]	[h]	[h]	[h]	[h]
XLED G45E14 4,5W-WW-M	29626	5905339296269	4,5	40	470	2700	320	E14	15000	F
XLED G45E14 4,5W-NW-M	29627	5905339296276	4,5	40	470	4000	320	E14	15000	F
XLED G45 E14 6W-WW-M	29628	5905339296283	6	60	810	2700	320	E14	10000	D
XLED G45 E14 6W-NW-M	29629	5905339296290	6	60	810	4000	320	E14	10000	D
XLED G45E27 4,5W-WW-M	29630	5905339296306	4,5	40	470	2700	320	E27	15000	F
XLED G45E27 4,5W-NW-M	29631	5905339296313	4,5	40	470	4000	320	E27	15000	F
XLED G45 E27 6W-WW-M	29632	5905339296320	6	60	810	2700	320	E27	10000	D
XLED G45 E27 6W-NW-M	29633	5905339296337	6	60	810	4000	320	E27	10000	D

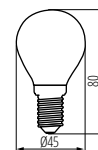

XLED G45E14 4,5W, XLED G45E14 6W

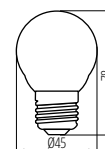

XLED G45E27 4,5W, XLED G45E27 6W

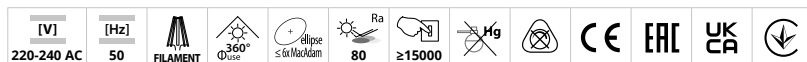

IQ-LEDEX GU10

SOURCE LUMINEUSE LED ► LAMPADINA LED

NEW



IQ-LEDEX GU10 2,5W-NW



IQ-LEDEX GU10 2,5W-NW	33769	5905339337696	2,5	54	460	450	4000	100	GU10	A
-----------------------	--------------	---------------	-----	----	-----	-----	------	-----	------	---

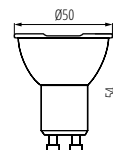
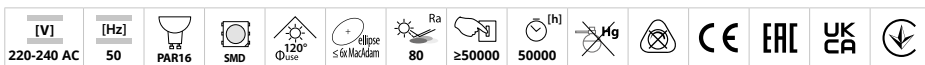

IQ-LEDEX GU10 2,5W-NW



Kanlux iQ-LED EX GU10 est une nouvelle source lumineuse avec un culot GU10 dans la série bien connue et prisée Kanlux iQ-LED. Elle se caractérise par une efficacité lumineuse extrême, ne consomme que 2,5 W d'énergie et fournit autant de lumière qu'une source traditionnelle de 54 W ! 450 lumens de lumière, classe d'efficacité énergétique A, 50 000 heures d'éclairage - voilà les points forts de cette source lumineuse. De plus, Kanlux iQ-LED EX GU10 possède tous les avantages de la série iQ-LED, certifié par le TÜV Rheinland.

Une garantie de 5 ans accordée conformément aux termes de la déclaration de garantie disponible sur le site d'Internet

Matériau du diffuseur: matériau plastique

Kanlux iQ-LED EX GU10 è una nuova sorgente luminosa con attacco GU10 appartenente alla popolare serie di prodotti Kanlux iQ-LED. Caratterizzati da un'estrema efficienza luminosa, consumano solo 2,5W e producono luminosità pari alle tradizionali da 54W! 450 lumen, classe di efficienza energetica "A", 50.000 ore di vita media. Inoltre, il Kanlux iQ-LED EX GU10 ha tutti i vantaggi della serie iQ-LED."

5 anni di garanzia secondo le condizioni della dichiarazione di garanzia consultabile sul sito Internet

Diffusore: plastica

IQ-LED GU10 4,9W

SOURCE LUMINEUSE LED ► LAMPADINA LED

NEW



IQ-LED GU10 4,9W



IQ-LED GU10 4,9W-WW	35256	5905339352569	4,9	44	550	2700	120	GU10	E
IQ-LED GU10 4,9W-NW	35257	5905339352576	4,9	44	550	4000	120	GU10	E
IQ-LED GU10 4,9W-CW	35258	5905339352583	4,9	44	550	6500	120	GU10	E

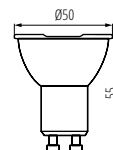
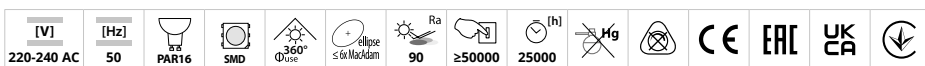

IQ-LED GU10 4,9W



Kanlux IQ-LED GU10 c'est une température de couleur agréable à l'œil et la fiabilité sous la forme classique des ampoules traditionnelle. Les nouvelles ampoules IQ-LED GU10 offrent également une efficacité lumineuse exceptionnelle, plus de 100 lumens par watt, ce qui réduit la consommation d'énergie. Les ampoules IQ-LED GU10 offrent un confort total à l'utilisateur grâce à un rendu fidèle des couleurs (Ra 90).

Matériau: verre

Matériau du diffuseur: matériau plastique

Kanlux IQ-LED GU10 è sinonimo di sicurezza e affidabilità. Le nuove lampadine iQ-LED GU10 di Kanlux offrono anche un'eccezionale efficacia luminosa, più 100 Lumen per Watt, e di conseguenza minore dispendio energetico a parità di prestazioni. Inoltre queste lampadine hanno un elevato indice di resa cromatica (Ra 90).

Materiale: vetro

Diffusore: plastica

Kanlux

IQ-LED GU10

SOURCE LUMINEUSE LED ► LAMPADINA LED



IQ-LED GU10 6,5W



IQ-LED GU10 6,5WS3



Kanlux IQ-LED offre la sécurité photobiologique, une température de couleur respectueuse des yeux et une grande fiabilité. Toutes ces qualités sont disponibles à présent dans la nouvelle variante avec culot GU10. Les ampoules IQ-LED garantissent le plein confort d'utilisation et une sécurité confirmée par le certificat TÜV Rheinland.

Matériau du diffuseur: matériau plastique



Kanlux IQ-LED significa sicurezza fotobiologica, temperatura di colore sicura per i nostri occhi e affidabilità, il tutto abbinato alla nuova versione GU10. Le lampadine IQ LED garantiscono un confort accreditato dalla certificazione indipendente TÜV Rheinland.

Diffusore: plastica



Model	Code	Part No.	W	lm	lm/Use	Tc (K)	Beam	Beam	Beam	Beam	Beam
IQ-LED GU10 6,5W-WW	35240	5905339352408	6,5	59	580	510	2700	110	GU10	F	
IQ-LED GU10 6,5W-NW	35241	5905339352415	6,5	60	585	515	4000	110	GU10	F	
IQ-LED GU10 6,5W-CW	35242	5905339352422	6,5	60	585	515	6500	110	GU10	F	
IQ-LED GU10 6,5WS3-WW	35243	5905339352439	6,5	85	580	535	2700	36	GU10	F	
IQ-LED GU10 6,5WS3-NW	35244	5905339352446	6,5	86	580	540	4000	36	GU10	F	
IQ-LED GU10 6,5WS3-CW	35245	5905339352453	6,5	86	580	540	6500	36	GU10	F	

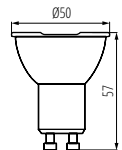

IQ-LED GU10 6,5W

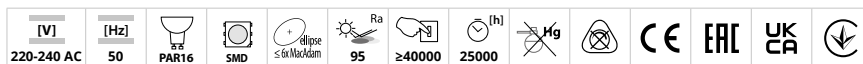

Kanlux

IQ-LEDIM GU10

SOURCE LUMINEUSE LED ► LAMPADINA LED



IQ-LEDDIM GU10 7W



Les LED Kanlux IQ garantissent la sécurité photobiologique et une température de couleur bénéfique pour les yeux. Une nouvelle version avec culot GU10 est désormais disponible. Les ampoules IQ-LED offrent un confort et une sécurité.

Matériau du diffuseur: matériau plastique

Kanlux IQ-LED significa sicurezza fotobiologica, temperatura del colore rispettosa dei tuoi occhi e affidabilità. Ora tutto questo è disponibile anche nel modello GU10 - inoltre, la versione IQ-LEDIM è dimmerabile. Le lampadine IQ-LED offrono il massimo comfort d'uso e sicurezza, come garantito dal certificato TÜV Rheinland.

Diffusore: plastica

			Power	W	lm	lm/Φ _{use}	Φ _{use} (K)	Beam	h	Base	Code
IQ-LEDDIM GU10 7W-WW	35246	5905339352460	7	59	570	490	2700	110	GU10	G	
IQ-LEDDIM GU10 7W-NW	35247	5905339352477	7	60	575	495	4000	110	GU10	G	
IQ-LEDDIM GU10 7W-CW	35248	5905339352484	7	60	575	495	6500	110	GU10	G	

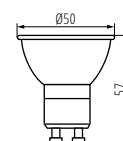
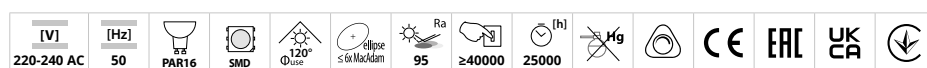

IQ-LEDDIM GU10 7W

Kanlux

K LED GU10 6W

SOURCE LUMINEUSE LED ► LAMPADINA LED



K LED GU10 6W



Kanlux K LED GU10 sont deux types de sources lumineuses LED économiques. Avec un flux lumineux allant jusqu'à 600 lumens, elles peuvent être utilisées dans n'importe quelle pièce comme éclairage d'appoint ou, en combinant plusieurs sources, comme éclairage principal et puissant. Grâce à un choix de deux couleurs (neutre et froide), elles peuvent être adaptées avec succès à nos besoins.

Matériau: matériau plastique

Matériau du diffuseur: matériau plastique

Le Kanlux K LED GU10 sono lampadine led economicamente convenienti. Hanno una potenza fino a 600 lumen che le rende compatibili con qualsiasi ambiente. Ideali come fonte luminosa complementare ed altre o combinata ad altre. Disponibili in bianco neutro e freddo.

Materiale: plastica

Diffusore: plastica

			Power	W	lm	lm/Φ _{use}	Φ _{use} (K)	Beam	h	Base	Code
K LED GU10 6W-NW	36331	5905339363312	6	50	560	500	4000	100	GU10	F	
K LED GU10 6W-CW	36332	5905339363329	6	50	560	500	6500	100	GU10	F	
K LED N GU10 6W-WW	36333	5905339363336	6	50	560	485	3000	100	GU10	F	

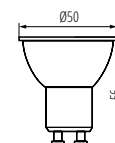
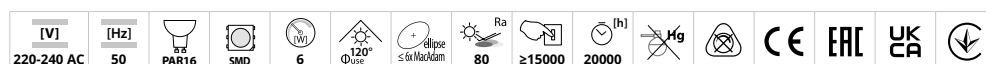

K LED GU10 6W

TOMiv2 LED

SOURCE LUMINEUSE LED ► LAMPADINA LED



Kanlux TOMi v2 est un nouveau design encore plus efficace, garantissant des meilleurs paramètres d'éclairage. Grâce à l'application d'un cache mat, la lumière est distribuée uniformément. Cette lampe se caractérise par une efficacité lumineuse élevée.

Matériau: matériau plastique

Matériau du diffuseur: matériau plastique

Kanlux TOMiv2 garantisce elevati parametri illuminotecnici. Grazie all'utilizzo di un diffusore opaco e alla sua particolare fattura. La luce in queste lampadine è distribuita uniformemente e con un elevato rapporto potenza/efficienza.

Materiale: plastica

Diffusore: plastica

TOMiv2 1,2W GU10



TOMiv2 2,9W GU10

TOMiv2 4,9W GU10

TOMiv2 6,5W GU10

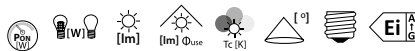

Model	Code	Part No.	Power (W)	Beam Angle (°)	Height (mm)	Width (mm)	Weight (g)	Base	Class
TOMiv2 1,2W GU10-CW	34960	5905339349606	1,2	15	120	105	6500	GU10	F
TOMiv2 1,2W GU10-NW	34961	5905339349613	1,2	15	120	105	4000	GU10	F
TOMiv2 1,2W GU10-WW	34962	5905339349620	1,2	15	120	105	3000	GU10	F
TOMiv2 2,9W GU10-CW	34963	5905339349637	2,9	28	295	240	6500	GU10	F
TOMiv2 2,9W GU10-NW	34964	5905339349644	2,9	28	295	240	4000	GU10	F
TOMiv2 2,9W GU10-WW	34965	5905339349651	2,9	28	295	240	3000	GU10	F
TOMiv2 4,9W GU10-CW	34966	5905339349668	4,9	42	490	400	6500	GU10	F
TOMiv2 4,9W GU10-NW	34967	5905339349675	4,9	42	490	400	4000	GU10	F
TOMiv2 4,9W GU10-WW	34968	5905339349682	4,9	42	490	400	3000	GU10	F
TOMiv2 6,5W GU10-CW	34969	5905339349699	6,5	61	650	530	6500	GU10	F
TOMiv2 6,5W GU10-NW	34970	5905339349705	6,5	61	650	530	4000	GU10	F
TOMiv2 6,5W GU10-WW	34971	5905339349712	6,5	61	650	530	3000	GU10	F

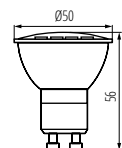

TOMiv2 GU10

[V] 220-240 AC	[Hz] 50	PAR16	SMD	Q _{use} 120°	ellipse ≤ 6° MacAdam	Ra 80	≥15000	25000 [h]	Hg	RoHS	CE	EAC	UKCA	Recycle
-------------------	------------	-------	-----	-----------------------	-------------------------	----------	--------	-----------	----	------	----	-----	------	---------

Kanlux REMI LED

SOURCE LUMINEUSE LED ► LAMPADINA LED



REMI LED GU10



Les sources lumineuses Kanlux REMI LED sont conçues pour les petits luminaires. Leur angle d'éclairage est de 120°. Cette ampoule se distingue par sa petite taille, elle sera donc parfaite pour les petites lampes.

Matériau: matériau plastique

Le lampadine Kanlux REMI LED sono progettate per le lampade di illuminazione di piccole dimensioni. Il loro angolo d'illuminazione raggiunge i 120°. Questa lampadina si distingue per la sua compattezza, quindi è perfetta per le lampade dalle dimensioni piccole.

Materiale: plastica



Model	Code	Power (W)	Beam Angle (°)	Luminous Flux (lm)	Color Temp (K)	Beam Spread (°)	Base	Life (h)
REMI LED GU10-NW	33080	5905339330802	2,2	200	180	4000	GU10	F
REMI LED GU10-WW	33081	5905339330819	2,2	180	165	3000	GU10	F
REMI LED GU10-CW	33082	5905339330826	2,2	200	180	6500	GU10	F

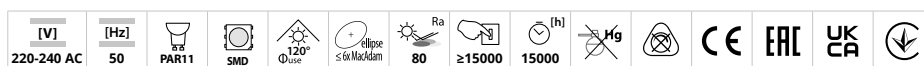
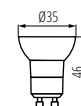

REMI LED GU10

Kanlux TEDI MAXX LED

SOURCE LUMINEUSE LED ► LAMPADINA LED



TEDI MAXX LED GU10



Kanlux TEDI MAXX fournit de la puissance dans une petite lampe. Des LED efficaces et un boîtier en céramique sont quelques-uns des avantages de ces sources. L'alimentation stabilisée minimise l'effet de scintillement qui pourrait causer une fatigue oculaire. De plus, Kanlux TEDI MAXX a un rendement lumineux de 100 lm par watt, et le verre mat utilisé assure une distribution lumineuse uniforme.

Matériau: céramique

Matériau du diffuseur: matériau plastique

Kanlux TEDI MAXX è la potenza racchiusa in un piccolo corpo. I diodi LED efficienti e l'involucro in ceramica sono solo alcuni dei vantaggi di queste sorgenti. L'alimentatore stabilizzato riduce al minimo il fenomeno di sfarfallio che potrebbe causare l'affaticamento della vista. Inoltre, Kanlux TEDI MAXX ha una potenza luminosa di 100 lm/W e il suo vetro opaco garantisce una distribuzione uniforme della luce.

Materiale: ceramica

Diffusore: plastica



Model	Code	Power (W)	Beam Angle (°)	Luminous Flux (lm)	Color Temp (K)	Beam Spread (°)	Base	Life (h)
TEDI MAXX LED GU10-WW	23412	5905339234124	9	65	900	3000	GU10	F
TEDI MAXX LED GU10-CW	23413	5905339234131	9	65	900	6000	GU10	F
TEDI MAXX LED GU10-NW	23414	5905339234148	9	65	900	4000	GU10	F

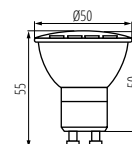

TEDI MAXX LED GU10

Kanlux ZUBI LED

SOURCE LUMINEUSE LED ► LAMPADINA LED

NEW



ZUBI LED 4W G9



ZUBI LED 4W E14



Kanlux ZUBI LED est une source lumineuse LED à haut rendement énergétique. Le flux lumineux élevé de 520 lm et la petite taille de cette source permettent de l'utiliser dans un grand nombre de luminaires. La conception des sources Kanlux ZUBI garantit un large angle d'éclairage, ce qui les rend parfaits pour une utilisation dans tous les luminaires ouverts et les lustres.

Matériau: matériau plastique

Le Kanlux ZUBI LED sono sorgenti luminose a LED, con un elevato flusso luminoso di 520lm e le dimensioni ridotte le rendono compatibili con la maggior parte delle lampade in circolazione. Il design delle sorgenti Kanlux ZUBI garantisce un ampio angolo di rifrazione rendendole ideali per lampade con diffusori aperti

Materiale: plastica



Model	Part No.	Power [W]	Flux [lm]	Temp [K]	Beam angle [°]	Base	Mounting	Life [h]	Class
ZUBI LED 4W G9-CW	24519	4	520	6500	320	G9	≥15000	E	
ZUBI LED 4W G9-VVW	24526	4	520	3000	320	G9	≥15000	E	
ZUBI LED 4W G9-NW	24527	4	520	4000	320	G9	≥15000	E	
ZUBI LED 4W E14-VVW	24528	4	520	3000	320	E14	≥15000	E	
ZUBI LED 4W E14-NW	24529	4	520	4000	320	E14	≥15000	E	

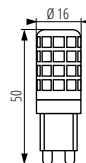
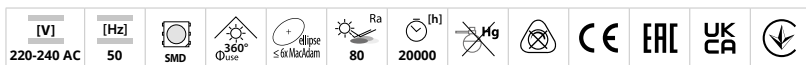

ZUBI LED 4W G9

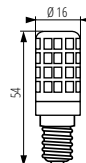

ZUBI LED 4W E14



Kanlux TANO G4

SOURCE LUMINEUSE LED ► LAMPADINA LED



TANO G4 SMD

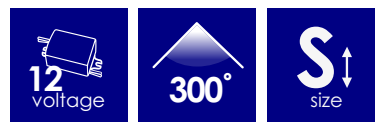

Kanlux TANO est une source LED avec un culot G4. L'angle d'éclairage de cette source est de 300°, sa durée de vie est de 20 000 heures. Les sources Kanlux TANO G4 sont alimentées par une tension de 12V.

Matériau: matériau plastique

Kanlux TANO è una lampadina LED con una attacco G4. L'angolo di rifrazione è molto ampio, pari a 300°, inoltre ha una durata di 20.000 ore. Kanlux TANO G4 è una lampadina a 12V.

Materiale: plastica

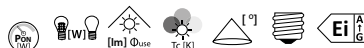

TANO G4 SMD-WW	14936	5907540962483	1,5	11	100	3000	300	G4	G
TANO G4 SMD-NW	14937	5905339149374	1,5	11	105	4000	300	G4	G



TANO G4 SMD

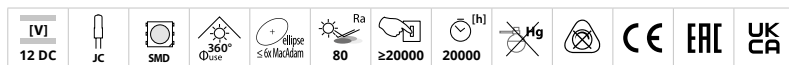

Kanlux LED12 G4

SOURCE LUMINEUSE LED ► LAMPADINA LED



LED12 G4

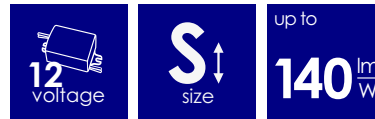

Kanlux LED12 G4 est une lampe LED basée sur de nouvelles LED à haute performance. L'angle d'éclairage de la source est de 120°, durée de vie est de 20.000 heures, et l'efficacité pour la couleur NW est 140 lm/W.

Kanlux LED12 G4 ha una durata media di 20.000 ore, attacco G4, un angolo di rifrazione di 120° ed un'efficienza pari a 140 lm/W.



LED12 G4-WW	18502	5905339185020	1,2	165	135	3000	120	G4	E
LED12 G4-NW	18503	5905339185037	1,2	170	140	4000	120	G4	E

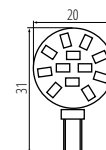

LED12 G4

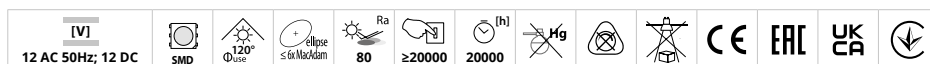

Kanlux

IQ-LED AR-111

SOURCE LUMINEUSE LED ► LAMPADINA LED



IQ-LED AR-111 13W

IQ-LED AR-111 13W-WW	35252	5905339352521	13	107	1050	950	2700	40	G53	G			
IQ-LED AR-111 13W-NW	35253	5905339352538	13	107	1050	950	4000	40	G53	G			

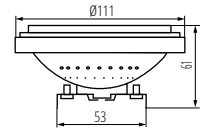

IQ-LED AR-111 13W



Kanlux IQ LED AR-111 est une nouvelle version LED de sources halogènes 12V. Elle se caractérise par une longue durée de vie (45 000 heures) une garantie de 5 ans et une faible consommation électrique. La source est recommandée pour tous les endroits où elle est visible en raison de ses qualités décoratives. Kanlux IQ LED AR-111 offre un très bon rendu des couleurs naturelles Ra>97 et garantis le confort d'utilisation et une sécurité confirmée par le certificat TÜV Rheinland.

Une garantie de 5 ans accordée conformément aux termes de la déclaration de garantie disponible sur le site d'Internet

Matériau du diffuseur: matériau plastique

Kanlux IQ LED AR-111 LED è la versione LED delle tradizionali lampade alogene a 12V. Si caratterizza da una lunga durata (45.000 ore), una garanzia di cinque anni e un basso consumo energetico. È inoltre esteticamente molto pregevole. Le Kanlux IQ-LED AR-111 si distinguono anche per un indice di resa cromatica molto elevato Ra>97, e la certificazione TÜV Rheinland, ne conferma l'elevata sicurezza ed affidabilità.

5 anni di garanzia secondo le condizioni della dichiarazione di garanzia consultabile sul sito Internet

Diffusore: plastica

IQ-LED ES-111

SOURCE LUMINEUSE LED ► LAMPADINA LED



IQ-LED ES-111 12W

IQ-LED ES-111 12W-WW	27318	5905339273185	12	84	950	800	2700	40	GU10	G			
IQ-LED ES-111 12W-NW	27319	5905339273192	12	92	1050	850	4000	40	GU10	G			

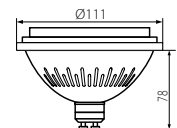
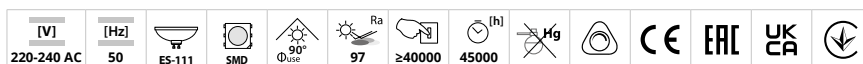

IQ-LED ES-111 12W



Kanlux IQ-LED ES-111 sont des sources lumineuses LED avec un indice de rendu des couleurs très élevé Ra>97. Comme toute la gamme IQ-LED, Kanlux IQ-LED ES-111 sont certifiées par TÜV Rheinland, ce qui confirme leur sécurité. La durée de vie du produit est de 45 000 heures, ce qui nous permet d'offrir une garantie de 5 ans pour ces lampes. Les lampes Kanlux IQ-LED ES-111 peuvent fonctionner avec des variateurs.

Une garantie de 5 ans accordée conformément aux termes de la déclaration de garantie disponible sur le site d'Internet

Matériau du diffuseur: matériau plastique

L Kanlux IQ-LED ES-111 sono moderne lampadine a LED, caratterizzate da un indice di resa cromatica molto elevato Ra>97. Come l'intera serie IQ-LED, le Kanlux IQ-LED ES-111 sono certificate TÜV Rheinland a conferma della loro qualità e sicurezza. Il prodotto ha una durata di 45.000 ore ed una garanzia di 5 anni. Inoltre, le sorgenti Kanlux IQ-LED ES-111 sono compatibili con l'uso di dimmer.

5 anni di garanzia secondo le condizioni della dichiarazione di garanzia consultabile sul sito www.kanlux.com

Diffusore: plastica

Kanlux

IQ-LED EX T8

SOURCE LUMINEUSE LED ▶ LAMPADINA LED

NEW



IQ-LED EX T8 12W



5+
WARRANTY
5 years

up to
210 lm
W

PF >0.9
high

GLASS
tube

Kanlux iQ-LED EX T8 est une nouvelle source lumineuse T8 de la gamme premium. Elle est basée sur des LED de haute performance placées dans un boîtier en verre laiteux afin d'émettre la lumière de manière homogène. Les lampes iQ-LED EX T8 se distinguent par leur qualité de fabrication et l'attention portée aux composants haut de gamme : Une garantie de 5 ans, une durée de vie de 50 000 heures et une efficacité lumineuse extrême allant jusqu'à 210 lumens par watt.

Une garantie de 5 ans accordée conformément aux termes de la déclaration de garantie disponible sur le site d'Internet

Matériau du diffuseur: verre

Kanlux iQ-LED EX T8 è una nuova sorgente luminosa della nota linea premium T8. Costituita da LED ad alte prestazioni posizionati in un corpo di vetro opalino emette luce in modo uniforme. L'alta qualità dei componenti e l'attenzione nel processo di fabbricazione di queste lampade iQ-LED EX T8 ne garantiscono una lunga durata (50.000 ore) ed una garanzia di 5 anni. L'efficienza luminosa è estrema e rappresenta il top di gamma: fino a 210 lumen per Watt.

5 anni di garanzia secondo le condizioni della dichiarazione di garanzia consultabile sul sito www.kanlux.com

Diffusore: vetro

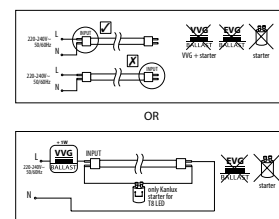

IQ-LED EX T8 12W-NW	35254	5905339352545	12	2520	4000	200	G13	A
IQ-LED EX T8 12W-CW	35255	5905339352552	12	2520	6500	200	G13	A

[V]
220-240 AC

[Hz]
50

T8 LED

SMD

360°
Φuse

ellipse
≤ 6/MaxAdam

Ra
80

≥50000

50000

Hg

ONE SIDE INPUT

CE

EAC

UK CA

E

ACCESSORIES ▶ ACCESSORI

T8 LED STARTER | **26069** | 5905339260697 Replacement LED light switch (26069) | Interruttore luci LED di ricambio (26069)

IQ-LED EX T8 12W

Kanlux

T8 LED GLASSv3

SOURCE LUMINEUSE LED ► LAMPADINA LED



up to

140 $\frac{\text{lm}}{\text{W}}$



Kanlux T8 LED GLASS est une gamme bien connue et éprouvée de lampes fluorescentes basées sur des LED SMD haute performance, qui sont placées dans un corps en verre dépoli. La haute qualité de fabrication et le choix des meilleurs composants sont les caractéristiques de la gamme T8 LED GLASSv3.

Matériau du diffuseur: verre

Kanlux T8 LED GLASS è una nota e collaudata linea di lampade fluorescenti basata sull'utilizzo di LED SMD sistemati in un involucro in vetro lattiginoso. Una lavorazione di alta qualità e la cura nella selezione di componenti di migliore qualità sono le caratteristiche più importanti di T8 LED GLASSv3.

Diffusore: vetro



T8 LED GLASSv3

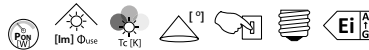

	Power Factor	[lm] Φ_{use}	Tc (K)	θ°	h	Beam Angle	Energy Efficiency Class	
T8 LED GLASSv3 9W-NW	26062	5905339260628	9	1260	4000	250	≥ 15000	G13 D
T8 LED GLASSv3 9W-CW	26063	5905339260635	9	1260	6500	250	≥ 15000	G13 D
T8 LED GLASSv3 18W-NW	26064	5905339260642	18	2520	4000	250	≥ 15000	G13 D
T8 LED GLASSv3 18W-CW	26065	5905339260659	18	2520	6500	250	≥ 15000	G13 D
T8 LED GLASSv3 22W-NW	26058	5905339260581	22	3080	4000	250	≥ 25000	G13 D
T8 LED GLASSv3 22W-CW	26059	5905339260598	22	3080	6500	250	≥ 25000	G13 D

[V] 220-240 AC	[Hz] 50	T8 LED	SMD	Φ_{use} 360°	ellipse $\leq 6^\circ$ MacAdam	Ra 80	h 25000	Hg
		ONE SIDE INPUT	-10+40	CE	ERC	UK CA		

ACCESSORIES ► ACCESSORI

T8 LED STARTER | 26069 | 5905339260697 Replacement LED light switch (26069) | Interruttore luci LED di ricambio (26069)

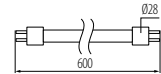

T8 LED GLASSv3 9W

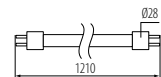

T8 LED GLASSv3 18W

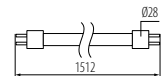

T8 LED GLASSv3 22W

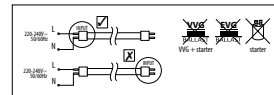

OR

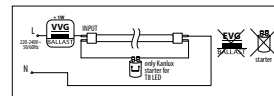

Kanlux

T8 LED GLASSv3T

SOURCE LUMINEUSE LED ► LAMPADINA LED



up to

145 $\frac{\text{lm}}{\text{W}}$



T8 LED GLASS est une gamme bien connue et éprouvée de tubes à LED basés sur des LED SMD de hautes performances. Kanlux T8 LED GLASSv3T est situé dans un corps en verre transparent. Les nouveaux modèles ont un rendement lumineux plus élevé et un angle de diffusion plus étroit de 120°.

Tube LED alimenté par une seule extrémité

Matériau du diffuseur: verre

Kanlux T8 LED GLASS è una nota e collaudata linea di lampade fluorescenti basata sull'utilizzo di LED SMD alloggiati in un vetro trasparente. Una lavorazione di elevata qualità e la cura nella selezione dei componenti sono le caratteristiche più importanti di T8 LED GLASSv3.

Alimentatore unidirezionale LED.

Diffusore: vetro



T8 LED GLASSv3T



	Power Factor	[lm] Φ_{use}	Tc (K)	θ°	h	Beam Angle	Energy Efficiency Class
T8 LED GLASSv3T 18W NW	26068	5905339260680	18	2610	4000	120	G13 D

[V] 220-240 AC	[Hz] 50	T8 LED	SMD	Φ_{use} 360°	ellipse $\leq 6^\circ$ MacAdam	Ra 80	h ≥ 15000	Hg
		ONE SIDE INPUT	-10+40	CE	ERC	UK CA		

ACCESSORIES ► ACCESSORI

T8 LED STARTER | 26069 | 5905339260697 Replacement LED light switch (26069) | Interruttore luci LED di ricambio (26069)

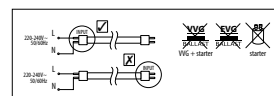

OR

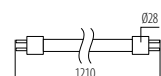
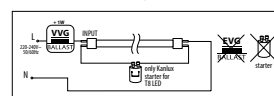

T8 LED GLASSv3T

Kanlux

T8 LED GLASSv4

SOURCE LUMINEUSE LED ► LAMPADINA LED



3
WARRANTY
3 years

up to
160 lm/W

PF >0,9
high

GLASS
tube

Kanlux T8 LED GLASS est une gamme de tubes bien connue et éprouvée. Les diodes LED à haute efficacité, sont placées dans un corps en verre laiteux, ce qui permet d'émettre de la lumière de manière uniforme. La qualité de fabrication et l'attention portée aux composants les plus performants sont les éléments les plus importants de cette ligne de tubes Kanlux T8 LED GLASSv4. En outre, ces tubes ont une garantie de 3 ans et une efficacité lumineuse de 160 lm/W.

Tube LED alimenté par une seule extrémité

Une garantie de 3 ans accordée conformément aux termes de la déclaration de garantie disponible sur le site d'Internet

Matériau du diffuseur: verre

Kanlux T8 LED GLASS appartengono alla già nota famiglia di tubi LED Kanlux e ne rappresentano l'evoluzione in termini di efficienza energetica pari a 160 lm/W. Componenti di elevata qualità. Godono di una garanzia di tre anni.

Alimentatore unidirezionale LED.

Tre anni di garanzia secondo i termini e le condizioni presenti nel sito www.kanlux.com
 Diffusore: vetro



T8 LED GLASSv4

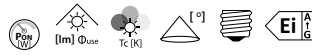

T8 LED GLASSv4 9W-NW	33210	5905339332103	9	1440	4000	220	G13	C
T8 LED GLASSv4 9W-CW	33211	5905339332110	9	1440	6500	220	G13	C
T8 LED GLASSv4 18W-NW	33212	5905339332127	18	2880	4000	220	G13	C
T8 LED GLASSv4 18W-CW	33213	5905339332134	18	2880	6500	220	G13	C
T8 LED GLASSv4 24W-NW	33214	5905339332141	24	3840	4000	220	G13	C
T8 LED GLASSv4 24W-CW	33215	5905339332158	24	3840	6500	220	G13	C

[V] 220-240 AC	[Hz] 50	T8 LED	SMD	360° Φ _{use}	ellipse ≤ 6° MacAdam
Ra 80	≥30000	30000	Hg		
L N ONE SIDE INPUT	-10+40	CE	ERC	UK CA	

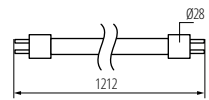
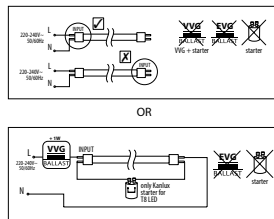

T8 LED GLASSv4 18W

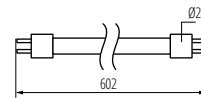

T8 LED GLASSv4 9W

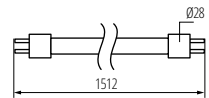

T8 LED GLASSv4 24W

ACCESSORIES ► ACCESSORI

T8 LED STARTER | **26069** | 5905339260697 Replacement LED light switch (26069) | Interruttore luci LED di ricambio (26069)

Kanlux

T8 LED GLASSv5

SOURCE LUMINEUSE LED ► LAMPADINA LED



T8 LED GLASSv5

4
WARRANTY
4 years

up to
185 lm/W

PF >0,9
high

GLASS
tube

Kanlux T8 LED GLASS v5 est la nouvelle version de la populaire gamme de lampes tubes. Elles sont basées sur des LED très efficaces, placées dans un corps en verre laiteux et émettant la lumière de manière uniforme. La qualité de fabrication et l'attention portée aux composants haut de gamme se traduisent par une garantie de 4 ans et une efficacité lumineuse allant jusqu'à 185 lumens par watt.

Une garantie de 4 ans accordée conformément aux termes de la déclaration de garantie disponible sur le site d'Internet

Matériau du diffuseur: verre

Kanlux T8 LED GLASS v5 è l'evoluzione delle precedenti linee T8 Glass. Si basa su LED ad alte prestazioni, integrati in vetro opalino che ne diffonde uniformemente la luminosità. Alta qualità e cura dei migliori componenti caratterizzano queste lampade T8 LED GLASSv5. Garanzia 4 anni ed efficienza pari a 185 lumen/Watt.

Quattro anni di garanzia secondo i termini e le condizioni presenti nel sito www.kanlux.com
 Diffusore: vetro

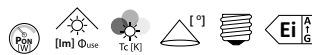

T8 LED GLASSv5 12W-NW	33216	5905339332165	12	2220	4000	200	G13	B
T8 LED GLASSv5 12W-CW	33217	5905339332172	12	2220	6500	200	G13	B

[V] 220-240 AC	[Hz] 50	T8 LED	SMD	360° Φ _{use}	ellipse ≤ 6° MacAdam	Ra 80	≥50000	40000
Hg			L N ONE SIDE INPUT	-10+40	CE	ERC	UK CA	

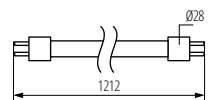
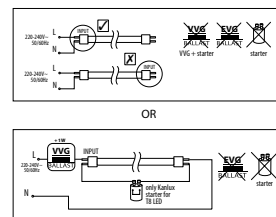

T8 LED GLASSv5 12W

ACCESSORIES ► ACCESSORI

T8 LED STARTER | **26069** | 5905339260697 Replacement LED light switch (26069) | Interruttore luci LED di ricambio (26069)

Kanlux TOMI LED

SOURCE LUMINEUSE LED ► LAMPADINA LED



TOMI LED 5W MR16; 7W MR16

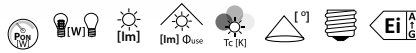

Model	Code	Part No.	W	lm	Beam	Temp	V	Beam	Temp	Temp
TOMI LED 5W MR16-WW	22704	5905339227041	5	26	370	300	3000	120	Gx5,3	G
TOMI LED 5W MR16-CW	22705	5905339227058	5	27	390	310	5300	120	Gx5,3	G
TOMI LED 7W MR16-WW	22706	5905339227065	7	35	570	470	3000	120	Gx5,3	G
TOMI LED 7W MR16-CW	22707	5905339227072	7	35	580	480	5300	120	Gx5,3	G



Kanlux TOMI LED est une source LED de type MR16 durable avec un look classique. Les sources Kanlux LED TOMI utilisent une construction de dissipateur thermique hybride (couche thermoplastique + insert en aluminium), de sorte que l'échange thermique avec l'environnement est beaucoup plus efficace et la durabilité de la source est de 25.000 heures. Le verre mat disperse uniformément la lumière, dont l'angle d'incidence est de 120°.

Matériau du diffuseur: matériau plastique

Kanlux TOMI LED è una sorgente luminosa durevole a LED di tipo MR16 caratterizzata da un aspetto tradizionale. Nelle sorgenti LED Kanlux TOMI è stata impiegata una costruzione ibrida a radiatore (strato di termoplastica + inserto in alluminio), che rende lo scambio termico con l'ambiente molto più efficiente e la loro durata è pari a 25.000 ore. Un vetro opaco diffonde la luce in maniera uniforme, permettendo di ottenere un angolo di incidenza pari a 120°.

Diffusore: plastica

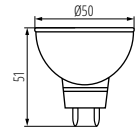

TOMI LED 5W MR16

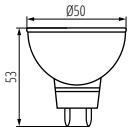

TOMI LED 7W MR16

Kanlux SIGO LED

SOURCE LUMINEUSE LED ► LAMPADINA LED



SIGO R39 LED E14

SIGO R50 LED E14

SIGO R63 LED E27



Model	Code	Part No.	W	lm	Beam	Temp	V	Beam	Temp	Temp
SIGO R39 LED E14-WW	22733	5905339227331	4	29	320	3000	120	E14	G	
SIGO R39 LED E14-NW	22734	5905339227348	4	29	320	4000	120	E14	G	
SIGO R50 LED E14-WW	22735	5905339227355	6	41	490	3000	120	E14	G	
SIGO R50 LED E14-NW	22736	5905339227362	6	41	490	4000	120	E14	G	
SIGO R63 LED E27-WW	22737	5905339227379	8	54	720	3000	120	E27	F	
SIGO R63 LED E27-NW	22738	5905339227386	8	54	720	4000	120	E27	F	

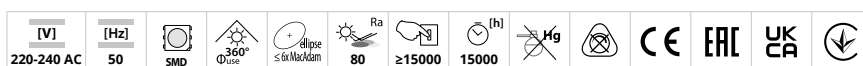

Kanlux SIGO LED n'est pas seulement l'efficacité énergétique, mais aussi la durabilité 25 fois plus élevée que dans les ampoules réflecteurs traditionnelles. Leur forme et leur taille ressemblent à celles des ampoules à réflecteur standard, elles sont donc faciles à remplacer sans aucune modification supplémentaire.

Matériau du diffuseur: matériau plastique

Kanlux SIGO LED è una lampadina ad alta efficienza, con una durata 15 volte superiore ad una ad incandescenza ed un design tradizionale risulta facilmente abbinabile a qualsiasi tipo di lampadario.

Diffusore: plastica

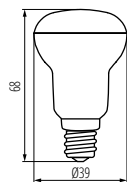

SIGO R39 LED E14

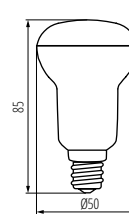

SIGO R50 LED E14

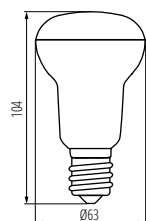

SIGO R63 LED E27

Kanlux ESG LED

SOURCE LUMINEUSE LED ► LAMPADINA LED



ESG LED 9W GX53



Kanlux ESG LED se caractérise par une exécution esthétique et une construction durable. L'abat-jour mat garantit une répartition uniforme et large de la lumière. Le boîtier en aluminium blanc assure une bonne dissipation de la chaleur et les diodes LED CMS haute performance durent 20000h.

Matériau: alliage en aluminium, matériau plastique

Kanlux ESG LED ha un corpo in alluminio che garantisce la dissipazione del calore. I LED SMD permettono una durata pari a 20.000 ore.

Materiale: alluminio, plastica

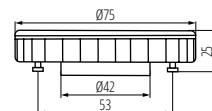

ESG LED 9W GX53

			P _{out} (W)	[lm]	[lm] Φ _{use}	T _c (K)	[°]		Ei
ESG LED 9W GX53-VVV	22422	5905339224224	9	720	595	3000	110	GX53	G
ESG LED 9W GX53-NVV	22423	5905339224231	9	750	600	4000	110	GX53	G
ESG LED 9W GX53-CVV	22424	5905339224248	9	750	600	6000	110	GX53	G

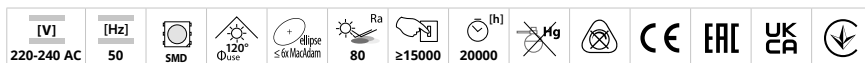

Kanlux RANGO LED

SOURCE LUMINEUSE LED ► LAMPADINA LED



RANGO R7S SMD



RANGO MINI R7S SMD-WW



La source LED Kanlux RANGO est une solution d'économie d'énergie idéale pour toutes sortes de lampes et projecteurs avec un culot R7s.

Matériau: matériau plastique

Matériau du diffuseur: verre

Le lampadine Kanlux RANGO sostituiscono le tradizionali lampade con attacco R7s.

Materiale: plastica

Diffusore: vetro

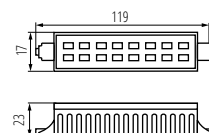

RANGO R7S SMD

			P _{out} (W)	[lm]	[lm] Φ _{use}	T _c (K)	[°]		Ei
RANGO R7S SMD-WW	15098	5907540962155	6	640	550	3000	110	R7s	F
RANGO MINI R7S SMD-WW	15099	5907540962568	6	600	510	3000	110	R7s	F

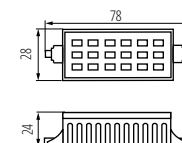
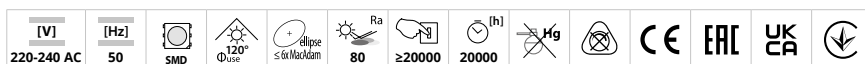

RANGO MINI R7S SMD

Kanlux

MODv2 LED

SOURCE LUMINEUSE LED ► LAMPADINA LED



HIGH
lumen

LED
technology

EASY
installation

Kanlux MOD LED est une série professionnelle de modules à LED conçus pour modifier les lampes dans lesquelles nous avons un ancien type d'ampoule. Le module est facile à assembler. Les diodes Kanlux MOD LED sont des LED CMS de haute qualité qui se distinguent par leur efficacité énergétique et leur longue durée de vie.

Matériau du diffuseur: matériau plastique

Kanlux MOD LED sono una serie di moduli LED destinati a sostituire le tradizionali lampade alogene. I moduli hanno una base magnetica che aderisce perfettamente alle plafoniere tradizionali.

Diffusore: plastica

MODv2 LED 12W



MODv2 LED 12W



MODv2 LED 19W

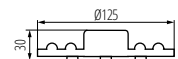

MODv2 LED 12W

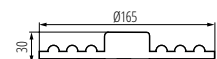

MODv2 LED 19W

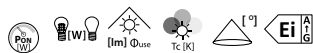

Model	Code	Part No.	Power [W]	Beam Angle [°]	Lumen [lm]	Color Temp [K]	Life [h]	Beam Angle [°]	Class
MODv2 LED 12W-WW	29300	5905339293008	12	82	1200	3000	170	F	
MODv2 LED 12W-NW	29301	5905339293015	12	82	1200	4000	170	F	
MODv2 LED 19W-WW	29302	5905339293022	19	120	2000	3000	170	F	
MODv2 LED 19W-NW	29303	5905339293039	19	120	2100	4000	170	E	

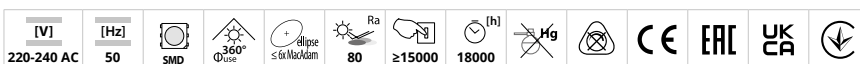

Kanlux LEDS-B

RUBAN LED ► LED STRIP



LEDS-B 4.8W/M IP65



Les Kanlux LEDS-B sont des bandes modernes à caractère décoratif. Idéal pour les applications domestiques où elles peuvent créer des arrangements uniques, limités seulement par notre imagination. Elles se caractérisent par une grande flexibilité, une bonne adhérence et une grande durabilité. Selon les endroits à éclairer ou mettre en valeur, vous pouvez choisir la couleur de la lumière qui convient à vos goûts.

Kanlux LEDS-B sono una famiglia di strip LED dotate di nastro adesivo sul dorso posteriore ed adatte agli utilizzi più svariati. Disponibili con vari gradi IP e differenti gradazione di colore.

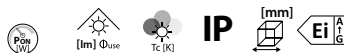

Model	Code	Part No.	Length	Beam Angle	Temp	IP	Length	Temp	Temp
LEDS-B 4,8W/M IP65-WW	24513	5905339245137	0,5m = 2,4	0,5m=200	3000	65	5000	G	
LEDS-B 4,8W/M IP65-NW	24514	5905339245144	0,5m = 2,4	0,5m=220	4000	65	5000	G	
LEDS-B 4,8W/M IP65-CW	24515	5905339245151	0,5m = 2,4	0,5m=225	6500	65	5000	F	
LEDS-B 4,8W/M IP00-WW	24516	5905339245168	0,5m = 2,4	0,5m=225	3000	00	5000	F	
LEDS-B 4,8W/M IP00-NW	24517	5905339245175	0,5m = 2,4	0,5m=235	4000	00	5000	F	
LEDS-B 4,8W/M IP00-CW	24518	5905339245182	0,5m = 2,4	0,5m=250	6500	00	5000	F	

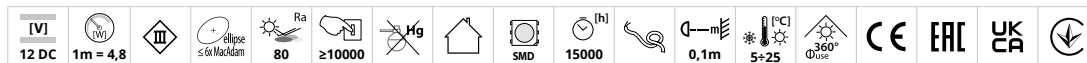

ACCESSORIES ► ACCESSORI

Connector	Code	Part No.	Description
CONNECTOR 8	19030	5905339190307	Connecteur pour bande LED, CONNECTOR 8 (19030) Connettore per striscia LED, CONNECTOR 8 (19030)
CONNECTOR 8-CP	19032	5905339190321	Connecteur pour bande LED, CONNECTOR 8-CP (19032) Connettore per striscia LED, CONNECTOR 8-CP (19032)
CONNECTOR 8-CPC	19033	5905339190338	Connecteur pour bande LED, CONNECTOR 8-CPC (19033) Connettore per striscia LED, CONNECTOR 8-CPC (19033)

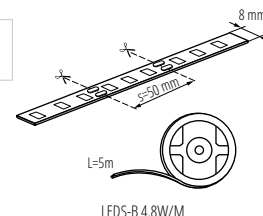

Kanlux

LED STRIP L120 CCT

RUBAN LED ▶ LED STRIP



L120 16W/M 12.IP00CCT



Bande LED Kanlux L120 CCT offre trois couleurs de lumière en une seule bande. Vous pouvez désormais changer la couleur de la lumière en fonction de la situation et de l'humeur. Kanlux L120 CCT a un facteur de rendu des couleurs très élevé CRI90 et une garantie de 3 ans.

Une garantie de 3 ans accordée conformément aux termes de la déclaration de garantie disponible sur le site d'Internet

Kanlux L120 CCT è una strip LED che si caratterizza per poter variare la propria colorazione in tre modi differenti. È possibile scegliere il colore fra luce calda, neutra e fredda. CRI 90 e garanzia di 3 anni.

3 anni di garanzia secondo i termini e le condizioni consultabili nel sito www.kanlux.com
Per un corretto funzionamento sono necessari il relativo controller e telecomando (CTRL 12/24V 10A CCT 22142, REMOTE CCT 22145), entrambi disponibili nel catalogo KANLUX



IP



L120 16W/M 12.IP00CCT | 33317 | 5905339333179 | 0,5m = 4 (WW/CW) | 0,5m = 330 (WW/CW) | 3000/6000 | 00 | 5000 | G

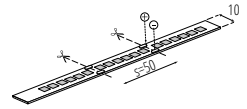

L120 16W/M 12.IP00CCT

[V] 12 DC	[W] 1m = 16	III	ellipse s. G. Masckam	Ra 90	≥30000	Mg	house icon	SMD
[h] 30000	0,1m	5÷25	360° Φuse	CE	ERL	UK	down arrow icon	

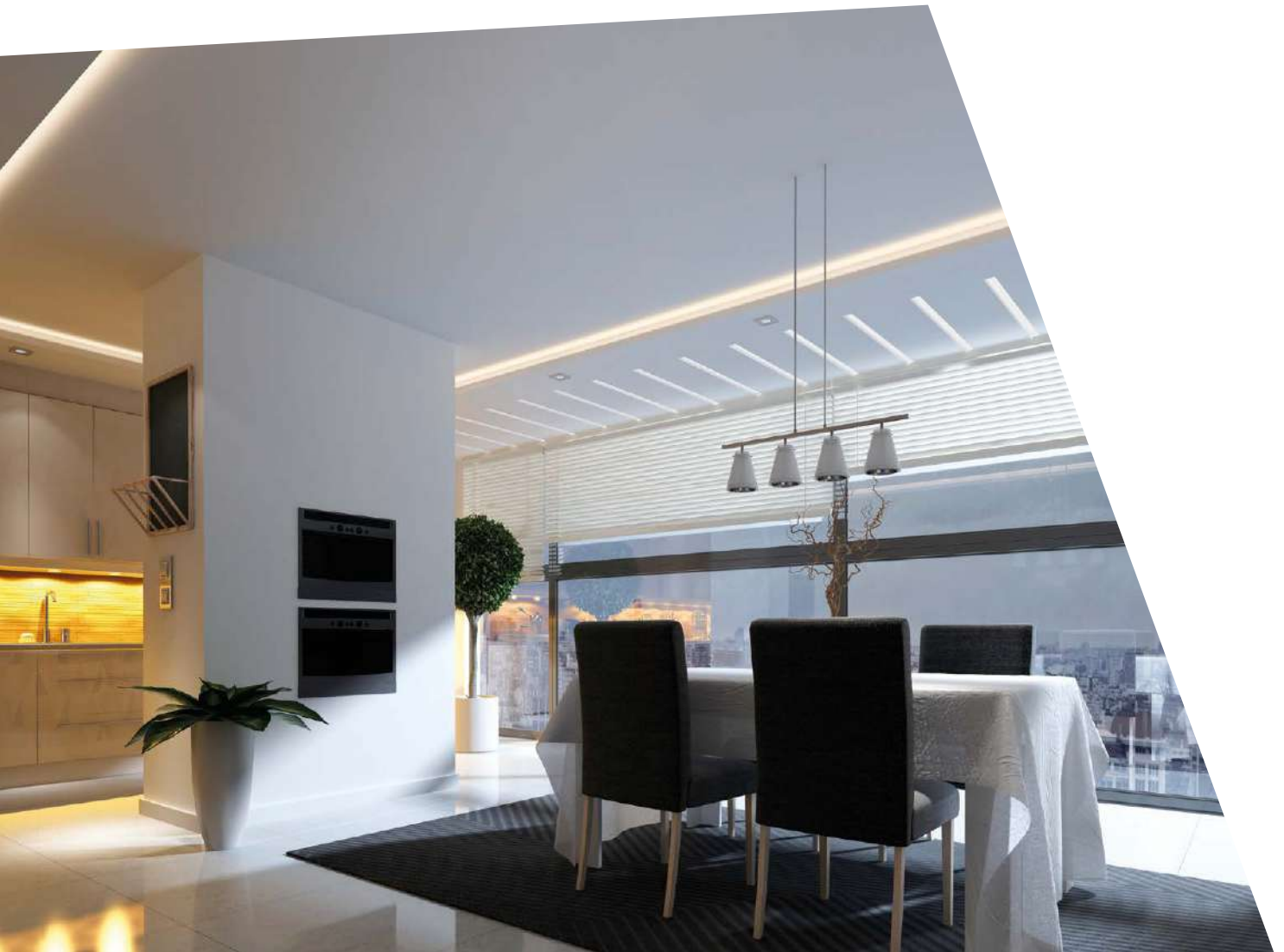

LEDS-B RGB

RUBAN LED ▶ LED STRIP



LEDS-B 7.2W/M IP00RGB



Les Kanlux LEDS-B RGB sont des bandes modernes à caractère décoratif. Idéal pour les applications domestiques où elles peuvent créer des arrangements uniques, limités seulement par notre imagination. Elles se caractérisent par une grande flexibilité, une bonne adhérence et une grande durabilité. Selon les endroits à éclairer ou mettre en valeur, vous pouvez choisir la couleur de la lumière qui convient à vos goûts.

Kanlux LEDS-B RGB è una famiglia di nastri LED RGB. Adatti tanto per un utilizzo commerciale quanto per un utilizzo domestico. Disponibili con IP00, IP54, IP65. Per un utilizzo corretto è necessario abbinarli al relativo controller e telecomando.



Model	Code	Part 1	Part 2	Part 3	Part 4
LEDS-B 7,2W/M IP00RGB	24530	5905339245304	0,5m = 3,6	0,5m = 65	00 5000
LEDS-B 7,2W/M IP65RGB	24531	5905339245311	0,5m = 3,6	0,5m = 65	65 5000
LEDS-B 7,2W/M IP54RGB	24532	5905339245328	0,5m = 3,6	0,5m = 65	54 5000



ACCESSORIES ▶ ACCESSORI

CONNECTOR RGB 10-CP	19036	5905339190369	Connecteur pour bande LED, CONNECTOR RGB 10-CP (19036) Connettore per striscia LED, CONNECTOR RGB 10-CP (19036)
CONNECTOR RGB 10-CPC	19037	5905339190376	Connecteur pour bande LED, CONNECTOR RGB 10-CPC (19037) Connettore per striscia LED, CONNECTOR RGB 10-CPC (19037)
CONNECTOR RGB 10	19038	5905339190383	Connecteur pour bande LED, CONNECTOR RGB 10 (19038) Connettore per striscia LED, CONNECTOR RGB 10 (19038)
CONTROLLER LED RGB-RF	22140	5905339221407	Contrôleur RGB + télécommande, CONTROLLER LED RGB-RF (22140) Controllore RGB + telecomando, CONTROLLER LED RGB-RF (22140)

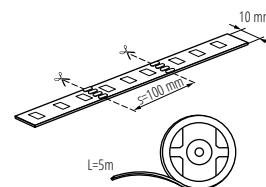

LEDS-B 7,2 W-M IP00 RGB; IP65RGB; IP54RGB

Kanlux

LED STRIP L48 RGBW

RUBAN LED ► LED STRIP



L48 9W/M 24 IP00-RGBW



WARRANTY
3 years

RGB + W

24V

3M
3M
tape

Kanlux L48 est une bande qui vous permet de changer librement la couleur de la lumière. Vous pouvez choisir entre deux versions IP00 et IP65. La version IP65 est conçue pour les endroits où elle peut être exposée à l'humidité, sa taille ne diffère pas beaucoup de celle de la version IP00, ce qui est important pour l'installation de la bande dans des profilés en aluminium.

Une garantie de 3 ans accordée conformément aux termes de la déclaration de garantie disponible sur le site d'Internet

Kanlux L48 è un nastro RGB disponibile con grado IP00 e IP65. Quest'ultimo con dimensioni contenute può essere alloggiato in qualsiasi profilo in alluminio. Per un utilizzo corretto è necessario abbinarlo a relativo telecomando e controller.

3 anni di garanzia secondo i termini e condizioni presenti nel sito www.kanlux.com

Per un corretto funzionamento sono necessari il relativo controller e telecomando (CTRL 12/24V 10A RGBW 22143, REMOTE RGBW 22146), entrambi disponibili nel catalogo KANLUX

L48 9W/M 24 IP00-RGBW	33318	5905339333186	0,5m =2,3 (W)	0,5m = 240 (W)	1m = max 600 (RGBW)	00	5000	F
L48 9W/M 24 IP65-RGBW	33319	5905339333193	0,5m =2,3 (W)	0,5m = 230 (W)	1m = max 550 (RGBW)	65	5000	F

[V]	[W]	III	Tc [K]	allipse	Hg	house	SMD
24 DC	1m = 9 (RGBW)		RGB + 4000(W)	≤ 6xMaxdam	≥30000		
[h]		0,1m	5+25	360°	CE	UK	down arrow
30000							



L48 9W/M 24 IP00-RGBW



L48 9W/M 24 IP65-RGBW

Kanlux

COB SET

KIT LED ► KIT LED



COB SET 3M DIM

COB SET 3m DIM-WW	26326	5905339263261	0,5m = 4	0,5m = 360	3000	00	3000	G
COB SET 3m DIM-NW	26327	5905339263278	0,5m = 4	0,5m = 380	4000	00	3000	F

[V]	[Hz]	PRI [V]	SEC [V]	[W]	III	Ra	Hg	DIMMING function
220-240 AC	50	220-240 AC	12 DC	3m=18		90	≥30000	
house	COB	30000	0,1m	360°	CE	UK	down arrow	

WARRANTY
3 years

Ra90+
true colors

DIMMING
function

Kanlux COB SET est un set composé de trois éléments : un ruban LED de 3m de long, une alimentation et un interrupteur avec une fonction de gradation. Il s'agit d'un kit prêt à l'emploi, qui peut être facilement installé et raccordé à une prise de courant. C'est une solution pratique, qui permet d'ajouter un éclairage spectaculaire sans avoir à creuser les murs pour un câblage supplémentaire.

Une garantie de 3 ans accordée conformément aux termes de la déclaration de garantie disponible sur le site d'Internet

Kanlux COB SET è un set composto da tre elementi: una striscia LED lunga 3 m, un alimentatore e un interruttore con funzione dimmer. È un set pronto all'uso che può essere facilmente installato e collegato alla presa. Questa conveniente soluzione consente di aggiungere un'efficace illuminazione senza la necessità di alcun intervento tecnico o si cablaggio elettrico aggiuntivo.

3 anni di garanzia secondo le condizioni della dichiarazione di garanzia consultabile sul sito Internet

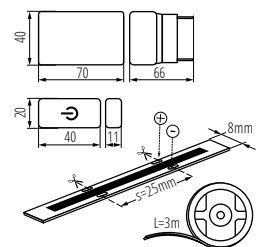

COB SET 3M DIM

CONTROLLER MONO/CCT

CONTRÔLEUR POUR BANDEAUX LED ▶ CONTROLLER PER STRISCE LED



CTRL 12/24V MONO/CCT



Le contrôleur fonctionne avec des bandeaux LED monochromes ainsi qu'avec des bandeaux LED CCT.

Télécommande MONO : 1 canal
Télécommande CCT : 4 canaux

Matériau : plastique
Controller mono e CCT
Telecomando a 1 canale MONO
Telecomando a 4 canali CCT
Materiale: plastica



REMOTE MONO



REMOTE CCT

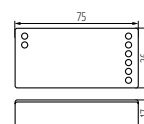

CTRL 12/24V MONO/CCT



CTRL 12/24V MONO/CCT	22147	5905339221476	blanc bianco	12 DC; 24 DC	max 10	max 30
REMOTE MONO	22144	5905339221445	blanc bianco	2 x 1,5 DC	2 x AAA	max 30
REMOTE CCT	22145	5905339221452	blanc bianco	2 x 1,5 DC	2 x AAA	max 30

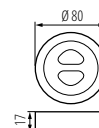

REMOTE MONO

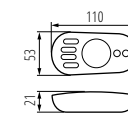

REMOTE CCT



CONTROLLER RGBW CCT

CONTRÔLEUR POUR BANDEAUX LED ▶ CONTROLLER PER STRISCE LED



CTRL 12/24V RGBW CCT



REMOTE RGBW

Le contrôleur fonctionne avec des bandeaux LED monochromes ainsi qu'avec des bandeaux LED RGB/RGBW. Il peut être utilisé avec les télécommandes RGB CCT.

Télécommande RGBW 4 canaux

Matériau : plastique
Il Controller funziona con un colore e con strisce RGB/ RGBW
Può funzionare con i telecomandi RGB CCT.
4 canali RGBW
Materiale: plastica



CTRL 12/24V RGBW CCT	22148	5905339221483	blanc bianco	12 DC; 24 DC	max 10	max 30
REMOTE RGBW	22146	5905339221469	blanc bianco	2 x 1,5 DC	2 x AAA	max 30

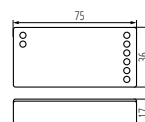

CTRL 12/24V RGBW CCT

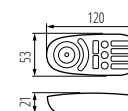

REMOTE RGBW

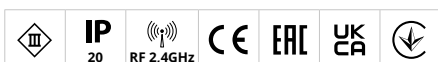

PROFILO B

PROFILÉ EN ALUMINIUM ► PROFILO IN ALLUMINIO



PROFILO B



Petit profilé universel de revêtement pour éclairage et décoration

Matériau: alliage en aluminium

Profilo universale di piccole dimensioni per illuminazione decorativa a montaggio superficiale

Materiale: alluminio



PROFILO B	19161	5905339191618	anodised	Anodizzato	1000
PROFILO B 2m	26540	5905339265401	anodised	Anodizzato	2000

ACCESSORIES ► ACCESSORI

SHADE BVF-FR	26568	5905339265685	Diffuseur transparent pour profilé aluminium, jeu de 10 pcs., SHADE BVF-FR(26568) Cover opaca per profilo in alluminio, confezione 10 pezzi, SHADE BVF-FR (26568)		
SHADE BVF-FR 2M	26570	5905339265708	Diffuseur transparent pour profilé aluminium, jeu de 10 pcs., SHADE BVF-FR 2M(26570) Cover opaca per profilo in alluminio, confezione 10 pezzi, SHADE BVF-FR 2M (26570)		
SHADE BVF-W	26569	5905339265692	Diffuseur opal pour profilé aluminium, jeu de 10 pcs., SHADE BVF-W(26569) Cover bianca per profili in alluminio, confezione 10 pezzi, SHADE BVF-W (26569)		
SHADE BVF-W 2M	26571	5905339265715	Diffuseur opal pour profilé aluminium, jeu de 10 pcs., SHADE BVF-W 2M(26571) Cover bianca per profili in alluminio, confezione 10 pezzi, SHADE BVF-W 2M (26571)		
HANDLE BVF	26596	5905339265968	Support de montage pour profilé aluminium, HANDLE BVF (26596) Supporto per profili in alluminio, HANDLE BVF (26596)		
CONNECT-LB	26604	5905339266040	Connecteur pour profilé aluminium, CONNECT-L B (26604) Connettore angolare per profili in alluminio, CONNECT-L B (26604)		
STOPPER B	19181	5905339191816	Obturateur pour profilé aluminium, STOPPER B (19181) Tappo per profili in alluminio, STOPPER B (19181)		

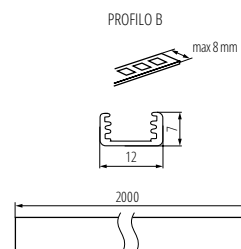
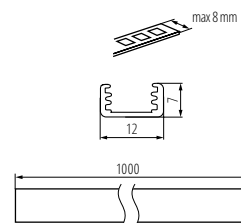

PROFILO B 2M

PROFILO C

PROFILÉ EN ALUMINIUM ► PROFILO IN ALLUMINIO



PROFILO C



PROFILO C	19162	5905339191625	anodised Anodizzato	1000
PROFILO C 2m	26541	5905339265418	anodised Anodizzato	2000

ACCESSORIES ► ACCESSORI

SHADE C\D\EV-FR	26572	5905339265722	Diffuseur transparent pour profilé aluminium, jeu de 10 pcs., SHADE C\D\EV-FR(26572) Cover opaca per profilo in alluminio, confezione 10 pezzi, SHADE C\D\EV-FR (26572)
SHADE C\D\EV-FR2M	26573	5905339265739	Diffuseur transparent pour profilé aluminium, jeu de 10 pcs., SHADE C\D\EV-FR 2M(26573) Cover opaca per profilo in alluminio, confezione 10 pezzi, SHADE C\D\EV-FR 2M (26573)
SHADE C\D\EV-W	26574	5905339265746	Diffuseur opal pour profilé aluminium, jeu de 10 pcs., SHADE C\D\EV-W(26574) Cover bianca per profili in alluminio, confezione 10 pezzi, SHADE C\D\EV-W (26574)
SHADE C\D\EV-W 2M	26575	5905339265753	Diffuseur opal pour profilé aluminium, jeu de 10 pcs., SHADE C\D\EV-W 2M(26575) Cover bianca per profili in alluminio, confezione 10 pezzi, SHADE C\D\EV-W 2M (26575)
SHADE CK C\D\EV-FR	26576	5905339265760	Diffuseur transparent pour profilé aluminium, jeu de 10 pcs., SHADE CK C\D\EV-FR(26576) Cover trasparente per profili in alluminio, confezione 10 pezzi, SHADE CK C\D\EV-FR (26576)
SHADE CK C\D\EV-FR2M	26577	5905339265777	Diffuseur transparent pour profilé aluminium, jeu de 10 pcs., SHADE CK C\D\EV-FR2M(26577) Cover bianca per profili in alluminio, confezione 10 pezzi, SHADE CK C\D\EV-FR2M (26577)
SHADE CK C\D\EV-W	26578	5905339265784	Diffuseur opal pour profilé aluminium, jeu de 10 pcs., SHADE CK C\D\EV-W(26578) Cover bianca per profili in alluminio, confezione 10 pezzi, SHADE CK C\D\EV-W (26578)
SHADE CK C\D\EV-W 2M	26579	5905339265791	Diffuseur opal pour profilé aluminium, jeu de 10 pcs., SHADE CK C\D\EV-W 2M(26579) Cover bianca per profili in alluminio, confezione 10 pezzi, SHADE CK C\D\EV-W 2M (26579)
HANDLE C\D\EV	26597	5905339265975	Support de montage pour profilé aluminium, HANDLE C\D\EV (26597) Supporto per profili in alluminio, HANDLE C\D\EV (26597)
CONNECT C\D\EV	26563	5905339265630	Connecteur pour profilé aluminium, CONNECT C\D\EV(26563) Connettore per profilo alluminio, CONNECT C\D\EV (26563)
CONNECT-L C	26562	5905339265623	Connecteur pour profilé aluminium, CONNECT-L C(26562) Connettore per profilo alluminio, CONNECT-L C (26562)
STOPPER C	19182	5905339191823	Obturbateur pour profilé aluminium, STOPPER C (19182) Tappo per profili in alluminio, STOPPER C (19182)

slide

click

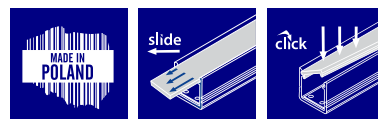

Profilé d'angle (30° et 60°) pour éclairage et décoration

Matériau: alliage en aluminium

Profilo angolare (30° e 60°) per illuminazione decorativa

Materiale: alluminio

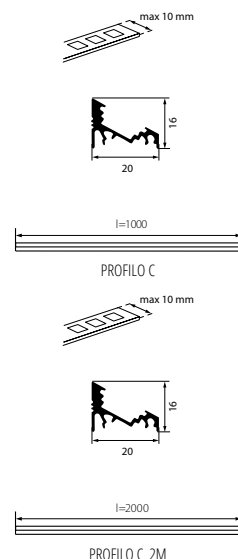

PROFILO D

PROFILÉ EN ALUMINIUM ► PROFILO IN ALLUMINIO



PROFILO D

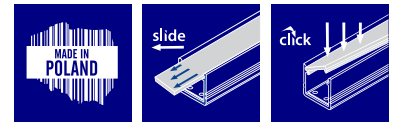

Profilé de revêtement pour éclairage et décoration

Matériau: alliage en aluminium

Profilo per illuminazione decorativa a montaggio superficiale

Materiale: alluminio



PROFILO D	19163	5905339191632	anodised Anodizzato	1000
PROFILO D 2m	26542	5905339265425	anodised Anodizzato	2000

ACCESSORIES ► ACCESSORI

SHADE CVD\EV-FR	26572	5905339265722	Diffuseur transparent pour profilé aluminium, jeu de 10 pcs., SHADE CVD\EV-FR(26572) Cover opaca per profilo in alluminio, confezione 10 pezzi, SHADE CVD\EV-FR (26572)
SHADE CVD\EV-FR2M	26573	5905339265739	Diffuseur transparent pour profilé aluminium, jeu de 10 pcs., SHADE CVD\EV-FR2M(26573) Cover opaca per profilo in alluminio, confezione 10 pezzi, SHADE CVD\EV-FR2M (26573)
SHADE CVD\EV-W	26574	5905339265746	Diffuseur opal pour profilé aluminium, jeu de 10 pcs., SHADE CVD\EV-W(26574) Cover bianca per profili in alluminio, confezione 10 pezzi, SHADE CVD\EV-W (26574)
SHADE CVD\EV-W2M	26575	5905339265753	Diffuseur opal pour profilé aluminium, jeu de 10 pcs., SHADE CVD\EV-W2M(26575) Cover bianca per profili in alluminio, confezione 10 pezzi, SHADE CVD\EV-W2M (26575)
SHADE CK CVD\EV-FR	26576	5905339265760	Diffuseur transparent pour profilé aluminium, jeu de 10 pcs., SHADE CK CVD\EV-FR(26576) Cover trasparente per profili in alluminio, confezione 10 pezzi, SHADE CK CVD\EV-FR (26576)
SHADE CK CVD\EV-FR2M	26577	5905339265777	Diffuseur transparent pour profilé aluminium, jeu de 10 pcs., SHADE CK CVD\EV-FR2M(26577) Cover trasparente per profili in alluminio, confezione 10 pezzi, SHADE CK CVD\EV-FR2M (26577)
SHADE CK CVD\EV-W	26578	5905339265784	Diffuseur opal pour profilé aluminium, jeu de 10 pcs., SHADE CK CVD\EV-W(26578) Cover bianca per profili in alluminio, confezione 10 pezzi, SHADE CK CVD\EV-W (26578)
SHADE CK CVD\EV-W2M	26579	5905339265791	Diffuseur opal pour profilé aluminium, jeu de 10 pcs., SHADE CK CVD\EV-W2M(26579) Cover bianca per profili in alluminio, confezione 10 pezzi, SHADE CK CVD\EV-W2M (26579)
HANDLE CVD\EV	26597	5905339265975	Support de montage pour profilé aluminium, HANDLE CVD\EV (26597) Supporto per profili in alluminio, HANDLE CVD\EV (26597)
CONNECT CVD\EV	26563	5905339265630	Connecteur pour profilé aluminium, CONNECT CVD\EV(26563) Connettore per profilo alluminio, CONNECT CVD\EV (26563)
STOPPER D	19183	5905339191830	Obturbateur pour profilé aluminium, STOPPER D (19183) Tappo per profilo alluminio, STOPPER D (19183)

slide

click

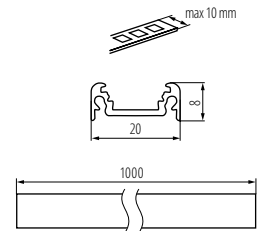

PROFILO D

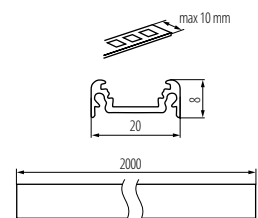

PROFILO D 2M

Kanlux

PROFILO F

PROFILÉ EN ALUMINIUM ► PROFILO IN ALLUMINIO



PROFILO F



Profilé universel pour éclairage et décoration

Matériau: alliage en aluminium

Profilo universale per illuminazione decorativa

Materiale: alluminio



max 10 mm

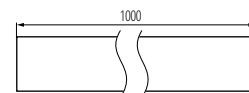

PROFILO F

max 10 mm

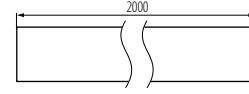

PROFILO F 2M



[mm]

PROFILO F	26552	5905339265524	anodised Anodizzato	1000
PROFILO F 2m	26553	5905339265531	anodised Anodizzato	2000

ACCESSORIES ► ACCESSORI

SHADE BV-FR	26568	5905339265685	Diffuseur transparent pour profilé aluminium, jeu de 10 pcs., SHADE BV-FR(26568) Cover opaca per profilo in alluminio, confezione 10 pezzi, SHADE BV-FR (26568)
SHADE BV-FR 2M	26570	5905339265708	Diffuseur transparent pour profilé aluminium, jeu de 10 pcs., SHADE BV-FR 2M(26570) Cover opaca per profilo in alluminio, confezione 10 pezzi, SHADE BV-FR 2M (26570)
SHADE BV-FW	26569	5905339265692	Diffuseur opal pour profilé aluminium, jeu de 10 pcs., SHADE BV-FW(26569) Cover bianca per profili in alluminio, confezione 10 pezzi, SHADE BV-FW (26569)
SHADE BV-FW 2M	26571	5905339265715	Diffuseur opal pour profilé aluminium, jeu de 10 pcs., SHADE BV-FW 2M(26571) Cover bianca per profili in alluminio, confezione 10 pezzi, SHADE BV-FW 2M (26571)
HANDLE BVF	26596	5905339265968	Support de montage pour profilé aluminium, HANDLE BVF (26596) Supporto per profili in alluminio, HANDLE BVF (26596)
STOPPER F	26590	5905339265906	Obturbateurs pour profilé aluminium, STOPPER F (26590) Tappo per profili in alluminio, STOPPER F (26590)



PROFILO G

PROFILÉ EN ALUMINIUM ► PROFILO IN ALLUMINIO



PROFILO G



Profilé encastrable au sol pour éclairage et décoration

Matériau: alliage en aluminium

Profilo da incasso per illuminazione decorativa di pavimenti

Materiale: alluminio



PROFILO G	26558	5905339265586	anodised Anodizzato	1000
PROFILO G 2m	26559	5905339265593	anodised Anodizzato	2000

ACCESSORIES ► ACCESSORI

SHADE CK G	26580	5905339265807	Diffuseur opal pour profilé aluminium, jeu de 10 pcs., SHADE CK G(26580) Cover bianca per profili in alluminio, confezione 10 pezzi, SHADE CK G (26580)
SHADE CK G 2M	26581	5905339265814	Diffuseur opal pour profilé aluminium, jeu de 5 pcs., SHADE CK G 2M(26581) Cover bianca per profili in alluminio, confezione 5 pezzi, SHADE CK G 2M (26581)
HANDLE G	26598	5905339265982	Support de montage pour profilé aluminium, HANDLE G (26598) Supporto per profili in alluminio, HANDLE G (26598)
STOPPER G	26592	5905339265920	Obturbateurs pour profilé aluminium, STOPPER G (26592) Tappo per profili in alluminio, STOPPER G (26592)
SEALINGS G	26602	5905339266026	Joint d'étanchéité pour profilé aluminium, SEALINGS G (26602) Guarnizione per profili in alluminio, SEALINGS G (26602)

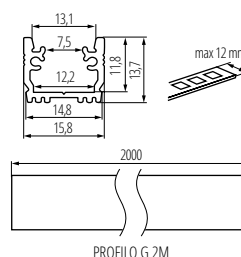
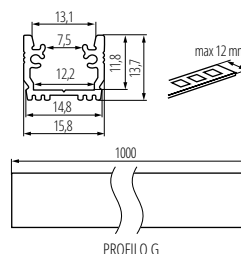

PROFILO H

PROFILÉ EN ALUMINIUM ► PROFILO IN ALLUMINIO



PROFILO H

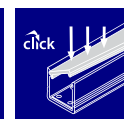

Profilé d'éclairage et de décoration pour applications flexibles dans deux directions d'une seule surface

Matériau: alliage en aluminium

Profilo per illuminazione decorativa, per applicazioni su superfici incurvate in entrambe le direzioni

Materiale: alluminio



(mm)

PROFILO H	26560	5905339265609	anodised Anodizzato	1000
PROFILO H 2m	26561	5905339265616	anodised Anodizzato	2000

ACCESSORIES ► ACCESSORI

SHADE-O H-W	26586	5905339265869	Diffuseur opal pour profilé aluminium, jeu de 10 pcs., SHADE-O H-W(26586) Cover bianca per profili in alluminio, confezione 10 pezzi, SHADE-O H-W (26586)
SHADE-O H-W 2m	26587	5905339265876	Diffuseur opal pour profilé aluminium, jeu de 5 pcs., SHADE-O H-W 2m(26587) Cover bianca per profili in alluminio, confezione 5 pezzi, SHADE-O H-W 2m (26587)
SHADE-U H-FR	26582	5905339265821	Diffuseur transparent pour profilé aluminium, jeu de 10 pcs., SHADE-U H-FR(26582) Cover opaca per profilo in alluminio, confezione 10 pezzi, SHADE-U H-FR (26582)
SHADE-U H-FR 2m	26583	5905339265838	Diffuseur transparent pour profilé aluminium, jeu de 5 pcs., SHADE-U H-FR 2m(26583) Cover opaca per profilo in alluminio, confezione 5 pezzi, SHADE-U H-FR 2m (26583)
SHADE-U H-W	26584	5905339265845	Diffuseur opal pour profilé aluminium, jeu de 10 pcs., SHADE-U H-W(26584) Cover bianca per profilo in alluminio, confezione 10 pezzi, SHADE-U H-W (26584)
SHADE-U H-W 2m	26585	5905339265852	Diffuseur opal pour profilé aluminium, jeu de 5 pcs., SHADE-U H-W 2m(26585) Cover bianca per profilo in alluminio, confezione 5 pezzi, SHADE-U H-W 2m (26585)
HANDLE H	26599	5905339265999	Support de montage pour profilé aluminium, HANDLE H (26599) Supporto per profili in alluminio, HANDLE H (26599)
HANDLE SIDE H	26600	5905339266002	Support de montage pour profilé aluminium, HANDLE SIDE H (26600) Supporto per profili in alluminio, HANDLE SIDE H (26600)
STOPPER-U H	26593	5905339265937	Obturbateurs pour profilé aluminium, STOPPER-U H (26593) Tappo per profili in alluminio, STOPPER-U H (26593)
STOPPER-O H	26594	5905339265944	Obturbateurs pour profilé aluminium, STOPPER-O H (26594) Tappo per profili in alluminio, STOPPER-O H (26594)

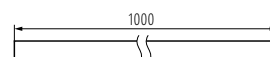
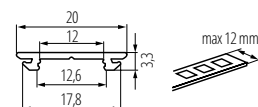

PROFILO H

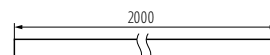
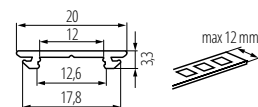

PROFILO H 2M

PROFILO J

PROFILÉ EN ALUMINIUM ► PROFILO IN ALLUMINIO



PROFILO J



PROFILO J-W

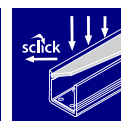

Profilé en applique pour éclairage et décoration

Matériau: alliage en aluminium

Profilo per illuminazione decorativa a montaggio superficiale

Materiale: alluminio



PROFILO	Articolo	Numero	Descrizione	Spessore
PROFILO J	26544	5905339265449	anodised Anodizzato	1000
PROFILO J2M	26545	5905339265456	anodised Anodizzato	2000
PROFILO J-W	26546	5905339265463	blanc bianco	1000
PROFILO J-W2M	26547	5905339265470	blanc bianco	2000

ACCESSORIES ► ACCESSORI

SHADE J/K-FR	26564	5905339265647	Diffuseur transparent pour profilé aluminium, jeu de 10 pcs., SHADE J/K-FR(26564) Cover opaca per profilo in alluminio, confezione 10 pezzi, SHADE J/K-FR (26564)
SHADE J/K-FR 2m	26566	5905339265661	Diffuseur transparent pour profilé aluminium, jeu de 10 pcs., SHADE J/K-FR 2m(26566) Cover opaca per profilo in alluminio, confezione 10 pezzi, SHADE J/K-FR 2m (26566)
SHADE J/K-W	26565	5905339265654	Diffuseur opal pour profilé aluminium, jeu de 10 pcs., SHADE J/K-W(26565) Cover bianca per profili in alluminio, confezione 10 pezzi, SHADE J/K-W (26565)
SHADE J/K-W 2m	26567	5905339265678	Diffuseur opal pour profilé aluminium, jeu de 10 pcs., SHADE J/K-W 2m(26567) Cover bianca per profili in alluminio, confezione 10 pezzi, SHADE J/K-W 2m (26567)
HANDLE J/K	26595	5905339265951	Support de montage pour profilé aluminium, HANDLE J/K (26595) Supporto per profili in alluminio, HANDLE J/K (26595)
STOPPER J	26588	5905339265883	Obturbateurs pour profilé aluminium, STOPPER J (26588) Tappo per profili in alluminio, STOPPER J (26588)
STOPPER J-W	26605	5905339266057	Obturbateurs pour profilé aluminium, STOPPER J-W (26605) Tappo per profili in alluminio, STOPPER J-W (26605)

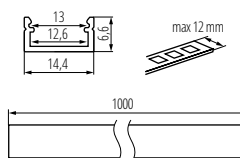

PROFILO J; J-W

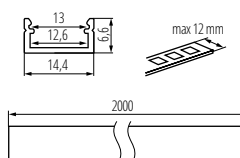

PROFILO J; J-W 2M

PROFILO K

PROFILÉ EN ALUMINIUM ► PROFILO IN ALLUMINIO



PROFILO K



PROFILO K-W

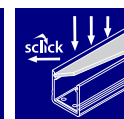

Profilé encastrable pour éclairage et décoration

Matériau: alliage en aluminium

Profilo da incasso per illuminazione decorativa

Materiale: alluminio



PROFILO K	26548	5905339265487	anodised Anodizzato	1000
PROFILO K.2m	26549	5905339265494	anodised Anodizzato	2000
PROFILO K-W	26550	5905339265500	blanc bianco	1000
PROFILO K-W.2m	26551	5905339265517	blanc bianco	2000

ACCESSORIES ► ACCESSORI

SHADE J\K-FR	26564	5905339265647	Diffuseur transparent pour profilé aluminium, jeu de 10 pcs., SHADE J\K-FR(26564) Cover opaca per profilo in alluminio, confezione 10 pezzi, SHADE J\K-FR (26564)
SHADE J\K-FR.2m	26566	5905339265661	Diffuseur transparent pour profilé aluminium, jeu de 10 pcs., SHADE J\K-FR.2m(26566) Cover opaca per profilo in alluminio, confezione 10 pezzi, SHADE J\K-FR.2m (26566)
SHADE J\K-W	26565	5905339265654	Diffuseur opal pour profilé aluminium, jeu de 10 pcs., SHADE J\K-W(26565) Cover bianca per profili in alluminio, confezione 10 pezzi, SHADE J\K-W (26565)
SHADE J\K-W.2m	26567	5905339265678	Diffuseur opal pour profilé aluminium, jeu de 10 pcs., SHADE J\K-W.2m(26567) Cover bianca per profili in alluminio, confezione 10 pezzi, SHADE J\K-W.2m (26567)
HANDLE J\K	26595	5905339265951	Support de montage pour profilé aluminium, HANDLE J\K (26595) Supporto per profili in alluminio, HANDLE J\K (26595)
STOPPER K	26589	5905339265890	Obturbateurs pour profilé aluminium, STOPPER K (26589) Tappo per profili in alluminio, STOPPER K (26589)
STOPPER K-W	26606	5905339266064	Obturbateurs pour profilé aluminium, STOPPER K-W (26606) Tappo per profili in alluminio, STOPPER K-W (26606)

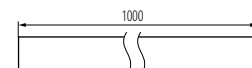
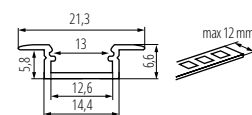

PROFILO K; K-W

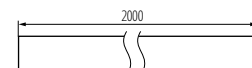
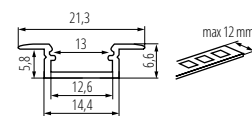

PROFILO K; K-W.2M

Kanlux

NEON LED12W/M

NEON LED ► NEON LED



NEON LED12W/M IP65-WW

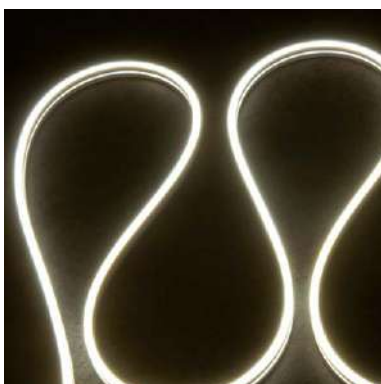

NEON LED12W/M IP65-NW

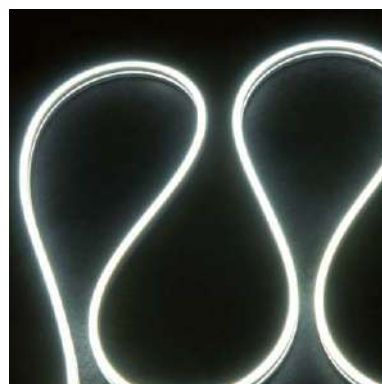

NEON LED12W/M IP65-CW

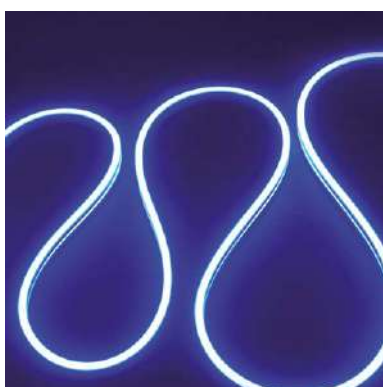

NEON LED12W/M IP65-BL



Kanlux

XLED HP D9

SOURCE LUMINEUSE LED ► LAMPADINA LED

NEW



XLED HP D90E27 26W



Kanlux XLED HP D90E27 est l'équivalent LED des ampoules halogènes spécialisées à culot E27. Cette source lumineuse a une efficacité lumineuse de plus de 150lm/w, ce qui la rend plus efficace que son antécédent halogène et permet d'économiser sur les dépenses d'électricité. Elle a une durée de vie de 25 000 heures.

Une garantie de 3 ans accordée conformément aux termes de la déclaration de garantie disponible sur le site d'Internet

Matériau du diffuseur: verre

Kanlux XLED HP D90E27 è l'equivalente LED di lampadine ad alogenuri con attacco E27. Questa sorgente luminosa professionale ha un'efficacia luminosa di oltre 150 lm/w che la rende più efficiente rispetto alle tradizionali lampade a alogenuri o ioduri metallici. Contribuendo a risparmiare sulle spese di energia elettrica. Inoltre, ha una durata di 25.000 ore.

Tre anni di garanzia secondo i termini e le condizioni presenti nel sito www.kanlux.com
Diffusore: vetro



XLED HP D90E27 26W-NW | 37346 | 5905339373465 | 26 | 227 | 4000 | 4000 | 320 | E27 | D

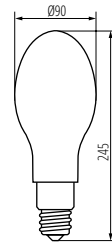
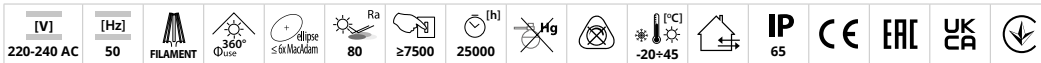

XLED HP D90E27 26W

Kanlux

XLED HP D46

SOURCE LUMINEUSE LED ► LAMPADINA LED

NEW



XLED HP D46E40 38W



Kanlux XLED HP D46E27 est l'équivalent LED des ampoules halogènes à culot E27. Cette source lumineuse a une efficacité lumineuse de plus de 150lm/w, ce qui la rend plus efficace que son antécédent halogène et permet d'économiser sur les dépenses d'électricité. Elle a une durée de vie de 25 000 heures.

Une garantie de 3 ans accordée conformément aux termes de la déclaration de garantie disponible sur le site d'Internet

Matériau du diffuseur: verre

Kanlux XLED HP D90E27 è l'equivalente LED di lampadine ad alogenuri con attacco E27. Questa sorgente luminosa professionale ha un'efficacia luminosa di oltre 150 lm/w che la rende più efficiente rispetto alle tradizionali lampade a alogenuri o ioduri metallici. Contribuendo a risparmiare sulle spese di energia elettrica. Inoltre, ha una durata di 25.000 ore.

Tre anni di garanzia secondo i termini e le condizioni presenti nel sito www.kanlux.com
Diffusore: vetro

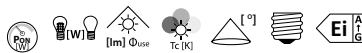

XLED HP D46E40 38W-NW | 37347 | 5905339373472 | 38 | 402 | 7500 | 4000 | 320 | E40 | B

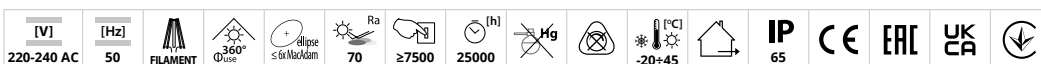

XLED HP D90E27 26W

Kanlux G9 STAR

SOURCE LUMINEUSE HALOGENE ► LAMPADINA ALOGENA

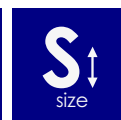

G9-20W; 33W; 48W; 60W STAR

Kanlux G9 STAR est une lampe halogène à culot G9.

Matériau: alliage de métaux inoxydables

Matériau du diffuseur: verre

Kanlux G9 STAR è una lampadina alogena con attacco G9.

Materiale: lega di metalli non corrosivi

Diffusore: vetro

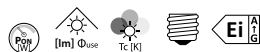

	Power [W]	Part No.	Beam Angle [°]	Temp [K]	Life [h]	Base	Efficiency
G9-20W STAR	18420	5905339184207	20	235	2700	G9	G
G9-33W STAR	18421	5905339184214	33	460	2700	G9	G
G9-48W STAR	18422	5905339184221	48	740	2700	G9	G
G9-60W STAR	18423	5905339184238	60	975	2700	G9	G

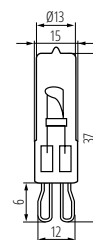

G9-20W; 33W; 48W; 60W STAR

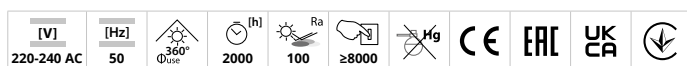

Kanlux J

SOURCE LUMINEUSE HALOGENE ► LAMPADINA ALOGENA



J-1000W 189MM



Les lampes halogènes sont destinées aux luminaires et projecteurs à culot R7s. Les puissances disponibles vont de 1000 W à 1500 W. Elles sont destinées au fonctionnement horizontal.

conçu pour fonctionner à l'horizontale, écart admissible de position de travail de +/-4°

Matériau du diffuseur: verre

Lampadina alogena con attacco R7s. Disponibile nella versione da 1000W o da 1500W. Destinata ad un utilizzo orizzontale.

concepito per un utilizzo su un piano orizzontale. Tollerata un'inclinazione di +/-4°

Diffusore: vetro

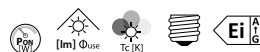

	Power [W]	Part No.	Beam Angle [°]	Temp [K]	Life [h]	Base	Efficiency
J-1000W 189MM	10418	5905339104182	1000	16000	2700	R7s	G

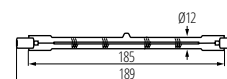

J-1000W 189MM



Kanlux J STAR

SOURCE LUMINEUSE HALOGÈNE ► LAMPADINA ALOGENA



J-80W 78MM STAR

			P _{max} [W]	[lm] Φ _{use}	T _c [K]		Ei
J-80W 78MM STAR	08490	5905339084903	80	1380	2700	R7s	G
J-120W 78MM STAR	08491	5905339084910	120	2230	2700	R7s	G
J-120W 118MM STAR	08500	5905339085009	120	2230	2700	R7s	G

[V]	[Hz]	360° Φ _{use}	[h]	Ra	Hg	CE	EAC	UK CA	↓
220-240 AC	50		2000	100	≥8000				

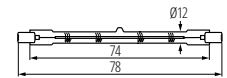

J-80W; 120W 78MM STAR

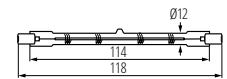

J-120W; 160W; 230W; 400W 118MM STAR



Les lampes halogènes sont destinées aux luminaires et projecteurs à culot R7s. Les puissances disponibles vont de 80 W à 400 W. Elles sont destinées au fonctionnement horizontal. Le flux lumineux de la série STAR et d'environ 23 % plus important par rapport aux halogènes de classe F, tandis que la consommation de courant est d'environ 20 % plus faible.

flux lumineux plus élevé en moyenne de 23%, à une consommation d'énergie réduite de 20% (par rapport à l'halogène de classe F)

conçu pour fonctionner à l'horizontale, écart admissible de position de travail de +/-4°

Matériau du diffuseur: verre

Lampade alogena con attacco R7s. Disponibile nella versioni da 80W o da 400W. Destinate ad un utilizzo orizzontale.

consente un risparmio del 20% (comparato alle tradizionali alogene) ed ha un'efficienza lumen superiore del 23%

destinate ad un utilizzo orizzontale, margine di tolleranza +/-4°

Diffusore: vetro

Kanlux T5

TUBE FLUORESCENT ► LAMPADA FLUORESCENTE LINEARE



T5-8W 4000K/65

			P _{max} [W]	[lm] Φ _{use}	T _c [K]		Ra	[h]	Ei
T5-8W 4000K/65	12715	5905339127150	8	688	4000	G5	65	10000	G
T5-13W 4000K/65	12716	5905339127167	13	1118	4000	G5	65	10000	G
T5-14W 4000K/82	12717	5905339127174	14	1204	4000	G5	82	20000	G

Hg	360° Φ _{use}	CE	EAC	UK CA	↓
----	--------------------------	----	-----	----------	---



Kanlux T5 sont des tubes fluorescents linéaires à trois bandes. Ces lampes offrent plusieurs qualités, comme une faible consommation énergétique et une longue durée de fonctionnement.

T5-8W, T5-13W : lampes fluorescentes à bande, les autres modèles sont des lampes fluorescentes à trois bandes

Matériau: verre

Kanlux T5 sono lampade fluorescenti trifosforo lineari. Il basso consumo energetico e la lunga durata d'esercizio sono senza dubbi vantaggi di queste lampade.

T5-8W, T5-13W: lampade a fluorescenza

Materiale: vetro

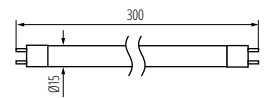

T5-8W 4000K/65

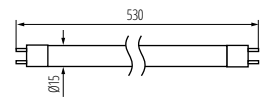

T5-13W 4000K/65

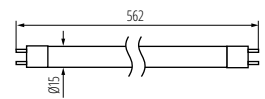

T5-14W 4000K/82

Kanlux

T8

TUBE FLUORESCENT ► LAMPADA FLUORESCENTE LINEARE



T8 36W



T8 18W/840 NW	19921	5905339199218	18	1350	4000	G13	G
T8 18W/865 CW	19922	5905339199225	18	1250	6500	G13	G
T8 36W/840 NW	19924	5905339199249	36	3350	4000	G13	F
T8 36W/865 CW	19925	5905339199256	36	3050	6500	G13	G



Kanlux T8 sont des tubes fluorescents linéaires à trois bandes. Ces lampes offrent plusieurs qualités, comme une faible consommation énergétique et une longue durée de fonctionnement (15 000 h).

Matériau: verre

Kanlux T8 sono lampade fluorescenti trifosforo lineari. Il basso consumo energetico e la lunga durata d'esercizio (15.000 ore) sono senza dubbio i vantaggi principali di queste lampade.

Materiale: vetro

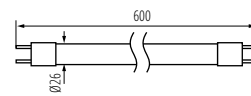

T8 18W

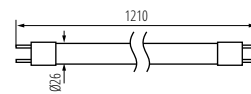

T8 36W

Kanlux

MHE

LAMPE IODURE MÉTALLIQUE ► LAMPADA AGLI ALOGENURI METALLICI



MHE-250W/4200K



MHE-250W/4200K	12755	5905339127556	250	23000	4200	E40	12000	F
MHE-400W/4200K	12756	5905339127563	400	38000	4200	E40	10000	F



Les lampes aux halogénures métalliques Kanlux MHE fonctionnent avec les ballasts pour lampes à sodium à haute pression/lampes aux halogénures métalliques et les dispositifs d'allumage pour lampes aux halogénures métalliques.

Matériau: verre

Le lampade ad alogenuri metallici Kanlux MHE funzionano con resistenze per lampade al sodio/lampade ad alogenuri metallici ad alta pressione e avviatori per lampade ad alogenuri metallici.

Materiale: vetro

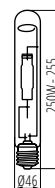

MHE-250W

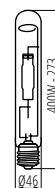

MHE-400W

Kanlux





LUMINAIRES DOMESTIQUES ET DECORATIFS
PRODOTTI DECORATIVI E PER AMBIENTI DOMESTICI

**Nous sommes présents dans votre maison
tous les jours. Vous prenez soin de la beauté
de vos intérieurs et nous nous occupons
de perfectionner nos produits dans les
moindres détails.**

Ci prendiamo cura della funzionalità
e dell'estetica dei nostri prodotti
affinche' valorizzino i vostri ambienti.



*Retrouvez les données photométriques et plugin sur:
curve fotometriche consultabili sul nostro sito:*

► [kanlux.com](https://www.kanlux.com)

Kanlux AGZAR C

SUSPENSION ► LAMPADA A SOSPENSIONE



AGZAR C 3xE14 B

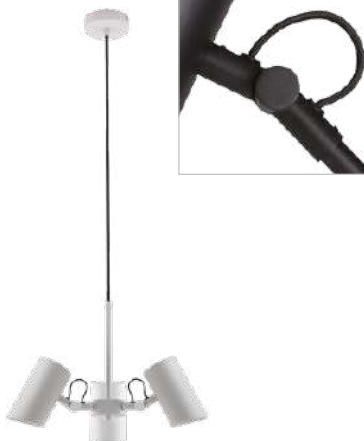

AGZAR C 3xE14 W



Kanlux AGZAR est une gamme de luminaires en métal avec un design original et moderne. Le point fort de ces luminaires est la possibilité de faire pivoter l'abat-jour. Les luminaires sont fabriqués avec soin et sont équipés de câbles tressés. Les suspensions Kanlux AGZAR sont équipées de 3 points lumineux (sources lumineuses avec culot E14 et une puissance maximale de 5W).

Matériau du boîtier: acier

Kanlux AGZAR è un lampadario realizzato interamente in metallo dal design elegante e moderno. Un indubbio vantaggio di questo prodotto è la possibilità di orientarlo a piacere in tutte le direzioni. I cavi sono intrecciati e la lampada è realizzata con cura in ogni dettaglio. Gli apparecchi a sospensione Kanlux AGZAR hanno 3 punti luce (con attacco E14 e potenza massima di 5W) e sono apparecchi di classe PREMIUM.

Materiale del corpo: metallo



AGZAR C 3xE14 B	36252	5905339362520	3 x max 5W	noir nero
AGZAR C 3xE14 W	36253	5905339362537	3 x max 5W	blanc bianco

[V] 220-240 AC	[Hz] 50	E14	IP 20	5+25	180°
3 x 1+2,5	0,5m	CE	EMC	UK	310

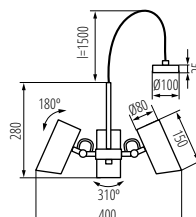

AGZAR C 3XE14

Kanlux GALOBA C

SUSPENSION ► LAMPADA A SOSPENSIONE



GALOBA C 1XGU10 B



GALOBA C 3XGU10 B



GALOBA C 1XGU10 W



GALOBA C 3XGU10 W



GALOBA C 1xGU10 W	33682	5905339336828	max 35	blanc bianco
GALOBA C 1xGU10 B	33683	5905339336835	max 35	noir nero
GALOBA C 3xGU10 W	33684	5905339336842	3 x max 35	blanc bianco
GALOBA C 3xGU10 B	33685	5905339336859	3 x max 35	noir nero

[V] 220-240 AC	[Hz] 50	PAR16	GU10	IP 20	5+25
0,75+1,5	0,5m	CE	EMC	UK	180°



Kanlux GALOBA est une gamme complète de luminaires, comprenant les suspensions (GALOBA C), les appliques murales (GALOBA W) et les accessoires de fixation pour murs et plafonds. Les suspensions GALOBA C de Kanlux peuvent être utilisées pour l'éclairage d'îlots ou de tables, tandis que les appliques et les plafonniers (de 1 à 4 points de lumière) peuvent être utilisées dans un salon, un hall ou une chambre. L'arrangement peut être complété par des appliques murales avec l'interrupteur dans le socle. Tous les luminaires de la gamme GALOBA sont équipés d'un abat-jour amovible grâce auquel les sources lumineuses peuvent être rapidement et confortablement remplacées..

Hauteur maximale de la source lumineuse 55mm

Matériau du boîtier: alliage en aluminium

Kanlux GALOBA è una serie completa di lampade, composta da apparecchi a sospensione (Galoba C), da parete (Galoba W) e da soffitto. Le lampade a sospensione Kanlux GALOBA C possono essere utilizzate con successo nell'illuminazione di isole o tavoli, apparecchi da parete e soffitto (da 1 a 4 punti luce) possono essere utilizzati in soggiorno, ingresso o camera da letto. Disponibili anche con interruttore integrato nella base. L'intera serie di apparecchi Kanlux GALOBA ha un paralume removibile, grazie al quale possiamo sostituire rapidamente e comodamente le lampadine.

Altezza massima della sorgente luminosa 55 mm

Materiale del corpo: alluminio

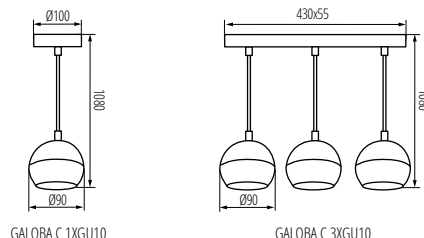

GALOBA C 1XGU10

GALOBA C 3XGU10

Kanlux

JASMIN C

SUSPENSION ► LAMPADA A SOSPENSIONE

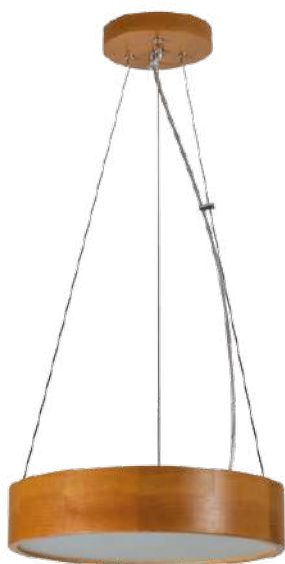

JASMIN C 470-G/O



JASMIN C 270-G/O



JASMIN C 370-G/O



Kanlux JASMIN est une famille de luminaires arrondis, en bois, suspendus, avec une source de lumière remplaçable. Plusieurs tailles et couleurs du plafonnier sont disponibles - chaque version peut être équipée avec 1 à 3 sources lumineuses avec le culot E27. Les luminaires peuvent être accompagnés de spots et de plafonniers de la même gamme.

luminaire suspendu par câbles d'acier
Matériau du boîtier: bois
Matériau du diffuseur: verre

Kanlux JASMIN è una famiglia di apparecchi a sospensione tondi, realizzati in legno, con una sorgente luminosa intercambiabile. Sono disponibili diverse dimensioni e colori della plafoniera, dove possono essere inserite da 1 a 3 sorgenti luminose con attacco E27. Gli apparecchi possono essere integrati con applique o plafoniere della stessa serie.

Materiale del corpo: legno
Diffusore: vetro



JASMIN C 270-G/O	36499	5905339364999	max 20	E27	chêne doré oro quercia
JASMIN C 370-G/O	36500	5905339365002	2 x max 20	E27	chêne doré oro quercia
JASMIN C 470-G/O	36501	5905339365019	3 x max 20	E27	chêne doré oro quercia
JASMIN C 270-W/M	36502	5905339365026	max 20	E27	blanc mat bianco opaco
JASMIN C 370-W/M	36503	5905339365033	2 x max 20	E27	blanc mat bianco opaco
JASMIN C 470-W/M	36504	5905339365040	3 x max 20	E27	blanc mat bianco opaco
JASMIN C 270-B	36505	5905339365057	max 20	E27	noir nero
JASMIN C 370-B	36506	5905339365064	2 x max 20	E27	noir nero
JASMIN C 470-B	36507	5905339365071	3 x max 20	E27	noir nero

[V] 220-240 AC	[Hz] 50	⏚	IP 20	🏠	🌡️ 5-25	⬆️
🔌 0,5m	📏 1	🐜	CE	EAC	UK CA	🔽

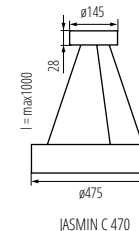
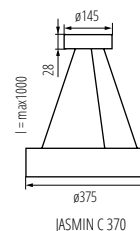
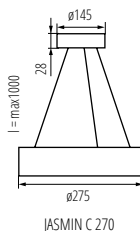

Kanlux ETISSA

SUSPENSION ► LAMPADA A SOSPENSIONE



ETISSA D20 GR



ETISSA D20 GR | 27000 | 5905339270009 | max 40 | gris | grigio

[V] 220-240 AC	[Hz] 50	E27	IP 20	House icon	Temperature icon 5+25	Mounting icon
Box icon	Dimensions icon 0,75+2,5	Cord icon 0,5m	Lightbulb icon	CE	EMC	UKCA



Kanlux ETISSA sont des lampes suspendues compatibles avec toutes les sources de lumière et munies de culot E27. Les luminaires sont fabriqués en béton. Du point de vue du style, il s'agit de produits dans un style austère, typique des lofts, parfaitement adapté à des espaces modernes minimalistes. Leur revêtement est poreux, ce qui est caractéristique des surfaces en béton.

Matériau du diffuseur: moulage en plâtre

Kanlux ETISSA sono lampade a sospensione, adatte a tutte le sorgenti luminose con attacco di tipo E27. Gli apparecchi sono realizzati in calcestruzzo. Dal punto di vista del design si tratta di prodotti mantenuti in uno stile grezzo e sobrio, che si adattano perfettamente a interni moderni e minimalisti. La loro superficie è porosa, caratteristica degli oggetti realizzati in calcestruzzo.

Diffusore: calcestruzzo

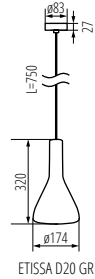

ETISSA D20 GR

Kanlux OGIVA

SUSPENSION ► LAMPADA A SOSPENSIONE



OGIVA D35 GR



OGIVA D35 GR | 27001 | 5905339270016 | max 40 | gris | grigio

[V] 220-240 AC	[Hz] 50	E27	IP 20	House icon	Temperature icon 5+25	Mounting icon
Box icon	Dimensions icon 0,75+2,5	Cord icon 0,5m	Lightbulb icon	CE	EMC	UKCA



Kanlux OGIVA, ce sont des lampes suspendues qui fonctionnent avec toutes les sources lumineuses à culot E27. Les luminaires sont en béton de couleur naturelle (gris). Stylistiquement, ce sont des produits maintenus dans un style brut et post-industriel, parfaitement adaptés aux intérieurs modernes et minimalistes. Leur revêtement est poreux, ce qui est caractéristique des surfaces en béton. Les lampes ont été fabriquées en Pologne.

Matériau du boîtier: alliage en aluminium

Matériau du diffuseur: matériau plastique

Kanlux OGIVA sono lampade a sospensione, adatte a tutte le sorgenti luminose con l'attacco E27. Gli apparecchi sono realizzati in calcestruzzo di colore naturale (grigio). Dal punto di vista estetico si tratta di prodotti mantenuti in uno stile grezzo e sobrio, che si adattano perfettamente a interni moderni e minimalisti. La loro superficie è porosa, caratteristica degli oggetti realizzati in calcestruzzo. Le lampade sono state prodotte in Polonia.

Diffusore: calcestruzzo

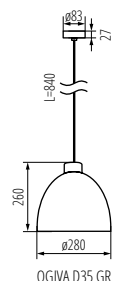

OGIVA D35 GR

Kanlux

SONOR GU10

SPOT ► FARETTO DECORATIVO ORIENTABILE



SONOR GU10 CO-B



SONOR GU10 CO-B WW | 24362 | 5905339243621 | max 10 | noir | nero

[V]	[Hz]	[W]/LED	PAR16	GU10	(lm)	≥15000	(h)	TC (K)
220-240 AC	50	4	PAR16	GU10	100	≥15000	20000	3000
dimse ≤ 6x Maxdam	Ra	SMD			IP		5+25	
	80				20			
	[mm]			CE	ERL	UK		
	1,5-2,5	0,5m						

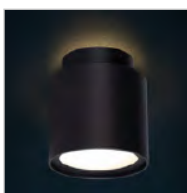

Kanlux SONOR GU10 est un spot avec une bande LED complémentaire sur le dessus. Grâce à deux sources lumineuses indépendantes, cette lampe peut fonctionner selon 3 modes différents: soit uniquement avec une bande LED (idéal comme lumière du soir), soit seulement avec la source du luminaire (à travers l'abat-jour en plastique), et la troisième variante consiste d'allumer les deux sources de lumière simultanément et ainsi utiliser pleinement ses possibilités. Pour un effet optimal, nous recommandons d'utiliser des lampes d'une température de couleur 3000° K. Nous recommandons l'installation Kanlux SONOR par paire afin de profiter pleinement de leurs possibilités d'éclairage

Matériau du boîtier: alliage en aluminium

Matériau du diffuseur: matériau plastique

Kanlux SONOR GU10 è un faretto da soffitto con una striscia LED supplementare. Grazie a due sorgenti luminose indipendenti questa lampada può brillare in tre modi diversi. Solo la striscia LED si illumina (effetto soffitto, ideale come luce da sera), solo la lampadina nell'apparecchio (grazie al paralume in plastica l'apparecchio sembra integrato), la terza opzione è quella di illuminazione da entrambe le sorgenti luminose contemporaneamente e sfruttare appieno le possibilità del faretto. Per un effetto ottimale si consiglia l'uso di lampadine con una temperatura di colore di 3000K. Per il funzionamento delle lampade Kanlux SONOR si consiglia l'uso di un interruttore a due gruppi (doppio) per sfruttare appieno le possibilità di illuminazione di questi apparecchi.

Materiale del corpo: alluminio

Diffusore: plastica

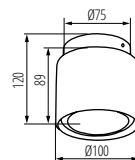

SONOR GU10 CO

Kanlux

SANI IP44

SPOT ► FARETTO DECORATIVO ORIENTABILE



SANI IP44 DSO-B



SANI IP44 DSO-W



SANI IP44 DSO-SN



SANI IP44 DSO-B	29240	5905339292407	max 10	noir nero
SANI IP44 DSO-W	29241	5905339292414	max 10	blanc bianco
SANI IP44 DSO-SN	29242	5905339292421	max 10	Nickel satiné nickel satin

[V]	[Hz]	PAR16	GU10	IP		5+25
220-240 AC	50	PAR16	GU10	44		5+25
	[mm]					
	0,75+1,5	0,5m		CE	ERL	UK



Kanlux SANI IP44 sont des luminaires en saillie. Ils se caractérisent par un style simple et sont disponibles en deux couleurs - blanc et noir. Le degré d'étanchéité IP44 permet de les utiliser dans des pièces humides, comme les salles de bains et les cuisines.

Matériau du boîtier: alliage en aluminium

Matériau du diffuseur: matériau plastique

KANLUX SANI IP44 è una gamma di faretti da soffitto. Sono caratterizzati da uno stile semplice e sono disponibili in due colori - bianco e nero. L'elevato grado di protezione degli apparecchi (IP44) permette di utilizzarli in ambienti dove i dispositivi elettrici sono esposti all'umidità più alta e al rischio di contatto con acqua, ad es. in bagno e in cucina.

Materiale del corpo: alluminio

Diffusore: plastica

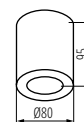

SANI IP44 DSO

AQILO IP65

SPOT ► FARETTO DECORATIVO ORIENTABILE



AQILO IP65 DSO-W



KANLUX AQILO est le premier luminaire Kanlux présentant un degré de protection aussi élevé - IP65. Il se caractérise par un style simple et est disponible en trois coloris : blanc, noir et graphite. L'étanchéité élevée est conçue pour les pièces où les lampes sont exposées à une humidité accrue et à un risque d'inondation, telles que les salles de bains et les cuisines, ainsi que pour les espaces extérieurs de la maison tels que les terrasses, les balcons ou les entrées couvertes. Vous pouvez choisir votre source lumineuse. Un avantage supplémentaire des luminaires AQILO E14 et AQILO E27 est le réflecteur.



Matériau du boîtier: alliage en aluminium

Matériau du diffuseur: matériau plastique

KANLUX AQILO è il primo faretto a plafone Kanlux con un grado IP65. È caratterizzato da uno stile semplice ed è disponibile in tre colori: bianco, nero e grafite. L'elevato grado di resistenza agli agenti atmosferici gli permette di essere impiegato in ambienti esterni, dove le lampade sono esposte all'umidità, ad esempio: bagni e cucine, aree esterne della casa come terrazze, balconi o porticati. È possibile scegliere lampade con attacco e14 (Aquila E14) o E27 (Aquila E27).



Materiale del corpo: alluminio

Diffusore: plastica



AQILO IP65 DSO-W	33360	5905339333605	max 7	blanc bianco
AQILO IP65 DSO-B	33361	5905339333612	max 7	noir nero
AQILO IP65 DSO-GR	33362	5905339333629	max 7	graphite grafite
AQILO E14 IP65 DSO-GR	36640	5905339366405	max 10	graphite grafite
AQILO E14 IP65 DSO-W	36641	5905339366412	max 10	blanc bianco
AQILO E14 IP65 DSO-B	36642	5905339366429	max 10	noir nero
AQILO E27 IP65 DSO-GR	36643	5905339366436	max 20	graphite grafite
AQILO E27 IP65 DSO-W	36644	5905339366443	max 20	blanc bianco
AQILO E27 IP65 DSO-B	36645	5905339366450	max 20	noir nero

[V] 220-240 AC	[Hz] 50	⏚	IP 65	🏠	🌡️ -20+35	⬆️
📦	📏 0,5m	🔧	CE	EAC	UK CA	⬇️

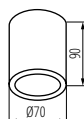

AQILO IP65 DSO

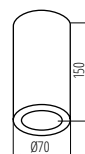

AQILO E14 IP65 DSO

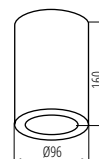

AQILO E27 IP65 DSO

Kanlux

AQILO IP65

SPOT ► FARETTO DECORATIVO ORIENTABILE

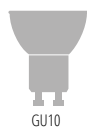

AQILO IP65 DSO-GR



AQILO IP65 DSO-W



AQILO IP65 DSO-B



AQILO E14 IP65 DSO-GR



AQILO E14 IP65 DSO-W



AQILO E14 IP65 DSO-B



AQILO E27 IP65 DSO-GR



AQILO E27 IP65 DSO-W



AQILO E27 IP65 DSO-B



Kanlux STOBI

SPOT ► FARETTO DECORATIVO ORIENTABILE



STOBI DLP 50-B



Kanlux STOBI est la gamme de luminaires de plafond avec une source de lumière remplaçable. Ils sont en aluminium et offrent la possibilité d'orienter l'angle du faisceau lumineux. La finition de haute qualité (surface mate, surface sablée) et le design simple rendent les luminaires parfaits pour l'éclairage des maisons, mais aussi pour les bureaux et les appartements.

Matériau du boîtier: alliage d'aluminium

Kanlux STOBI è la linea di faretti da soffitto con lampadine sostituibili. Sono orientabili ed interamente realizzati in alluminio. La rifinitura di alta qualità (superficie opaca, sabbata) e l'estetica semplice li rendono ideale il loro utilizzo sia in ambienti domestici che in uffici e strutture commerciali.

Materiale del corpo: alluminio



STOBI DLP 50-W



STOBI DLP 250-W

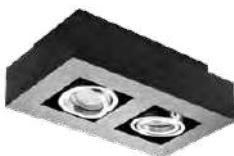

STOBI DLP 250-B



STOBI DLP 50-B	26830	5905339268303	max 10	noir nero
STOBI DLP 50-W	26831	5905339268310	max 10	blanc bianco
STOBI DLP 250-B	26832	5905339268327	2 x max 10	noir nero
STOBI DLP 250-W	26833	5905339268334	2 x max 10	blanc bianco

[V] 220-240 AC	[Hz] 50	 PAR16	 GU10	 IP 20	 5+25	 5+25	 1+2,5	 0,5m				
 60/45												

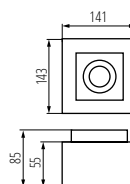

STOBI DLP 50

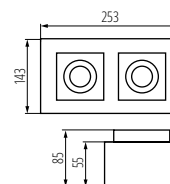

STOBI DLP 250

Kanlux RITI

SPOT ► FARETTO DECORATIVO ORIENTABILE



RITI GU10 W/W



RITI GU10 B/B



RITI GU10 W/G



RITI GU10 B/G



RITI GU10 B/B	27567	5905339275677	max 10	noir nero
RITI GU10 W/W	27569	5905339275691	max 10	blanc bianco
RITI GU10 W/G	27570	5905339275707	max 10	blanc / or bianco / oro
RITI GU10 B/G	27571	5905339275714	max 10	noir / or nero / oro

[V] 220-240 AC	[Hz] 50	PAR16	GU10	⊕	IP 20	⌂	⊕ 5+25	⬆
	 0,75+1,5	 0,5m		CE	ERC	UK CA		

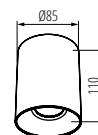

RITI GU10

MO-
DE-
RN
design

HIGH
quality
finish

Kanlux RITI est conçu en aluminium, la structure de la surface sablée est peinte en mat et le réflecteur est recouvert d'une couche de laque or-cuivre avec un pigment brillant. La série Kanlux RITI se caractérise par une bonne qualité de fabrication et un design moderne. On peut l'utiliser comme système d'éclairage autonome ou en combinaison avec plusieurs luminaires.

Matériau du boîtier: alliage en aluminium

Kanlux RITI è un faretto realizzato in alluminio. La struttura del corpo sabbiato è laccata in un elegante bianco o nero opaco. Il faretto Kanlux RITI è caratterizzato da una buona fattura e un design moderno. È possibile usarlo come fonte di illuminazione autonoma o in combinazione con altre lampade. La sostituzione della lampadina è facile e molto rapida. È possibile scegliere una parabola color oro-rame in finitura lucida, bianca o nera. Come opzione aggiuntiva è disponibile la parabola in argento: Kanlux RITI REF. Faretto Kanlux RITI è adatto per il montaggio a soffitto (non da incasso).

Materiale del corpo: alluminio

Kanlux BORD

SPOT ► FARETTO DECORATIVO ORIENTABILE



BORD DLP-50-B



BORD DLP-50-W



BORD DLP-50-W	22551	5905339225511	max 10	blanc mat bianco opaco
BORD DLP-50-B	22552	5905339225528	max 10	mat noir nero opaco

[V] 220-240 AC	[Hz] 50	PAR16	GU10	⊕	IP 20	⌂	⊕ 5+25	⬆	
 25	 0,75+1,5	 0,5m		CE	ERC	UK CA			

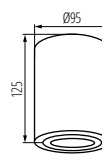

BORD DLP-50



Des bords délicats, des lignes courbes et une forme arrondie confèrent aux luminaires Kanlux BORD une touche d'élégance et de subtilité. Leur design moderne, leur élégance simple et la forme arrondie assurent que ces luminaires s'intégreront aussi bien dans les espaces privés que commerciaux.

Matériau du boîtier: alliage en aluminium

I bordi smussati, le linee curve e la forma slanciata donano agli apparecchi Kanlux BORD eleganza e raffinatezza. Il loro design permettono di abbinare questi faretti sia agli interni residenziali che agli spazi commerciali.

Materiale del corpo: alluminio

Kanlux BORD XS

SPOT ► FARETTO DECORATIVO ORIENTABILE



BORD XS DLP-50-B



BORD XS DLP-50-W



BORD XS DLP-50-B	25478	5905339254788	max 10W	noir nero
BORD XS DLP-50-W	25479	5905339254795	max 10W	blanc bianco

[V]	[Hz]	PAR16 LED	GU10	⊕	IP	°C	↑
220-240 AC	50			20	5+25		
↻	25	1+2,5	0,5m	CE	EAC	UK CA	↓

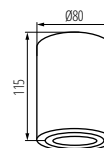

BORD XS DLP-50

Kanlux GORD XS

SPOT ► FARETTO DECORATIVO ORIENTABILE



GORD XS DLP-50-B



GORD XS DLP-50-W



GORD XS DLP-50-B	25476	5905339254764	max 10	noir nero
GORD XS DLP-50-W	25477	5905339254771	max 10	blanc bianco

[V]	[Hz]	PAR16 LED	GU10	⊕	IP	°C	↑
220-240 AC	50			20	5+25		
↻	25	1+2,5	0,5m	CE	EAC	UK CA	↓

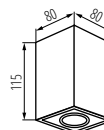

GORD XS DLP-50



Des bords délicats, des lignes courbes et une forme arrondie confèrent aux luminaires Kanlux BORD XS une touche d'élégance et de subtilité. Leur design moderne, leur élégance simple et la forme arrondie assurent que ces luminaires s'intégreront aussi bien dans les espaces privés que commerciaux.

Matériau du boîtier: alliage en aluminium

Bordi delicati, linee curve e una forma aerodinamica conferiscono ai faretti Kanlux BORD XS eleganza e raffinatezza. Il design moderno, l'elegante semplicità e la forma ovale rendono questi apparecchi adatti sia ad interni residenziali che commerciali. Questa è una nuova versione dei famosi faretti Kanlux BORD.

Materiale del corpo: alluminio



Kanlux GORD XS a un nouveau style, plus intéressant que le modèle précédent (Kanlux GORD). Ces luminaires fournissent un éclairage unique qui permet de mettre en valeur certains éléments sélectionnés de la décoration intérieure. La version modifiée de ces luminaires satisfera les amateurs de formes géométriques.

Matériau du boîtier: alliage en aluminium

Kanlux GORD XS ha un nuovo taglio più interessante rispetto al suo predecessore (Kanlux GORD). Questi faretti forniscono un'illuminazione unica che consente di enfatizzare elementi specifici del design degli interni. La versione aggiornata di questi popolari faretti soddisferà gli amanti delle forme geometriche.

Materiale del corpo: alluminio

Kanlux

BLURRO

SPOT ► FARETTO DECORATIVO ORIENTABILE



BLURRO GU10 CO-B



BLURRO GU10 CO-W



HIGH
quality
finish

DESIGN
unique

Les Kanlux BLURRO sont des spots avec le design inhabituel. Le réglage de la direction du faisceau lumineux est un avantage de ces spots avec un ou deux points lumineux. Kanlux BLURRO permettra d'éclairer avec succès le salon, la cuisine et le couloir. Dans les espaces plus vastes, il est conseillé de combiner plusieurs appareils

Matériau du boîtier: alliage en aluminium

Kanlux BLURRO sono lampade da soffitto tipo spot. Il design insolito di questi apparecchi si adatta con successo in molte stanze della casa. Possiamo scegliere una lampada con uno o due punti luce. La loro forma è apparentemente semplice, ma certamente non banale.

Materiale del corpo: alluminio



BLURRO 2xGU10 CO-B	32952	5905339329523	2 x max 10	noir nero
BLURRO 2xGU10 CO-W	32953	5905339329530	2 x max 10	blanc bianco

[W]	[Hz]	PAR16	GU10	IP 20	5+25	60°
220-240 AC	50	0,75+1,5	0,5m	CE	ERL	UK

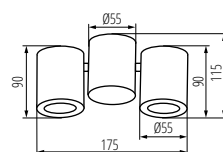

BLURRO 2xGU10 CO

Kanlux

LUMKO LED

PLAFONNIER LED ▶ PLAFONIERA LED

NEW



LUMKO LED 17,5W NW



LUMKO LED 17,5W NW | 37320 | 5905339373205 | 17,5 | LED | 1480 | 4000 | blanc | bianco

[V] 220-240 AC	[Hz] 50	[°] 120	[h] ≥20000	[h] 25000	ellipse ≤ 6x Macadam	Ra 80	Hg X	SMD
[°] IP 20	[°C] 5+25	[mm] 1,5	[m] 0,5m	[m] 0,5m	[m] 1,5	[m] 0,5m	[m] 0,5m	[m] 0,5m
[W] 85	CE	ERC	UK CA	[m] 0,5m	[m] 0,5m	[m] 0,5m	[m] 0,5m	[m] 0,5m

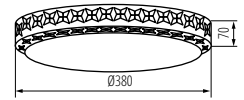

LUMKO LED 17,5W NW



Kanlux LUMKO LED est un plafonnier conçu pour tous ceux qui recherchent une forme simple de luminaire, mais qui ne veulent pas renoncer à une décoration subtile. Kanlux LUMKO LED est de couleur ivoire avec un anneau décoratif dans le socle.

Matériau du boîtier: métal

Matériau du diffuseur: matériau plastique

Kanlux LUMKO LED è una plafoniera da soffitto destinata a tutti coloro che cercano una lampada dalla forma semplice ma al tempo stesso decorata. Kanlux LUMKO LED è color di color avorio e quindi molto facile da abbinareagli ambienti più eterogenei.

Materiale del corpo: metallo

Diffusore: plastica

Kanlux

CARVO LED

PLAFONNIER LED ▶ PLAFONIERA LED

NEW



CARVO LED 17,5W NW



CARVO LED 17,5W NW | 37321 | 5905339373212 | 17,5 | LED | 1320 | 4000 | blanc | bianco

[V] 220-240 AC	[Hz] 50	[°] 120	[h] ≥20000	[h] 25000	ellipse ≤ 6x Macadam	Ra 80	Hg X	SMD
[°] IP 20	[°C] 5+25	[mm] 1,5	[m] 0,5m	[m] 0,5m	[m] 1,5	[m] 0,5m	[m] 0,5m	[m] 0,5m
[W] 75	CE	ERC	UK CA	[m] 0,5m	[m] 0,5m	[m] 0,5m	[m] 0,5m	[m] 0,5m

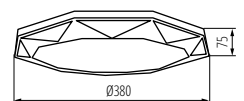

CARVO LED 17,5W NW



Kanlux CARVO LED est un plafonnier dont la forme rappelle celle d'un diamant poli. Les formes géométriques élégantes conviendront aux intérieurs modernes et la lumière subtile du plafonnier éclairera les pièces de petite et moyenne taille.

Matériau du boîtier: métal

Matériau du diffuseur: matériau plastique

Kanlux CARVO LED è una plafoniera che riecheggia le forme eleganti e geometriche dei diamanti. Il design moderno si attaglia a interni e agli ambienti di piccole e medie dimensioni.

Materiale del corpo: metallo

Diffusore: plastica

Kanlux BONSA LED

PLAFONNIER LED ▶ PLAFONIERA LED

NEW



BONSA LED 17,5W NW



BONSA LED 17,5W NW | 37322 | 5905339373229 | 17,5 | LED | 1580 | 4000 | blanc | bianco

[V] 220-240 AC	[Hz] 50	[°] 120	[h] ≥20000	[h] 25000	ellipse ≤ 6x Nachdam	Ra 80	Hg	SMD
		IP 20	5+25			1,5	0,5m	
lm W 90	CE	EAC	UK CA					

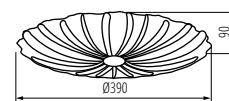

BONSA LED 17,5W NW



Le Plafonnier Kanlux BONSA LED sera appréciée par les amateurs de vintage, mais aussi par les amoureux du style anglais. La lumière de Kanlux BONSA LED est distribuée de manière intéressante grâce à la forme et à la texture de l'abat-jour.

Matériau du boîtier: métal

Matériau du diffuseur: matériau plastique

La lampada da soffitto Kanlux BONSA LED è un plafoniera dal design classico. Sarà apprezzata dagli amanti del vintage ma anche da coloro che apprezzano lo stile inglese. Il paralume diffonde la luce della Kanlux BONSA in modo soffuso.

Materiale del corpo: metallo

Diffusore: plastica

Kanlux EXATE LED

PLAFONNIER LED ▶ PLAFONIERA LED

NEW



EXATE LED 17,5W NW



EXATE LED 17,5W NW | 37323 | 5905339373236 | 17,5 | LED | 1420 | 4000 | blanc | bianco

[V] 220-240 AC	[Hz] 50	[°] 120	[h] ≥20000	[h] 25000	ellipse ≤ 6x Nachdam	Ra 80	Hg	SMD
		IP 20	5+25			1,5	0,5m	
lm W 81	CE	EAC	UK CA					

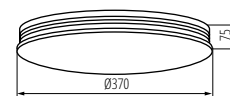

EXATE LED 17,5W NW



Le plafonnier Kanlux EXATE LED est une lampe de forme moderne. Le design simple et minimaliste est délicatement souligné par de fins anneaux métalliques. Elle sera appréciée par les amateurs de style moderne, ainsi que par ceux qui aiment le minimalisme.

Matériau du boîtier: métal

Matériau du diffuseur: matériau plastique

La lampada da soffitto Kanlux EXATE LED ha una forma moderna. Il design semplice, minimalista è sottolineato dagli anelli anelli metallici in stile Deco

Materiale del corpo: metallo

Diffusore: plastica

Kanlux SOLN LED

PLAFONNIER LED ▶ PLAFONIERA LED

NEW



SOLN LED 17,5W NW B/G



SOLN LED 17,5W NW B/G | 37324 | 5905339373243 | 17,5 | LED | 945 | 4000 | noir / or | nero / oro

[V] 220-240 AC	[Hz] 50	[°] 120	≥20000	[h] 25000	ellipse ≤ 6x MacAdam	Ra 80	Hg	SMD
		IP 20	°C 5+25			1,5	0,5m	
lm 54	CE	ERC	UK CA					



SOLN LED 17,5W NW B/G



Kanlux SOLN LED est un luminaire qui reflète les dernières tendances de la décoration d'intérieur. Cette lampe fait référence au style art déco sophistiqué, qui est associé au luxe, aux textures expressives et à l'utilisation de surfaces brillantes, y compris d'accessoires dorés. L'abat-jour noir et or de la lampe Kanlux SOLN LED ne passera pas inaperçu dans l'intérieur et deviendra sa décoration centrale.

Matériau du boîtier: métal

Matériau du diffuseur: matériau plastique

Kanlux SOLN LED è una plafoniera di design ispirata alle Line in stile deco'. È raffinata ed essenziale. I Colori predominanti sono il nero e l'oro e si tagliano perfettamente con la luce che promana dal di opalino.

Materiale del corpo: metallo

Diffusore: plastica

Kanlux AMAZI LED

PLAFONNIER LED ▶ PLAFONIERA LED

NEW



AMAZI LED 17,5W NW B



AMAZI LED 17,5W NW B | 37325 | 5905339373250 | 17,5 | LED | 925 | 4000 | noir | nero

[V] 220-240 AC	[Hz] 50	[°] 120	≥20000	[h] 25000	ellipse ≤ 6x MacAdam	Ra 80	Hg	SMD
		IP 20	°C 5+25			1,5	0,5m	
lm 53	CE	ERC	UK CA					

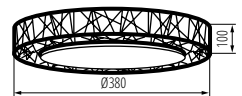

AMAZI LED 17,5W NW B



Kanlux AMAZI LED est un plafonnier unique. Il se distingue de ce type de luminaires par son abat-jour en forme géométrique, qui le rend non seulement pratique mais surtout décoratif.

Matériau du boîtier: métal

Matériau du diffuseur: matériau plastique

Kanlux AMAZI LED è una lampada dal design originale e articolato. I motivi geometrici neri sono molto caratteristici. Kanlux AMAZI LED gioca con la geometria

Materiale del corpo: metallo

Diffusore: plastica

Kanlux

VAND LED

PLAFONNIER LED ▶ PLAFONIERA LED

NEW



VAND LED 17,5W NW W



VAND LED 17,5W NW B



Kanlux VAND LED est une version moderne du plafonnier traditionnel. Les éléments noirs ou blancs (selon le modèle choisi) ajoutent de l'élégance et une bouffée d'air frais. Kanlux VAND LED donne une lumière très subtile, de sorte que dans les grandes pièces, vous pouvez utiliser plusieurs de ces lampes ou les placer uniquement dans les zones où vous n'avez pas besoin d'un éclairage puissant.

Matériau du boîtier: métal

Matériau du diffuseur: matériau plastique

Kanlux VAND LED è un versione moderna di una plafoniera tradizionale. Elementi in bianco o nero (a seconda del modello scelto) aggiungono eleganza e leggerezza. Kanlux VAND LED produce una luce delicata ed è indicata in piccole medi ambienti dove può essere affiancata da un'illuminazione complementare.

Materiale del corpo: metallo

Diffusore: plastica



VAND LED 17,5W NW W	37326	5905339373267	17,5	LED	460	4000	blanc bianco
VAND LED 17,5W NW B	37327	5905339373274	17,5	LED	460	4000	noir nero

[V]	[Hz]	[°]	[h]	[h]	[lm]	Ra	Hg
220-240 AC	50	120	≥20000	25000	≤6x MacAdam	80	
SMD			IP 20		5+25		
1,5	0,5m	lm W 26	CE	ERL	UK CA		

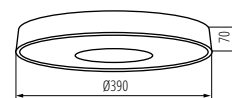

VAND LED 17,5W



RIFA LED 17,5W GR/G



Kanlux RIFA LED est un plafonnier unique. Il se distingue de ce type de luminaires par son abat-jour en tissu, qui le rend non seulement pratique mais surtout décoratif. Nous avons préparé 4 combinaisons de couleurs pour correspondre à votre intérieur, et vous pouvez choisir entre deux couleurs de lumière - neutre ou chaude. Kanlux RIFA LED est une solution idéale pour les pièces basses de plafond où l'on a besoin d'une lumière forte mais où l'on ne veut pas renoncer à son caractère décoratif.

Matériau du boîtier: métal

Matériau du diffuseur: matériau plastique

Kanlux RIFA LED è una lampada da soffitto unica. Si distingue dalle lampade tradizionali di questo tipo per un paralume materico, che la rende non solo pratica, ma soprattutto decorativa. Disponibile in 4 combinazioni di colori non incontrerà problemi ad abbinarsi ai tuoi interni. Kanlux RIFA LED è una soluzione ideale per ambienti bassi dove sarà necessaria una luce forte senza rinunciare al design.

Materiale del corpo: metallo

Diffusore: plastica

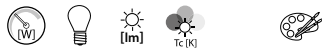

RIFA LED 17,5W NW/W/W	36460	5905339364609	17,5	LED	1500	4000	blanc bianco
RIFA LED 17,5W WW/W/W	36461	5905339364616	17,5	LED	1450	3000	blanc bianco
RIFA LED 17,5W NW B/W	36462	5905339364623	17,5	LED	1500	4000	noir / blanc nero / bianco
RIFA LED 17,5W WW B/W	36463	5905339364630	17,5	LED	1450	3000	noir / blanc nero / bianco
RIFA LED 17,5W NW B/G	36464	5905339364647	17,5	LED	1500	4000	noir / or nero / oro
RIFA LED 17,5W WW B/G	36465	5905339364654	17,5	LED	1450	3000	noir / or nero / oro
RIFA LED 17,5W NW GR/G	36466	5905339364661	17,5	LED	1500	4000	gris / or grigio / oro
RIFA LED 17,5W WW GR/G	36467	5905339364678	17,5	LED	1450	3000	gris / or grigio / oro
RIFA LED 17,5W NW N1	36468	5905339364685	17,5	LED	1500	4000	blanc bianco
RIFA LED 17,5W WW N1	36469	5905339364692	17,5	LED	1450	3000	blanc bianco
RIFA LED 17,5W NW N2	36508	5905339365088	17,5	LED	1500	4000	brun marrone
RIFA LED 17,5W WW N2	36509	5905339365095	17,5	LED	1450	3000	brun marrone

[V] 220-240 AC	[Hz] 50	[°] 120	[h] ≥20000	[h] 25000	ellipse ≤ 6x MacAdam	Ra 80	Hg	SMD
		IP 20	5+25			1,5	0,5m	
CE	ERC	UK CA						

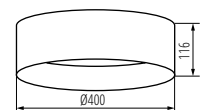

RIFA LED 17,5W

Kanlux

RIFA LED

PLAFONNIER LED ▶ PLAFONIERA LED



RIFA LED 17,5W W/W



RIFA LED 17,5W B/W



RIFA LED 17,5W B/G



RIFA LED 17,5W GR/G



RIFA LED 17,5W N1



RIFA LED 17,5W N2



Kanlux

ARVOS LED

PLAFONNIER LED ▶ PLAFONIERA LED

NEW



ARVOS LED 37W CCT B



ARVOS LED 37W CCT W



Kanlux ARVOS LED est un plafonnier qui vous permettra de changer l'ambiance d'une pièce sans avoir à changer de lampe. Grâce à la télécommande, vous pouvez facilement changer la couleur de la lumière et son intensité, et le soir, vous pouvez régler le mode nuit pour faciliter votre repos. Kanlux ARVOS LED est une lampe qui vous permet d'adapter la lumière de chaque pièce à chaque situation et à votre activité.

Matériau du boîtier: acier
Matériau du diffuseur: PMMA

Kanlux ARVOS LED è un plafoniera che permette di variare la temperatura di colore della luce (cct). Grazie al telecomando in dotazione potrete scegliere fra tonalità calde, neutre o fredde in base alle esigenze e agli ambienti in cui sarà installata

Materiale del corpo: metallo
Diffusore: PMMA



ARVOS LED 37W CCT B	37330	5905339373304	max 37	LED	max 2680 (4000K)	2700/4000/6500	noir nero
ARVOS LED 37W CCT W	37331	5905339373311	max 37	LED	max 2680 (4000K)	2700/4000/6500	blanc bianco

[V]	[Hz]	[°]	[lm]	[h]	[lm]	[Ra]
220-240 AC	50	120	≥15000	25000	≤6/Machdam	80
Hg	SMD	IP	20	5+25		
	DIMMING function	0,5m	infrared			

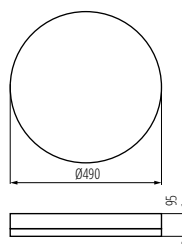

ARVOS

Kanlux

JASMIN W

LUMINAIRE MURAL ► LAMPADA DA PARETE



JASMIN G/O-W



JASMIN WE-W



JASMIN W-W



JASMIN W/M-W



JASMIN B-W



JASMIN WE-W	23756	5905339237569	max 20	E27	LED	wengé wengé
JASMIN W-W	23757	5905339237576	max 20	E27	LED	chêne blanc rovere bianco
JASMIN W/M-W	23758	5905339237583	max 20	E27	LED	blanc bianco
JASMIN B-W	29209	5905339292094	max 20	E27	LED	noir nero
JASMIN G/O-W	36443	5905339364432	max 20	E27	LED	chêne doré oro quercia

220-240 AC	50				IP 20	5+25	
1+1,5	0,5m						

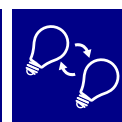

Les luminaires Kanlux JASMIN, soigneusement fabriqués en bois, offrent plusieurs possibilités d'aménager des espaces de manière efficace. Le boîtier impressionnant combiné au verre satiné qui assure une répartition lumineuse uniforme confère un caractère unique à chaque espace.

Matériau du boîtier: bois

Matériau du diffuseur: verre

Gli apparecchi a parete Kanlux JASMIN per l'accurata realizzazione il corpo disponibile in 4 colori in combinazione con il vetro satinato doneranno un carattere unico agli ambienti in cui sarà inserita.

Materiale del corpo: legno

Diffusore: vetro

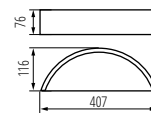

JASMIN

Kanlux JASMIN

PLAFONNIER ▶ PLAFONIERA



JASMIN 270-G/O



JASMIN 270-WE	23120	5905339231208	max 20	E27	LED	wengé wengé
JASMIN 370-WE	23121	5905339231215	2 x max 20	E27	LED	wengé wengé
JASMIN 470-WE	23122	5905339231222	3 x max 20	E27	LED	wengé wengé
JASMIN 270-W	23123	5905339231239	max 20	E27	LED	chêne sonoma quercia Sonoma
JASMIN 370-W	23124	5905339231246	2 x max 20	E27	LED	chêne sonoma quercia Sonoma
JASMIN 470-W	23125	5905339231253	3 x max 20	E27	LED	chêne sonoma quercia Sonoma
JASMIN 270-W/M	23126	5905339231260	max 20	E27	LED	blanc mat bianco opaco
JASMIN 370-W/M	23127	5905339231277	2 x max 20	E27	LED	blanc mat bianco opaco
JASMIN 470-W/M	23128	5905339231284	3 x max 20	E27	LED	blanc mat bianco opaco
JASMIN 470-B	29205	5905339292056	3 x max 20	E27	LED	noir nero
JASMIN 270-B	29207	5905339292070	max 20	E27	LED	noir nero
JASMIN 370-B	29208	5905339292087	2 x max 20	E27	LED	noir nero
JASMIN 270-G/O	36440	5905339364401	max 20	E27	LED	chêne doré oro quercia
JASMIN 370-G/O	36441	5905339364418	2 x max 20	E27	LED	chêne doré oro quercia
JASMIN 470-G/O	36442	5905339364425	3 x max 20	E27	LED	chêne doré oro quercia

[VI] 220-240 AC	[Hz] 50	[E]	IP 20	[H]	[T] 5+25	[M] 0,5m	[S]	[CE]	[EAC]	[UKA]	[C]
--------------------	------------	-----	----------	-----	-------------	-------------	-----	------	-------	-------	-----

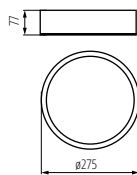

JASMIN 270

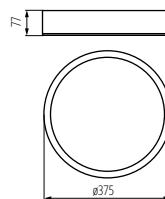

JASMIN 370

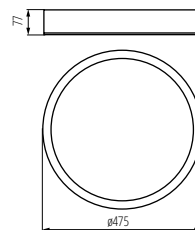

JASMIN 470

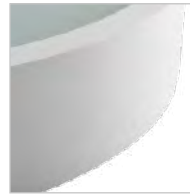

Les luminaires Kanlux JASMIN, arrondis, originaux et stylés se caractérisent par un design moderne et attrayant. Le boîtier du plafonnier est fabriqué en bois et en verre traité à l'acide (satiné) qui garantit une répartition lumineuse uniforme. La combinaison classique du bois et du verre en fait une solution d'éclairage très universelle.

Matériau du boîtier: bois
Matériau du diffuseur: verre

Gli apparecchi Kanlux JASMIN sono originali ma allo stesso tempo dotati di molta classe, si distinguono per il design moderno e accattivante. La cover della plafoniera e' realizzata in legno, il diffusore e' in vetro acidato (satinato) e garantisce una distribuzione uniforme della luce. Una combinazione classica di legno e vetro ne fa una soluzione illuminotecnica unica.

Materiale del corpo: legno
Diffusore: vetro

Kanlux
JASMIN

PLAFONNIER ► PLAFONIERA



JASMIN 270-G/O



JASMIN 370-G/O



JASMIN 470-G/O



JASMIN 270-WE



JASMIN 370-WE



JASMIN 470-WE



JASMIN 270-W



JASMIN 370-W



JASMIN 470-W



JASMIN 270-W/M



JASMIN 370-W/M



JASMIN 470-W/M



JASMIN 270-B



JASMIN 370-B



JASMIN 470-B

DERATO

LUMINAIRE MURAL ET PLAFONNIER ▶ LAMPADA DA PARETE-SOFFITTO



DERATO EL-10 B-SR



La nouvelle série de luminaires Kanlux DERATO fait référence dans sa forme au style RETRO. Ces lampes existent en deux couleurs : blanc et noir et ont de 1 à 4 points lumineux. Le Kanlux DERATO en version simple remplit également avec succès le rôle d'une applique. Les grands abat-jour de ces luminaires offrent également de nombreuses possibilités d'utilisation de diverses sources lumineuses avec un culot E14 (max.8W). Les luminaires Kanlux DERATO utilisent un connecteur rapide pour un montage pratique et facile. Un autre avantage est la possibilité de diriger l'abat-jour vers n'importe quelle direction (deux axes de rotation: 350 et 110 degrés).

Matériau du boîtier: alliage en aluminium

La nuova serie di apparecchi Kanlux DERATO ricorda lo stile RETRO. Si tratta di lampade in due colori: bianco e nero, da 1 a 4 punti luce. Le lampade con un singolo punto luce sono adatte anche come lampade da parete. Dotate di grandi paralumi hanno un attacco E14 (max 8W). Gli apparecchi Kanlux DERATO utilizzano un cablaggio rapido per un'installazione comoda e sicura. Un ulteriore vantaggio è la possibilità di orientare il paralume in qualsiasi direzione (due assi di rotazione: 350 e 110 gradi).

Materiale del corpo: alluminio



DERATO EL-10 B-SR	35640	5905339356406	max 8	noir / argent nero / argento
DERATO EL-10 W-SR	35641	5905339356413	max 8	blanc / argent bianco / argento
DERATO EL-21 B-SR	35642	5905339356420	2x max 8	noir / argent nero / argento
DERATO EL-21 W-SR	35643	5905339356437	2x max 8	blanc / argent bianco / argento
DERATO EL-30 B-SR	35644	5905339356444	3x max 8	noir / argent nero / argento
DERATO EL-30 W-SR	35645	5905339356451	3x max 8	blanc / argent bianco / argento
DERATO EL-41 B-SR	35646	5905339356468	4x max 8	noir / argent nero / argento
DERATO EL-41 W-SR	35647	5905339356475	4x max 8	blanc / argent bianco / argento

[V] 220-240 AC	[Hz] 50				IP 20			
				CE	EAC	UK		
350	110	0,5m						

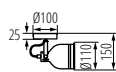

DERATO EL-10

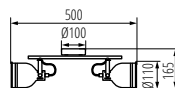

DERATO EL-21

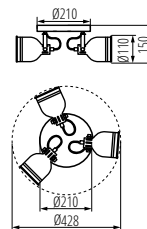

DERATO EL-30

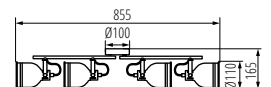

DERATO EL-41

Kanlux

DERATO

LUMINAIRE MURAL ET PLAFONNIER ► LAMPADA DA PARETE-SOFFITTO



DERATO EL-10 B-SR



DERATO EL-10 W-SR



DERATO EL-2I B-SR



DERATO EL-2I W-SR



DERATO EL-30 B-SR



DERATO EL-30 W-SR



DERATO EL-4I B-SR



DERATO EL-4I W-SR



Kanlux EVALO

LUMINAIRE MURAL ET PLAFONNIER ▶ LAMPADA DA PARETE-SOFFITTO



EVALO EL-11 B-SR



EVALO EL-2I W-SR	35692	5905339356925	2 x max 10	blanc bianco
EVALO EL-2I B-SR	35693	5905339356932	2 x max 10	noir nero
EVALO EL-3I W-SR	35694	5905339356949	3 x max 10	blanc bianco
EVALO EL-3I B-SR	35695	5905339356956	3 x max 10	noir nero
EVALO EL-4O W-SR	35696	5905339356963	4 x max 10	blanc bianco
EVALO EL-4O B-SR	35697	5905339356970	4 x max 10	noir nero
EVALO EL-4I W-SR	35698	5905339356987	4 x max 10	blanc bianco
EVALO EL-4I B-SR	35699	5905339356994	4 x max 10	noir nero
EVALO EL-5I W-SR	35688	5905339356888	5 x max 10	blanc bianco
EVALO EL-5I B-SR	35689	5905339356895	5 x max 10	noir nero
EVALO EL-11 W-SR	35690	5905339356901	max 10	blanc bianco
EVALO EL-11 B-SR	35691	5905339356918	max 10	noir nero

[V] 220-240 AC	[Hz] 50		PAR16	GU10		IP 20	
5+25	320	90	1+2,5	0,5m			

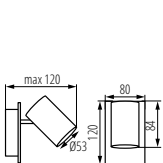

EVALO EL-11

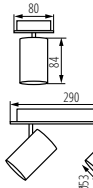

EVALO EL-2I

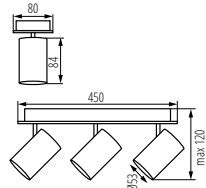

EVALO EL-3I

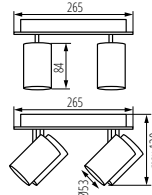

EVALO EL-4O

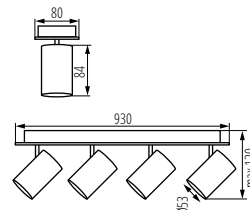

EVALO EL-4I

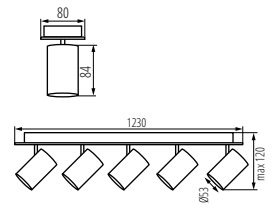

EVALO EL-5I



Kanlux EVALO est une gamme de spots simples. Avec sa sobriété scandinave et ses éléments argentés, c'est un classique très élégant. L'abat-jour étroit convient aux sources GU10 (une ventouse est incluse pour une installation facile). Les deux couleurs (noir et blanc) et le nombre de 1 à 5 points lumineux de ces luminaires ouvrent de nombreuses possibilités d'utilisation. Spot simple Kanlux EVALO est une applique idéale au-dessus d'un bureau, d'un lit ou derrière un canapé. Grâce à cette disposition, le Kanlux EVALO peut servir à la fois de lumière principale et de lumière d'appoint. Un avantage supplémentaire est la possibilité de régler la direction de la lumière (deux axes de rotation: 320 et 90 degrés).

Matériau du boîtier: alliage en aluminium

Kanlux EVALO è una famiglia di faretto spot dal design lineare. Semplicità scandinava e elementi argento connotano questi prodotti. Il diffusore stretto e lungo ospita una lampade GU10 (nel set è compresa una ventosa per facilitarne l'installazione). Disponibili in due colori (bianco e nero) e con un numero di punti luce da 1 a 5. Questi faretto sono compatibili con gli ambienti più eterogenei. Il modello con un punto luce singolo è va bene per le scrivanie e per i comodi. Kanlux EVALO può fungere da luce principale o complementare. Un ulteriore vantaggio è la possibilità di orientare la luce su due assi. Con un angolo sull'asse orizzontale di 320° e verticalmente di 90°.

Materiale del corpo: alluminio

Kanlux

EVALO

LUMINAIRE MURAL ET PLAFONNIER ► LAMPADA DA PARETE-SOFFITTO



EVALO EL-11 W-SR



EVALO EL-21 B-SR



EVALO EL-21 W-SR



EVALO EL-31 B-SR



EVALO EL-31 W-SR



EVALO EL-40 B-SR



EVALO EL-40 W-SR



EVALO EL-41 B-SR



EVALO EL-41 W-SR



EVALO EL-51 B-SR



EVALO EL-51 W-SR



SONDA II

LUMINAIRE MURAL ET PLAFONNIER ▶ LAMPADA DA PARETE-SOFFITTO



SONDA II EL-10 B



SONDA II EL-10 B	34920	5905339349200	max 10	noir nero
SONDA II EL-10 W	34921	5905339349217	max 10	blanc bianco
SONDA II EL-21 B	34922	5905339349224	2 x max 10	noir nero
SONDA II EL-21 W	34923	5905339349231	2 x max 10	blanc bianco
SONDA II EL-31 B	34924	5905339349248	3 x max 10	noir nero
SONDA II EL-31 W	34925	5905339349255	3 x max 10	blanc bianco
SONDA II EL-30 B	34926	5905339349262	3 x max 10	noir nero
SONDA II EL-30 W	34927	5905339349279	3 x max 10	blanc bianco
SONDA II EL-40 B	34928	5905339349286	4 x max 10	noir nero
SONDA II EL-40 W	34929	5905339349293	4 x max 10	blanc bianco

[V] 220-240 AC	[Hz] 50	 PAR16	 GU10	 IP 20	
 5+25	 330	 120	 1+2,5	 0,5m	

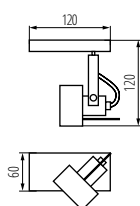

SONDA II EL-10

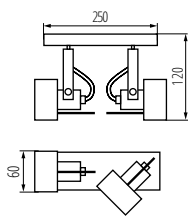

SONDA II EL-21

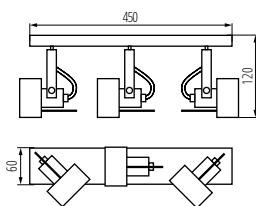

SONDA II EL-31

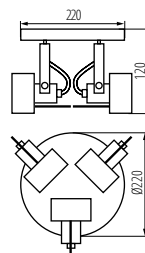

SONDA II EL-30

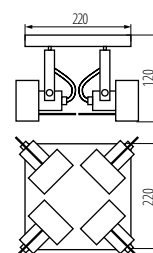

SONDA II EL-40



Kanlux SONDA II est une gamme de lampes modernes dans laquelle vous pouvez choisir de 1 à 4 points de lumière. La forme moderne de ces luminaires constitueront une décoration unique de tout intérieur. Un avantage supplémentaire des lampes Kanlux SONDA est la finition extrêmement élégante de l'abat-jour qui cache les bords de la source lumineuse, de sorte que seule la lentille de l'ampoule est visible.

Matériau du boîtier: alliage en aluminium

Kanlux SONDA II è una moderna serie di lampade disponibili da 1 a 4 punti luce. La forma moderna di questi prodotti si adatta facilmente agli ambienti più diversi. Un'ulteriore caratteristica delle lampade Kanlux SONDA II è una finitura eccezionalmente elegante del diffusore, che nasconde i bordi della lampadina.

Materiale del corpo: alluminio

Kanlux

SONDA II

LUMINAIRE MURAL ET PLAFONNIER ► LAMPADA DA PARETE-SOFFITTO



SONDA II EL-10 W



SONDA II EL-21 B



SONDA II EL-21 W



SONDA II EL-31 B



SONDA II EL-31 W



SONDA II EL-30 B



SONDA II EL-30 W



SONDA II EL-40 B



SONDA II EL-40 W





GALOBA EL-10 W



GALOBA EL-10 W	33670	5905339336705	max 35	blanc bianco
GALOBA EL-10 B	33671	5905339336712	max 35	noir nero
GALOBA EL-2I W	33674	5905339336743	2 x max 35	blanc bianco
GALOBA EL-2I B	33675	5905339336750	2 x max 35	noir nero
GALOBA EL-3I W	33676	5905339336767	3 x max 35	blanc bianco
GALOBA EL-3I B	33677	5905339336774	3 x max 35	noir nero
GALOBA EL-4I W	33678	5905339336781	4 x max 35	blanc bianco
GALOBA EL-4I B	33679	5905339336798	4 x max 35	noir nero
GALOBA EL-4I W	33680	5905339336804	4 x max 35	blanc bianco
GALOBA EL-4I B	33681	5905339336811	4 x max 35	noir nero

[V] 220-240 AC	[Hz] 50				IP 20	
5+25	335	315	0,75+1,5	0,5m		
ERC	UK CA					

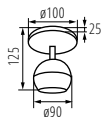

GALOBA EL-10

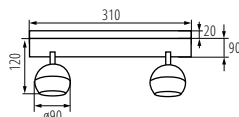

GALOBA EL-2I

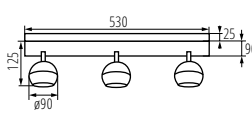

GALOBA EL-3I

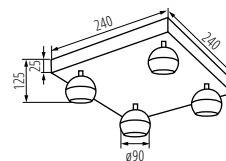

GALOBA EL-4I

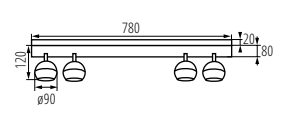

GALOBA EL-4I



Kanlux GALOBA est une gamme complète de luminaires, comprenant les suspensions (GALOBA C), les appliques murales (GALOBA W) et les accessoires de fixation pour murs et plafonds. Les suspensions GALOBA C de Kanlux peuvent être utilisées pour l'éclairage d'îlots ou de tables, tandis que les appliques et les plafonniers (de 1 à 4 points de lumière) peuvent être utilisés dans un salon, un hall ou une chambre. L'arrangement peut être complété par des appliques murales avec l'interrupteur dans le socle. Tous les luminaires de la gamme GALOBA sont équipés d'un abat-jour amovible grâce auquel les sources lumineuses peuvent être rapidement et confortablement remplacées. La hauteur maximale de la source lumineuse des luminaires GALOBA est de 55 mm. Nous recommandons les lampes Kanlux SMART (S GU10) ou iQ-LED LIFE (iQ LED L GU10).

Hauteur maximale de la source lumineuse 55mm

Matériau du boîtier: alliage en aluminium

Kanlux GALOBA è una famiglia di faretti che include lampade a sospensione (GALOBA C), lampade da parete (GALOBA W) e lampade da soffitto. Possono essere facilmente utilizzate per illuminare tavoli o isole della cucina. Le lampade da parete (con 1 o 4 punti luce) sono adatte ad ambienti come il soggiorno o la camera da letto. I modelli da parete sono dotati di un interruttore posto alla base. La gamma GALOBA permette una facile e immediata sostituzione della lampadina.

Altezza massima della sorgente luminosa 55 mm

Maximální výška světelného zdroje 55 mm

Materiale del corpo: alluminio

Kanlux

GALOBA

LUMINAIRE MURAL ET PLAFONNIER ▶ LAMPADA DA PARETE-SOFFITTO



GALOBA EL-10 B



GALOBA EL-21 W



GALOBA EL-21 B



GALOBA EL-31 W



GALOBA EL-31 B



GALOBA EL-40 W



GALOBA EL-40 B



GALOBA EL-41 W



GALOBA EL-41 B



LAURIN

LUMINAIRE MURAL ET PLAFONNIER ▶ LAMPADA DA PARETE-SOFFITTO



LAURIN EL-10 B



GALOBA EL-10 W	33670	5905339336705	max 35	blanc bianco
GALOBA EL-10 B	33671	5905339336712	max 35	noir nero
GALOBA EL-2I W	33674	5905339336743	2 x max 35	blanc bianco
GALOBA EL-2I B	33675	5905339336750	2 x max 35	noir nero
GALOBA EL-3I W	33676	5905339336767	3 x max 35	blanc bianco
GALOBA EL-3I B	33677	5905339336774	3 x max 35	noir nero
GALOBA EL-4I W	33678	5905339336781	4 x max 35	blanc bianco
GALOBA EL-4I B	33679	5905339336798	4 x max 35	noir nero
GALOBA EL-4I W	33680	5905339336804	4 x max 35	blanc bianco
GALOBA EL-4I B	33681	5905339336811	4 x max 35	noir nero

[V] 220-240 AC	[Hz] 50				IP 20	
5+25	310	90	1+2,5	0,5m		

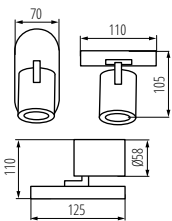

LAURIN EL-10

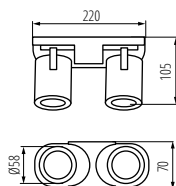

LAURIN EL-2I

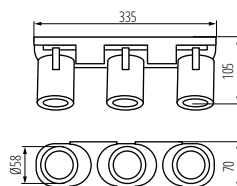

LAURIN EL-3I

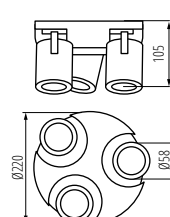

LAURIN EL-30

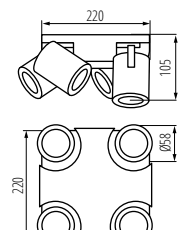

LAURIN EL-40



Les spots Kanlux LAURIN fournissent un très grand choix de spots orientables en appliques et plafonniers. Le design simple et minimaliste peut être utilisé avec succès dans de nombreuses pièces de la maison. Le choix de la direction du faisceau lumineux est un avantage supplémentaire qu'offrent ces luminaires.

Matériau du boîtier: alliage en aluminium

La famiglia Kanlux LAURIN è ampia. Il design semplice ed essenziale ne permette un utilizzo in ambienti diversi. Si tratta di prodotti orientabili a uno, due, tre o quattro punti luce.

Enclosure material: aluminum alloy

Kanlux

LAURIN

LUMINAIRE MURAL ET PLAFONNIER ► LAMPADA DA PARETE-SOFFITTO



LAURIN EL-10 W



LAURIN EL-21 W



LAURIN EL-21 B



LAURIN EL-31 W



LAURIN EL-31 B

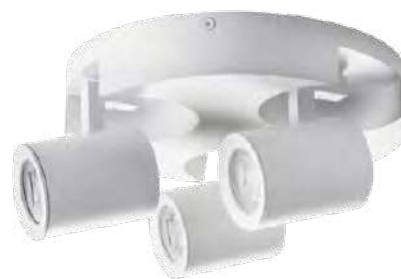

LAURIN EL-30 W



LAURIN EL-30 B



LAURIN EL-40 W



LAURIN EL-40 B



SEMPRA

LUMINAIRE MURAL ET PLAFONNIER ▶ LAMPADA DA PARETE-SOFFITTO



SEMPRA EL-11 B-SR



SEMPRA EL-11 W-SR	33090	5905339330901	max 10	blanc bianco
SEMPRA EL-11 B-SR	33091	5905339330918	max 10	noir nero
SEMPRA EL-21 W-SR	33092	5905339330925	2 x max 10	blanc bianco
SEMPRA EL-21 B-SR	33093	5905339330932	2 x max 10	noir nero
SEMPRA EL-31 W-SR	33094	5905339330949	3 x max 10	blanc bianco
SEMPRA EL-31 B-SR	33095	5905339330956	3 x max 10	noir nero
SEMPRA EL-41 W-SR	33096	5905339330963	4 x max 10	blanc bianco
SEMPRA EL-41 B-SR	33097	5905339330970	4 x max 10	noir nero

[V] 220-240 AC	[Hz] 50										



SEMPRA EL-11

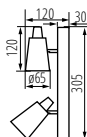

SEMPRA EL-21

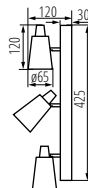

SEMPRA EL-31

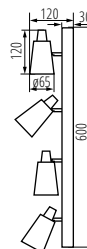

SEMPRA EL-41



Kanlux SEMPRA est une série de spots élégants en noir et blanc ou en noir et argent. Grâce à la patère sur laquelle les luminaires sont montés, tous les modèles sont parfaitement adaptés à la fixation plafond ou la fixation murale -cela donne la possibilité d'agencer l'éclairage dans une pièce donnée. Il est intéressant de noter la possibilité de monter jusqu'à quatre spots en version applique murale.

Matériau du boîtier: acier

Kanlux SEMPRA è una serie di eleganti spot in bianco-argento e nero-argento. La disposizione orizzontale di questi faretti li rende compatibili con un utilizzo a soffitto o a parete.

Materiale del corpo: metallo

Kanlux

SEMPRA

LUMINAIRE MURAL ET PLAFONNIER ► LAMPADA DA PARETE-SOFFITTO



SEMPPRA EL-11 W-SR



SEMPPRA EL-21 W-SR



SEMPPRA EL-21 B-SR



SEMPPRA EL-31 W-SR



SEMPPRA EL-31 B-SR



SEMPPRA EL-41 W-SR



SEMPPRA EL-41 B-SR





ENALI EL-10 W



ENALI EL-10 W	28760	5905339287601	max 10	blanc bianco
ENALI EL-10 B	28761	5905339287618	max 10	noir nero
ENALI EL-21 W	28762	5905339287625	2 x max 10	blanc bianco
ENALI EL-21 B	28763	5905339287632	2 x max 10	noir nero
ENALI EL-30 W	28764	5905339287649	3 x max 10	blanc bianco
ENALI EL-30 B	28765	5905339287656	3 x max 10	noir nero
ENALI EL-31 W	28766	5905339287663	3 x max 10	blanc bianco
ENALI EL-31 B	28767	5905339287670	3 x max 10	noir nero
ENALI EL-41 W	28768	5905339287687	4 x max 10	blanc bianco
ENALI EL-41 B	28769	5905339287694	4 x max 10	noir nero

[V] 220-240 AC	[Hz] 50					

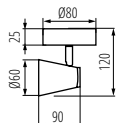

ENALI EL-10

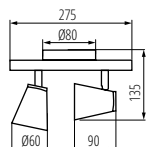

ENALI EL-21

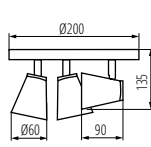

ENALI EL-30

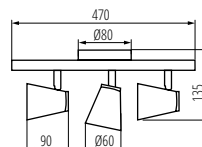

ENALI EL-31

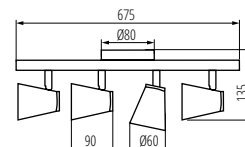

ENALI EL-41



Kanlux ENALI est série de luminaires plafonniers (pour plafond et mur). Grâce à l'articulation réglable, il est possible de diriger librement le faisceau lumineux. Les luminaires s'intègrent parfaitement dans les intérieurs de style scandinave, leurs formes rappellent le caractère rétro des intérieurs et leurs éléments chromés apportent une touche subtile aux intérieurs modernes.

Matériau du boîtier: acier
Matériau du diffuseur: acier

Kanlux ENALI è una famiglia di faretti orientabili (da soffitto e parete). Grazie ai giunti regolabili si può impostare liberamente l'angolo d'incidenza della luce. Questi faretti si abbinano perfettamente agli interni in stile scandinavo, la loro forma enfatizzerà il carattere degli interni retrò e gli accessori cromati aggiungeranno un tocco di raffinatezza agli interni moderni.

Materiale del corpo: metallo
Diffusore: metallo

Kanlux

ENALI

LUMINAIRE MURAL ET PLAFONNIER ► LAMPADA DA PARETE-SOFFITTO



ENALI EL-10 B



ENALI EL-21 W



ENALI EL-21 B



ENALI EL-30 W



ENALI EL-30 B



ENALI EL-31 W



ENALI EL-31 B



ENALI EL-41 W



ENALI EL-41 B



MILENO

LUMINAIRE MURAL ET PLAFONNIER ▶ LAMPADA DA PARETE-SOFFITTO



MILENO EL-10 B-AG



MILENO EL-10 B-AG	29110	5905339291103	max 10	noir / or	nero / oro
MILENO EL-10 ASR-AN	29111	5905339291110	max 10	argent / cuivre	argento / ramato
MILENO EL-30 B-AG	29112	5905339291127	3 x max 10	noir / or	nero / oro
MILENO EL-30 ASR-AN	29113	5905339291134	3 x max 10	argent / cuivre	argento / ramato
MILENO EL-2I B-AG	29114	5905339291141	2 x max 10	noir / or	nero / oro
MILENO EL-2I ASR-AN	29115	5905339291158	2 x max 10	argent / cuivre	argento / ramato
MILENO EL-3I B-AG	29116	5905339291165	3 x max 10	noir / or	nero / oro
MILENO EL-3I ASR-AN	29117	5905339291172	3 x max 10	argent / cuivre	argento / ramato
MILENO EL-4I B-AG	29118	5905339291189	4 x max 10	noir / or	nero / oro
MILENO EL-4I ASR-AN	29119	5905339291196	4 x max 10	argent / cuivre	argento / ramato

[V] 220-240 AC	[Hz] 50					IP 20	
 5=25	 300	 80	 1+2,5	 0,5m			

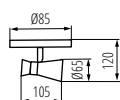

MILENO EL-10

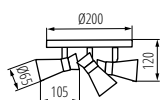

MILENO EL-30

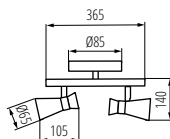

MILENO EL-2I

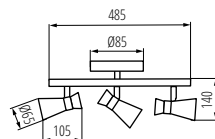

MILENO EL-3I

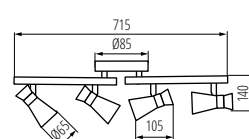

MILENO EL-4I



Kanlux MILENO est une réponse aux nouvelles tendances. Design soigné et formes originales sont les avantages de cette série. Le très grand nombre de modèles de luminaires Kanlux MILENO donne de très nombreuses possibilités d'agencement.

Matériau du boîtier: acier

Kanlux MILENO risponde alle ultime tendenze. Un design interessante e una forma originale sono i vantaggi di questa serie. Disponibili in diverse combinazioni di forma e colore.

Materiale del corpo: metallo

Kanlux

MILENO

LUMINAIRE MURAL ET PLAFONNIER ► LAMPADA DA PARETE-SOFFITTO



MILENO EL-10 ASR-AN



MILENO EL-21 B-AG



MILENO EL-21 ASR-AN



MILENO EL-30 B-AG



MILENO EL-30 ASR-AN



MILENO EL-31 B-AG



MILENO EL-31 ASR-AN



MILENO EL-41 B-AG



MILENO EL-41 ASR-AN



Kanlux

BOLA LED

VEILLEUSE LED ► LAMPADA A LED PLUG-IN

NEW



BOLA LED 2xUSB WW W



Kanlux BOLA LED est une lampe LED enfichable dotée de deux ports USB (A et C). La lampe peut fonctionner dans l'un des trois modes suivants : ON - allumage permanent/OFF - extinction permanente/AUTO - allumage à faible intensité lumineuse (la lampe est dotée d'un capteur crépusculaire). Grâce aux ports USB, la lampe peut également servir de chargeur pour les appareils mobiles. Kanlux BOLA émet une lumière nocturne douce (4 lumens) à une température blanche chaude.

Matériau du boîtier: PC
Matériau du diffuseur: PC

Kanlux BOLA LED è una lampada LED plug-in con due porte USB (A e C). La lampada può funzionare in tre modalità - ON - permanentemente on/OFF - permanentemente off/AUTO - si accende a bassa intensità luminosa (la lampada ha un sensore crepuscolare). Grazie alle porte USB, la lampada può funzionare anche come caricabatterie per dispositivi mobili. Kanlux BOLA emette luce notturna di "cortesia" (4 lumen) in un bianco caldo.

Materiale del corpo: PC
Diffusore: PC



BOLA LED 2xUSB WW W | 37397 | 5905339373977 | max 15 | 4 (0,22W) | 3000 | blanc | bianco

[V] 220-240 AC	[Hz] 50	15000	ellipso ≤ 6x MacAdam	Hg	SMD		
IP 20			CE	ERAC	UK CA		

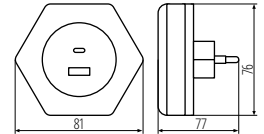

BOLA LED 2xUSB WW W

Kanlux

ULOV LED

VEILLEUSE LED ► LAMPADA A LED PLUG-IN

NEW



ULOV LED DIM WW W



Kanlux ULOV LED est une lampe enfichable dont l'intensité lumineuse peut être réglée en continu. Elle est dotée d'un capteur de crépuscularité intégré (qui allume et éteint automatiquement la lumière). Son design convivial permet de la placer dans les prises de courant des chambres à coucher, des chambres d'enfants, des chambres de personnes âgées ou dans les couloirs.

Matériau du boîtier: matériau plastique
Matériau du diffuseur: matériau plastique

Kanlux ULOV LED è una lampada plug-in in cui l'intensità della luce può essere regolata a piacere. Ha un sensore crepuscolare incorporato (accende e spegne automaticamente la luce). Ideale per le in camera da letto, camere dei bambini, per anziani o nei corridoi.

Materiale del corpo: plastica
Diffusore: plastica



ULOV LED DIM WW W | 37396 | 5905339373960 | 0,5 | 1-30 | 3000 | blanc | bianco

[V] 220-240 AC	[Hz] 50	ellipso ≤ 6x MacAdam	Hg	SMD			
IP 20			CE	ERAC	UK CA		

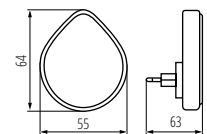

ULOV LED DIM WW W

Kanlux ORISA LED

VEILLEUSE LED ► LAMPADA A LED PLUG-IN

NEW



ORISA LED WW W

ORISA LED WW B

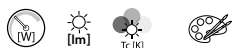

ORISA LED WW W	37394	5905339373946	0,28	5	3000	blanc bianco
ORISA LED WW B	37395	5905339373953	0,28	5	3000	noir nero

[V] 220-240 AC	[Hz] 50	ellipso ≤ 60° Maxdäm	Hg	SMD		
IP 20	house icon	lm W 18	CE	ErC	UK CA	



Kanlux ORISA LED est une lampe enfichable. Elle est dotée d'un capteur de crépuscularité intégré (qui allume et éteint automatiquement la lumière). Son design convivial permet de la placer dans les prises de courant des chambres à coucher, des chambres d'enfants, des chambres de personnes âgées ou dans les couloirs.

Matériau du boîtier: PC

Kanlux ORISA LED è una lampada plug-in elegante con un sensore crepuscolare integrato (accensione e spegnimento automatico a seconda della luminosità dell'ambiente). È ideale per le camere da letto, quelle dei bambini o nei corridoi. La lampada emette luce delicata (5 lumen), e il suo design elegante sarà una decorazione aggiuntiva del luogo che la ospiterà.

Materiale del corpo: PC

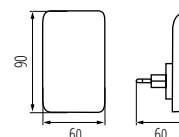

ORISA LED WW

Kanlux HOFI LED

VEILLEUSE LED ► LAMPADA A LED PLUG-IN

NEW



HOFI LED WW W

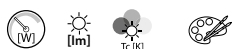

HOFI LED WW W	37393	5905339373939	0,28	2	3000	blanc bianco
---------------	--------------	---------------	------	---	------	----------------

[V] 220-240 AC	[Hz] 50	ellipso ≤ 60° Maxdäm	Hg	SMD		
IP 20	house icon	lm W 7	CE	ErC	UK CA	



Kanlux HOFI LED est une lampe enfichable dotée d'un capteur crépusculaire, qui peut être placée dans des prises près des escaliers, dans les couloirs, les chambres à coucher et les chambres d'enfants. La puissance lumineuse de la lampe est de 2 lumens (lumière très douce), et elle peut être branchée dans la prise de courant de deux façons, de sorte que la lumière tombe vers le bas ou vers le haut.

Matériau du boîtier: PC

Matériau du diffuseur: PC

Kanlux HOFI LED è una lampada plug-in con un sensore crepuscolare integrato, adatta vicino alle scale, nei corridoi, nelle camere da letto e nelle camere dei bambini. Il flusso luminoso della lampada è 2 lumen (luce molto tenue), è possibile collegarlo alla presa in due modi: con emissione della luce verso il soffitto oppure verso il pavimento.

Materiale del corpo: PC

Diffusore: PC

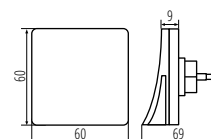

HOFI LED WW W

Kanlux

CALIZA LED

LUMINAIRE MURAL LED ▶ LAMPADA DA PARETE LED

NEW



CALIZA LED CCT W

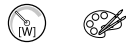
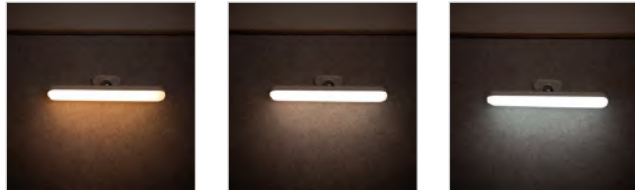

CALIZA LED CCT W | 37390 | 5905339373908 max 2 blanc | bianco



Kanlux CALIZIA LED est une applique moderne avec un flux lumineux de 160 lm, qui se recharge via USB C (câble de 220 mm de long inclus). Vous pouvez fixer la base de l'applique sur un mur ou une armoire à l'aide de ruban adhésif ou de 2 vis (incluses dans le kit), et vous pouvez facilement détacher la partie lumineuse elle-même (support magnétique) pour la recharger. Une fonction utile de l'applique Kanlux CALIZIA LED est la possibilité de changer l'intensité et la couleur de la lumière. Kanlux CALIZIA LED vous sera utile dans les endroits où vous n'avez pas d'installation à l'extérieur, comme lampe de meuble ou lampe portable. La lampe a une autonomie de fonctionnement de 5h.

Matériau du boîtier: matériau plastique

Matériau du diffuseur: matériau plastique

Kanlux CALIZIA LED è una lampada da parete moderna con un flusso luminoso di 160 lm. Viene caricata tramite USB C (il set include un cavo da 220 mm). Il supporto magnetico può essere ancorato alle pareti o negli armadi tramite due 2 viti (incluso nel set), la lampada si sgancia per una facile ricarica. Kanlux CALIZIA LED permette di cambiare il colore della luce da calda a neutra o fredda. Il tempo di funzionamento della lampada è di 5 ore consecutivamente accesa.

Materiale del corpo: plastica

Diffusore: plastica

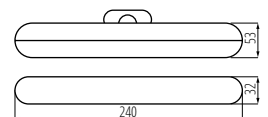

CALIZA LED CCT W

Kanlux GALOBA W

LUMINAIRE MURAL ► LAMPADA DA PARETE

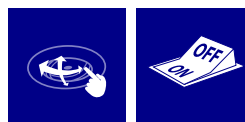

GALOBA W 1xGU10 B



GALOBA W 1xGU10 W

Kanlux GALOBA est une gamme complète de luminaires, comprenant les suspensions (GALOBA C), les appliques murales (GALOBA W) et les accessoires de fixation pour murs et plafonds. Les suspensions GALOBA C de Kanlux peuvent être utilisées pour l'éclairage d'îlots ou de tables, tandis que les appliques et les plafonniers (de 1 à 4 points de lumière) peuvent être utilisés dans un salon, un hall ou une chambre. L'arrangement peut être complété par des appliques murales avec l'interrupteur dans le socle. Tous les luminaires de la gamme GALOBA sont équipés d'un abat-jour amovible grâce auquel les sources lumineuses peuvent être rapidement et confortablement remplacées.

Hauteur maximale de la source lumineuse 55mm

Matériau du boîtier: alliage en aluminium

Kanlux GALOBA è una famiglia di faretto che include lampade a sospensione (GALOBA C), lampade da parete (GALOBA W) e lampade da soffitto. Possono essere facilmente utilizzate per illuminare tavoli o isole della cucina. Le lampade da parete (con 1 o 4 punti luce) sono adatte ad ambienti come il soggiorno o la camera da letto. I modelli da parete sono dotati di un interruttore posto alla base. La gamma GALOBA permette una facile e immediata sostituzione della lampadina.

Altezza massima della sorgente luminosa 55 mm
Maximální výška světelného zdroje 55 mm

Materiale del corpo: alluminio



GALOBA W 1xGU10 W	33672	5905339336729	max 35	blanc bianco
GALOBA W 1xGU10 B	33673	5905339336736	max 35	noir nero

[V]	[Hz]	PAR16	GU10	IP	20	5+25	335	315	0,75x1,5	0,5m	CE	EAC	UK CA
220-240 AC	50												

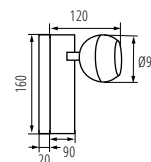

GALOBA W

Kanlux TONIL II LED

LUMINAIRE MURAL LED ► LAMPADA DA PARETE LED



TONIL II LED B



TONIL II LED W



Kanlux TONIL LED II est une applique de forme sobre avec une source de lumière intégrée. Son bras flexible en caoutchouc permet d'orienter l'éclairage dans la direction souhaitée. En même temps, nous pouvons lui donner la forme souhaitée.

Matériau du boîtier: alliage en aluminium

Matériau du diffuseur: matériau plastique

Kanlux TONIL LED II è un'elegante lampada da parete con led integrato. Il suo braccio flessibile in gomma consente di orientare l'illuminazione nella direzione desiderata. Allo stesso tempo, possiamo darle la forma desiderata.

Materiale del corpo: alluminio

Diffusore: plastica



TONIL II LED B	32522	5905339325228	3,3	noir nero
TONIL II LED W	32523	5905339325235	3,3	blanc bianco

[V]	[Hz]	[lm]	[°]	[h]	Tc [K]	≤ 60 Macadam	Ra	SMD	IP	20
220-240 AC	50	145	30	≥15000	20000	3000	80			
5+25	360	360	0,5-1,5	0,2m	Im W 44					

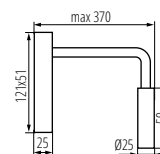

TONIL II LED

Kanlux

AGZAR EL

LUMINAIRE MURAL ET PLAFONNIER ▶ LAMPADA DA PARETE-SOFFITTO



AGZAR EL-10 B

AGZAR EL-10 W

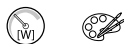

AGZAR EL-10 B	36254	5905339362544	max 5	noir nero
AGZAR EL-10 W	36255	5905339362551	max 5	blanc bianco

[V]	[Hz]						
220-240 AC	50	E14		IP 20		5÷25	
345	105		1+2,5				

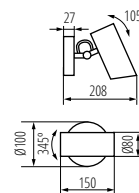

AGZAR EL 10

Kanlux

AGZAR E14

LAMPE DE TABLE ▶ LAMPADA DA TAVOLO



AGZAR E14 B

AGZAR E14 W

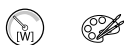

AGZAR E14 B	36250	5905339362506	max 5	noir nero
AGZAR E14 W	36251	5905339362513	max 5	blanc bianco

[V]	[Hz]							
220-240 AC	50	E14		IP 20		5÷25		180
180			1,45					

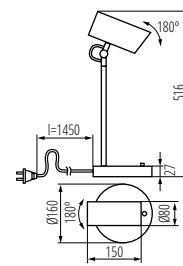

AGZAR E14



HIGH
quality
finish

DESIGN
unique

Kanlux AGZAR EL est une applique en acier. Le grand avantage de ces luminaires, outre leur design moderne, est la possibilité de faire pivoter l'abat-jour. Kanlux AGZAR EL est adaptée à une source lumineuse avec un culot E14 et une puissance maximale de 5W.

Matériau du boîtier: acier

Kanlux AGZAR EL è un faretto con un singolo punto luce realizzato interamente in metallo dal design elegante e moderno. Un indubbio vantaggio di questo prodotto è la possibilità di orientarlo a piacere in tutte le direzioni. I cavi sono intrecciati e la lampada è realizzata con cura in ogni dettaglio. Ha un attacco E14 e potenza massima di 5W

Materiale del corpo: metallo

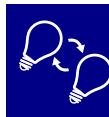

HIGH
quality
finish

DESIGN
unique

Kanlux AGZAR E14 est une lampe de table en acier. Son atout est la possibilité de faire pivoter l'abat-jour. La lampe est fabriquée avec soin et est équipée de câbles tressés. AGZAR E14 est adaptée à une source lumineuse avec un culot E14 et une puissance maximale de 5W. C'est une lampe qui ravira les amateurs de styles classique et modernes. L'attention portée à chaque détail et la structure en acier font de cette lampe un produit de classe PREMIUM.

Matériau du boîtier: acier

La lampada da tavolo Kanlux AGZAR E14 è realizzata interamente in metallo. Un indubbio vantaggio di questo prodotto è la possibilità di orientarlo a piacere in tutte le direzioni. I cavi sono intrecciati e la lampada è realizzata con cura in ogni dettaglio. (con attacco E14 e potenza massima di 5W) È una lampada che delizierà gli amanti dello stile classico e moderno con il suo design unico. La cura di ogni dettaglio e la struttura in metallo fanno di questa lampada un prodotto di classe PREMIUM.

Materiale del corpo: metallo

Kanlux

LARATA EL

LUMINAIRE MURAL ET PLAFONNIER ► LAMPADA DA PARETE-SOFFITTO



LARATA EL-10 W

LARATA EL-10 B

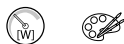

LARATA EL-10 W	36262	5905339362629	max 5	blanc bianco
LARATA EL-10 B	36263	5905339362636	max 5	noir nero

[V]	[Hz]						
220-240 AC	50	E27		IP 20			
330	100	1+2,5	0,5m				

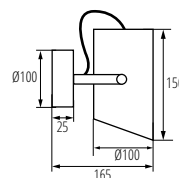

LARATA EL-10

Kanlux

LARATA E27

LAMPE DE TABLE ► LAMPADA DA TAVOLO



LARATA E27 W

LARATA E27 B



LARATA E27 W	36260	5905339362605	max 5	blanc bianco
LARATA E27 B	36261	5905339362612	max 5	noir nero

[V]	[Hz]						
220-240 AC	50	E27		IP 20			
110		1,5	0,1m				

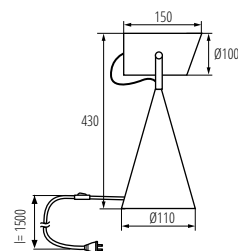

LARATA E27



HIGH
quality
finish

DESIGN
unique

Kanlux LARATA EL est un spot qui peut être utilisé comme plafonnier ou comme applique murale. Le boîtier est fabriqué en acier avec une attention particulière à chaque détail. Les spots de la gamme LARATA sont des produits haut de gamme qui répondront aux exigences des plus grands esthètes.

Matériau du boîtier: métal

Kanlux LARATA EL è un faretto orientabile da parete. L'alloggiamento è realizzato in acciaio curato in ogni dettaglio. Le lampade LARATA sono prodotti premium che soddisfano le esigenze estetiche più elevate.

Materiale del corpo: metallo



HIGH
quality
finish

DESIGN
unique

Kanlux LARATA E27 est une lampe de table en acier. La finition et le boîtier lui-même lui donnent de l'élégance et un aspect moderne. La lampe de table Kanlux LARATA est un produit unique, réalisé avec une attention particulière à chaque détail. Grâce à son poids, la lampe reste stable et ne vacille pas. Le bras se règle à l'aide de deux vis élégantes et le câble visible est placé dans une tresse esthétique.

Matériau du boîtier: métal

Kanlux LARATA E27 è una lampada da tavolo realizzata in metallo. Ha un aspetto originale e moderno. La lampada da tavolo Kanlux LARATA è un prodotto unico, realizzato con cura in ogni dettaglio. Grazie al suo peso, la lampada rimane stabile sulla superficie e non oscilla. Il braccio è regolato con l'ausilio di due eleganti viti, e il cavo a vista è inserito in una treccia esteticamente pregevole.

Materiale del corpo: metallo

Kanlux

FLUXY LED IP44

LAMPE DE TABLE LED ► LAMPADA DA TAVOLO LED

NEW



FLUXY LED IP44 GN



FLUXY LED IP44 W



FLUXY LED IP44 B



FLUXY LED IP44 BL



FLUXY LED IP44 Y



Kanlux FLUXY LED est une lampe de table multifonctionnelle sans fil. Elle a un design très moderne et élégant, est légère et facile à transporter. Elle est conçue pour l'intérieur et l'extérieur grâce à sa classe de protection IP44. Vous pouvez commander la lampe Kanlux FLUXY à l'aide d'un seul bouton (fonction on/off/variation) et la recharger à l'aide d'un port USB - C.

Matériau du boîtier: matériau plastique, métal

Matériau du diffuseur: matériau plastique

Kanlux FLUXY LED è una lampada da tavolo senza fili. Ha un design originale e molto moderno. È leggera e facile da trasportare ed è ideale per interni ed esterni grazie al grado IP44 Kanlux FLUXY è dotata della funzione dimming che permette di tarare l'intensità della luce. Si carica tramite una cavo USB-C.

Materiale del corpo: plastica, metallo
Diffusore: plastica



FLUXY LED IP44 W	37310	5905339373106	max 1,7	max 140	3000	blanc bianco
FLUXY LED IP44 B	37311	5905339373113	max 1,7	max 140	3000	noir nero
FLUXY LED IP44 BL	37312	5905339373120	max 1,7	max 140	3000	bleu azzurro
FLUXY LED IP44 GN	37313	5905339373137	max 1,7	max 140	3000	vert verde
FLUXY LED IP44 Y	37314	5905339373144	max 1,7	max 140	3000	jaune giallo

III	IP 44	III	IP 44
3,7 DC 18650 ACCU	80	SMD	DIMMING function
0,1m	max 82	CE	EAC
		UK PA	

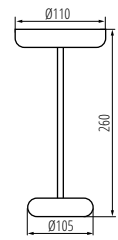

FLUXY LED IP44

Kanlux

INITA LED IP54

LAMPE DE TABLE LED ► LAMPADA DA TAVOLO LED

NEW



INITA LED IP54 B



INITA LED IP54 GN



INITA LED IP54 R



INITA LED IP54 Y



INITA LED IP54 W



INITA LED IP54 GN	36320	5905339363206	max 1,2	max 165	3000	vert verde
INITA LED IP54 B	36321	5905339363213	max 1,2	max 165	3000	noir nero
INITA LED IP54 R	36322	5905339363220	max 1,2	max 165	3000	rouge rosso
INITA LED IP54 Y	36323	5905339363237	max 1,2	max 165	3000	jaune giallo
INITA LED IP54 W	36324	5905339363244	max 1,2	max 165	3000	blanc bianco

3,7 DC 18650 ACCU		≥15000	25000	Ra 80	SMD	DIMMING function
	IP 54		-10+35			0,1m
max 138						



Kanlux INITA LED est un nouveau type de lampe de table multifonctionnelle sans fil. Le corps en métal, la texture lisse et mate et la couleur unie ne sont que quelques-unes de ses qualités. La lampe de table Kanlux INITA peut être actionnée par simple pression sur un bouton (fonction on/off/gradation) et rechargée via un port USB. Vous pouvez également utiliser cette lampe sur la terrasse ou dans le jardin grâce à la protection IP54. La lampe de table Kanlux INITA se monte et se démonte facilement pour être rangée dans vos bagages si vous souhaitez l'emmener en voyage.

Matériau du boîtier: métal

Matériau du diffuseur: alliage en aluminium

Kanlux INITA LED è un nuovo tipo di lampada da tavolo ricaricabile, priva di cavo. . Corpo in metallo, design moderno e colore sgargiante sono solo alcune delle sue caratteristiche. È possibile utilizzare la lampada Kanlux INITA con un solo pulsante (funzione on/off/dimming) e caricarla con una porta USB. Può essere utilizzata all'esterno su terrazze e tavoli in giardino grazie al grado IP54. La lampada da tavolo Kanlux INITA è facilmente smontabile, e potrai anche piegarla e inserirla nel tuo bagaglio - se vuoi portarla in viaggio.

Materiale del corpo: metallo

Diffusore: alluminio

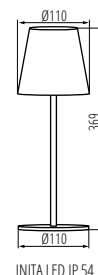

INITA LED IP 54

Kanlux

EVALO TL

LAMPE DE TABLE ► LAMPADA DA TAVOLO

NEW



EVALO TL GU10 W-SR



EVALO TL GU10 B-SR



EVALO TL est une lampe de table qui fait partie de la gamme EVALO. La simplicité scandinave et les joints argentés créent un classique très élégant. L'abat-jour étroit peut accueillir des sources GU10 (une ventouse est incluse pour faciliter le montage). Vous pouvez composer la lampe Kanlux EVALO TL avec les spots Kanlux EVALO et les lampadaires Kanlux EVALO FL.

Matériau du boîtier: alliage en aluminium

EVALO TL è una lampada da tavolo appartenente alla famiglia di lampade EVALO. Semplicità scandinava e giunti d'argento creano un modello classico ma elegante. Il diffusore cilindrico è dotato di un attacco gu10 e di una ventosa per facilitare la sostituzione della lampadina. È possibile combinare il Kanlux EVALO Lampada TL con Kanlux EVALO spot e Kanlux EVALO FL lampade da terra.

Materiale del corpo: alluminio

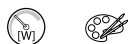

EVALO TL GU10 W-SR	35785	5905339357854	max 10	blanc bianco
EVALO TL GU10 B-SR	35786	5905339357861	max 10	noir nero

[V]	[Hz]	Lightbulb icon	Socket icon	Lightbulb icon	Lightbulb icon	Lightbulb icon
220-240 AC	50	PAR16	GU10	Lightbulb icon	Lightbulb icon	Lightbulb icon
IP 20	House icon	Temperature icon	Lightbulb icon	Lightbulb icon	Lightbulb icon	Lightbulb icon
Lightbulb icon	Lightbulb icon	Lightbulb icon	Lightbulb icon	Lightbulb icon	Lightbulb icon	Lightbulb icon
Lightbulb icon	Lightbulb icon	Lightbulb icon	Lightbulb icon	Lightbulb icon	Lightbulb icon	Lightbulb icon

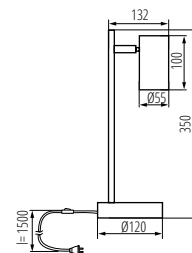

EVALO TL GU10

Kanlux

EVALO FL

LUMINAIRE SUR PIED ▶ LAMPADA DA TERRA

NEW

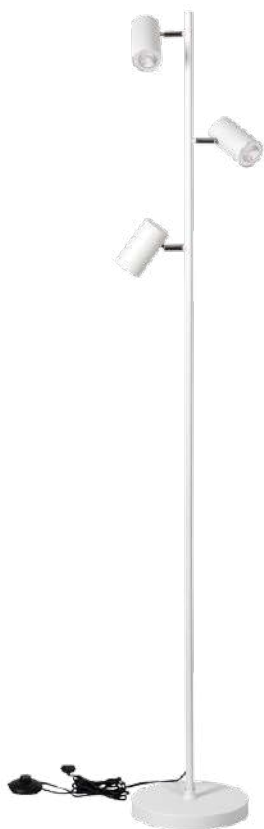

EVALO FL 3xGU10 W-SR

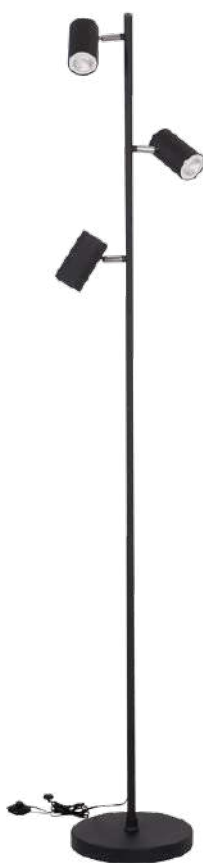

EVALO FL 3xGU10 B-SR



EVALO FL est un lampadaire qui fait partie de la gamme EVALO. Sa simplicité scandinave et ses joints argentés en font un classique très élégant. L'abat-jour étroit (la lampe a 3 points lumineux) peut accueillir des sources GU10 (ventouse incluse pour un montage facile). Vous pouvez composer la lampe Kanlux EVALO FL avec les spots Kanlux EVALI et les lampes de table Kanlux EVALO TL.

Matériau du boîtier: alliage en aluminium

EVALO FL è una lampada da terra appartenente alla famiglia Kanlux di lampade EVALO. Semplicità scandinava e giunti d'argento caratterizzano il design di questo articolo. Funziona con lampade con attacco GU10 (La ventosa inclusa ne facilita l'installazione). È possibile abbinare diversi prodotti della famiglia Evalo per rendere l'ambiente più uniforme.

Materiale del corpo: alluminio



EVALO FL 3xGU10 W-SR	35787	5905339357878	3 x max 10	blanc bianco
EVALO FL 3xGU10 B-SR	35788	5905339357885	3 x max 10	noir nero

[V] 220-240 AC	[Hz] 50	PAR16	GU10	Lightbulb icon	Lightbulb icon	Lightbulb icon
IP 20	House icon	Temperature icon 5+25	Socket icon	320	90	Lightbulb icon
Lightbulb icon	1,8	0,5m	CE	EAC	UK CA	Lightbulb icon

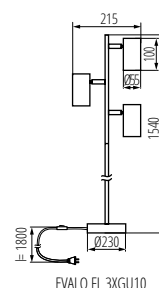

EVALO FL 3xGU10

Kanlux

RAIBO E27

LAMPE DE BUREAU ► LAMPADA DA SCRIVANIA



RAIBO E27 B



RAIBO E27 W



RAIBO E27 BL



RAIBO E27 Y



RAIBO E27 GN



RAIBO E27 PK



RAIBO E27 B	36280	5905339362803	max 5	noir nero
RAIBO E27 W	36281	5905339362810	max 5	blanc bianco
RAIBO E27 BL	36282	5905339362827	max 5	bleu azzurro
RAIBO E27 Y	36283	5905339362834	max 5	jaune giallo
RAIBO E27 GN	36284	5905339362841	max 5	vert verde
RAIBO E27 PK	36285	5905339362858	max 5	rose rosa

[VI] 220-240 AC	[Hz] 50			IP 20	 0,1m		 E27	
 190			 1,5	CE	EMC	UK		



Kanlux RAIBO est une lampe de bureau rétro à la mode. Il est disponible en 4 couleurs pastel ainsi qu'en noir et blanc très appréciés. La base a un organisateur intégré avec une poignée dans laquelle vous pouvez mettre un téléphone, des stylos ou des lunettes. Un grand abat-jour, dans lequel on peut loger une ampoule au culot E27, est à large diffusion lumineuse. L'influence rétro est ici visible, mais aussi le souci du détail et une finition solide (acier). Nous avons également prêté attention au dessous de la lampe et ajouté un coussin en mousse pour empêcher la lampe de rayer le bureau.

Matériau du boîtier: métal

Kanlux RAIBO è una lampada da scrivania dal design retrò. È disponibile in 4 colori pastello e nel più comune bianco e nero. La base ha un contenitore integrato che permette l'alloggiamento del telefonino oppure per poter riporre gli occhiali o le penne. Dotata di un grande paralume, ha un attacco E27, e garantisce una luce diffusa. L'influenza retrò è sottolineata dalle forme così come spiccano la cura dei dettagli e la solida qualità della struttura (metallo). Nella base abbiamo aggiunto un cuscinetto in schiuma per evitare che la lampada graffi la scrivania.

Materiale del corpo: metallo

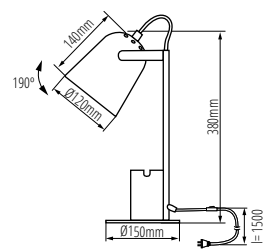

RAIBO E27

Kanlux

JUSI E27

LAMPE DE TABLE ► LAMPADA DA TAVOLO



JUSI E27 W



JUSI E27 B



JUSI E27 W	36270	5905339362704	max 5	blanc bianco
JUSI E27 B	36271	5905339362711	max 5	noir nero

[V]	[Hz]	E27	IP	5+25	180°
220-240 AC	50		20		



La lampe de table Kanlux JUSI E27 peut être utilisée comme lampe de bureau, lampe de nuit ou comme éclairage complémentaire de la pièce. Le design de cette lampe est si universel qu'elle s'adapte parfaitement à la chambre des jeunes comme au salon ou à la chambre à coucher. Nous décidons nous-mêmes du rendement lumineux grâce à la possibilité de changer l'ampoule E27. Le boîtier en acier et l'interrupteur marche/arrêt sur le cordon d'alimentation sont des caractéristiques supplémentaires. La nouveauté c'est la possibilité d'incliner le bras de 40 degrés et l'abat-jour de 180 degrés.

Matériau du boîtier: métal

La lampada da tavolo Kanlux JUSI E27 può essere utilizzata come lampada da scrivania, lampada da comodino o come illuminazione supplementare della stanza. Il design di questa lampada è così universale che si può adattare perfettamente alla stanza dei giovani, al soggiorno o alla camera da letto. Decidiamo noi stessi la potenza della luce grazie alla possibilità di sostituire la lampadina con attacco E27. Dotata di paralume in metallo e un interruttore montato sul cavo di alimentazione. È possibile inclinare il braccio di 40 gradi, il paralume è orientabile di 180 gradi.

Materiale del corpo: metallo

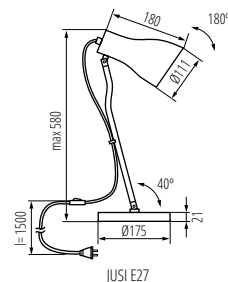

Kanlux

NEDIA E14

LAMPE DE TABLE ► LAMPADA DA TAVOLO



NEDIA E14 B



NEDIA E14 W



NEDIA E14 B	34475	5905339344755	max 10	noir nero
NEDIA E14 W	34476	5905339344762	max 10	blanc bianco

[V]	[Hz]	E14	IP	5+25	160°
220-240 AC	50		20		



KANLUX NEDIA est une lampe de table avec une source lumineuse remplaçable E14. La forme élégante de cette lampe s'avérera être un accessoire fonctionnel pour votre espace d'apprentissage et de travail. Kanlux NEDIA apportera également une touche décorative à une chambre ou un bureau. Il peut également constituer un éclairage d'appoint précieux pour votre salon. Un avantage supplémentaire de ce luminaire est l'articulation réglable et la haute qualité de fabrication. Kanlux NEDIA est doté d'un interrupteur mécanique ON/ OFF situé sur le cordon d'alimentation

Matériau du boîtier: acier

KANLUX NEDIA è una lampada da tavolo con lampada E14 intercambiabile. Dalla forma elegante, questa lampada si adatterà a qualsiasi luogo di studio e lavoro. Kanlux NEDIA può costituire un'illuminazione aggiuntiva nel tuo soggiorno. Kanlux NEDIA ha un interruttore ON/ OFF situato sul cavo di alimentazione ed è orientabile.

Materiale del corpo: metallo

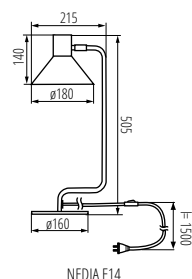

Kanlux PIXA

LAMPE DE BUREAU ► LAMPADA DA SCRIVANIA



PIXA KT-40-W

PIXA KT-40-B

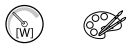

PIXA KT-40-W	19300	5905339193001	max 40	blanc bianco
PIXA KT-40-B	19301	5905339193018	max 40	noir nero

[V] 220-240 AC	[Hz] 50			IP 20	 0,1m			
 360	 180	 lm 1,6						

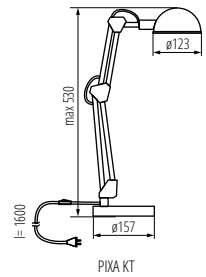

PIXA KT

Kanlux HERON II LED

LAMPE DE BUREAU LED ► LAMPADA DA SCRIVANIA LED



HERON II LED B

HERON II LED W



HERON II LED B	27602	5905339276025	4,8	noir nero	430	4000
HERON II LED W	27603	5905339276032	4,8	blanc bianco	430	4000

[V] 220-240 AC	[Hz] 50	 110	 ≥15000	 20000	 ≤6 MacAdam	 80		
	IP 20	 0,1m			 360	 180	 lm 1,7	
	 90							

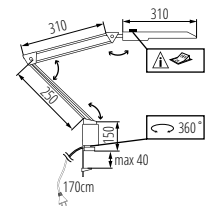

HERON II LED

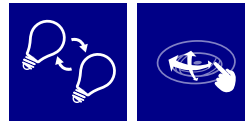

Kanlux PIXA est une lampe de bureau culte avec une source lumineuse remplaçable. Sa construction permet de diriger le flux lumineux dans toutes les directions, l'abat-jour de la lampe limitant la diffusion de la lumière sur les côtés. Cette lampe s'intègre facilement dans chaque espace : de la chambre des enfants jusqu'au bureau d'un PDG.

Matériau du boîtier: matériau plastique, métal

Matériau du diffuseur: métal

Kanlux PIXA è una famosa lampada da scrivania con una sorgente luminosa intercambiabile. La lampada è orientabile e si abbina con facilità a tutti gli ambienti grazie al suo design moderno.

Materiale del corpo: plastica, metallo

Diffusore: metallo

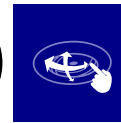

Kanlux HERON LED est une lampe de bureau avec de nombreux avantages. Le luminaire est équipé d'un interrupteur et d'une pince qui permet de fixer la base au bord d'une table ou d'une étagère. Le bras de la lampe mobile et pliable permet une orientation précise du flux lumineux vers l'endroit souhaité. Kanlux HERON LED est très appréciée par des personnes qui aiment le design moderne et austère.

Matériau du boîtier: alliage en aluminium

Matériau du diffuseur: matériau plastique

HERON II è la nuova versione della nota lampada da scrivania a LED già presente nel catalogo Kanlux. Si caratterizza per un minor consumo energetico, una più elevata efficienza luminosa e per la possibilità di orientare il fascio di luce praticamente in tutte le direzioni. Questo è reso possibile grazie ai giunti regolabili HERON II LED ha un interruttore situato sul paralume e un morsetto che consente di fissare la base al bordo di un piano da lavoro, di un tavolo o di una mensola. Kanlux HERON II LED è apprezzata da coloro che amano un design moderno e austero e la praticità di una lampada adatta a qualsiasi ambiente, tanto per lo studio quanto per il lavoro.

Materiale del corpo: alluminio

Diffusore: plastica

Kanlux ZARA

LAMPE DE BUREAU ► LAMPADA DA SCRIVANIA



ZARA HR-40-B



ZARA HR-40-SR	07560	5905339075604	max 40	argent argento
ZARA HR-40-B	07561	5905339075611	max 40	noir nero
ZARA HR-40-W	07564	5905339075642	max 40	blanc bianco

NEW

[V]	[Hz]			IP				
220-240 AC	50			20	0,2m		E14	
360	360	1,5						



ZARA HR-40-SR



ZARA HR-40-W

NEW



La série de lampes de bureau Kanlux ZARA est un modèle culte qui rencontre un grand succès depuis des années. Grâce à sa simplicité et à son aspect classique, cette lampe trouvera sa place sur n'importe quel bureau. Les couleurs classiques et la source lumineuse E14 remplaçable sont également ses atouts.

Matériau du boîtier: acier
Matériau du diffuseur: acier

Kanlux ZARA è un modello di lampada da tavolo iconico che ha goduto di un costante successo negli anni. Grazie alla sua semplicità e ad un aspetto classico, questa lampada si adatterà perfettamente a qualsiasi scrivania. Orientabile e dal colore classico e' dotata di un attacco e14 che permette l'intercambiabilità della lampada led.

Materiale del corpo: metallo
Diffusore: metallo

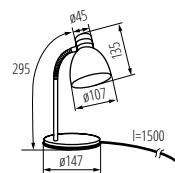

ZARA HR-40

Kanlux SUZI

LAMPE DE BUREAU ► LAMPADA DA SCRIVANIA



SUZI HR-60-B



SUZI HR-60-SR	07150	5905339071507	max 40	argent argento
SUZI HR-60-B	07151	5905339071514	max 40	noir nero
SUZI HR-60-BL	07152	5905339071521	max 40	bleu azzurro
SUZI HR-60-PK	07153	5905339071538	max 40	rose rosa
SUZI HR-60-W	07154	5905339071545	max 40	blanc bianco

NEW

[V]	[Hz]			IP				
220-240 AC	50			20	0,2m		E27	
360	360	1,5						



SUZI HR-60-SR



SUZI HR-60-BL



SUZI HR-60-PK



SUZI HR-60-W

NEW



Kanlux SUZI est une simple lampe de bureau. Elle est disponible dans quelques variantes unicolores. Kanlux SUZI est dotée d'un bras réglable et d'une pince qui permet de fixer la lampe à la surface du bureau ou à une étagère.

Bras-support flexible
Installation à l'aide d'un clip
Matériau du boîtier: matériau plastique
Matériau du diffuseur: acier

Kanlux SUZI è una semplice lampada da scrivania. È disponibile in diverse versioni di colori uniformi. Kanlux SUZI è dotata di un braccio regolabile e una clip che permette di montare la lampada sul bordo della scrivania o sulla mensola.

Materiale del corpo: plastica
Diffusore: metallo

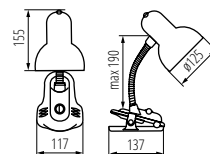

SUZI HR-60

Kanlux

PREDA LED

LAMPE DE BUREAU LED ► LAMPADA DA SCRIVANIA LED



PREDA LED B



PREDA LED W



Kanlux PREDA est une lampe de bureau multifonctionnelle. Elle se distingue par son flux lumineux élevé (pour une lampe de bureau) - jusqu'à 620 lumens (modèle blanc) et se caractérise par la possibilité de changer la couleur de lumière. Une particularité est la possibilité d'incliner le bras de la lampe de 45 degrés autour de son propre axe. La lampe est équipée d'un port USB permettant de recharger les appareils mobiles. Vous pouvez utiliser cette lampe pour éclairer le bureau ou un espace de travail plus important. Elle peut également être utilisée dans les salons de beauté.

Matériau du boîtier: matériau plastique
 Matériau du diffuseur: matériau plastique
 Matériau du support: matériau plastique

Kanlux PREDA è una lampada da scrivania multifunzionale. Si distingue per un flusso luminoso elevato (come per le lampade da scrivania) - fino a 620 lumen (modello bianco). È dimmerabile ed è possibile cambiare la tonalità di colore della luce. Una caratteristica unica è la possibilità di richiudere il braccio della lampada attorno al proprio asse di 45 gradi. La lampada è dotata di una porta USB, grazie alla quale possiamo caricare i dispositivi mobili. Ideale sulla vostra scrivania o nel posto di lavoro. E' anche adatta nei saloni di bellezza.

Materiale del corpo: plastica
 Diffusore: plastica
 Materiale del braccio: plastica

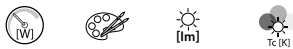

PREDA LED B	35780	5905339357809	max 7,3	noir nero	max 570	3000/5000/6500
PREDA LED W	35781	5905339357816	max 7,3	blanc bianco	max 620	3000/5000/6500

[V]	[Hz]	[W]	[h]	diptose	Ra	SMD	DIMMING function
220-240 AC	50	15000	25000	5 or Macadam	80		
[IP]	[Watt]	[lm]	[°]	[°]	[lm]	[lm]	[lm]
	IP 20		45	150			1,8
CE	ERL	UK CA					

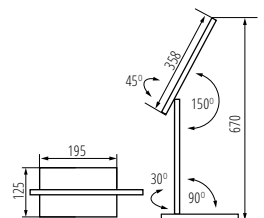

PREDA LED

Kanlux REXAR LED

LAMPE DE BUREAU LED ► LAMPADA DA SCRIVANIA LED



REXAR LED B

REXAR LED W



Lampe de bureau Kanlux REXAR combine un design minimaliste, élégant et plein de fonctions. Vous pouvez régler la couleur de la lumière et son intensité à votre convenance, ainsi qu'utiliser le port USB pour recharger un appareil mobile, après avoir fini le travail la lampe pliée n'occupe pas beaucoup de place et remplira la fonction d'un décor minimaliste.

Matériau du boîtier: alliage en aluminium, matériau plastique

Kanlux REXAR è la lampada da scrivania dal design minimalista ed elegante e dalle svariate funzioni. È possibile regolare liberamente il colore della luce e la sua intensità, così come utilizzare la porta USB per ricaricare un dispositivo mobile. Al termine del lavoro, la lampada ripiegata non occuperà molto spazio e fungerà da decorazione minimalista.

Materiale del corpo: alluminio, plastica

REXAR LED W	33070	5905339330703	max 7	blanc bianco	max 420	3000/4000/6500
REXAR LED B	33071	5905339330710	max 7	noir nero	max 370	3000/4000/6500

[VI] 220-240 AC	[Hz] 50	[°] 100	[lm] ≥15000	[h] 25000	diptose ≤6x Nachdam	Ra 80	SMD	[lm] 1,8
DIMMING function	[IP] 20	[m] 0,1m	[°] 180	[m] 1,8	[m] 1,8	[m] 1,8	[m] 1,8	[m] 1,8
[CE]	[EAC]	[UK CA]	[UK CA]	[UK CA]	[UK CA]	[UK CA]	[UK CA]	[UK CA]

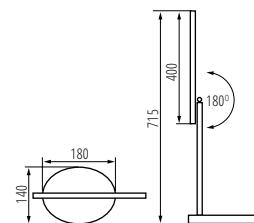

REXAR LED

Kanlux FRANCO II / FRANCO LED

LAMPE DE BUREAU LED ► LAMPADA DA SCRIVANIA LED



FRANCO B

FRANCO W



Kanlux FRANCO est une lampe à pied élégante avec des formes arrondies. Elle est parfaite pour éclairer le bureau, mais aussi comme éclairage supplémentaire de la pièce ou comme lampe de chevet. Une solution pratique est la possibilité de régler l'intensité lumineuse qui permet d'adapter la luminosité à nos besoins et à l'heure du jour.

équipé d'un capteur placé dans la base permettant, par le toucher, d'allumer ou d'éteindre la lampe ou d'ajuster l'intensité lumineuse (3 niveaux de luminosité)

Matériau du boîtier: matériau plastique

Matériau du diffuseur: matériau plastique

Kanlux FRANCO è una lampada a stelo a forma slanciata, discreta ma al contempo elegante. Ideale come illuminazione da scrivania, ma anche come illuminazione aggiuntiva della stanza o come lampada da notte. La possibilità di regolare l'intensità luminosa è una soluzione molto comoda, permettendo di personalizzare la luminosità dell'illuminazione in base alle proprie esigenze e all'ora del giorno.

La base è provvista di un sensore che permette l'accensione o lo spegnimento della lampada e di dimmerarne la luminosità (3 livelli)

Materiale del corpo: plastica

Diffusore: plastica

FRANCO 15LED SMD KT-W	22340	5905339223401	max 6,5	blanc bianco	max 390	3000
FRANCO 15LED SMD KT-B	22341	5905339223418	max 6,5	noir nero	max 390	3000

[VI] 220-240 AC	[Hz] 50	[°] 100	[lm] ≥10000	[h] 20000	diptose ≤6x Nachdam	Ra 80	SMD	[lm] 1,8
DIMMING function	[IP] 20	[m] 0,1m	[°] 360	[m] 360	[m] 1,8	[m] 1,8	[m] 1,8	[m] 1,8
[CE]	[EAC]	[UK CA]	[UK CA]	[UK CA]	[UK CA]	[UK CA]	[UK CA]	[UK CA]

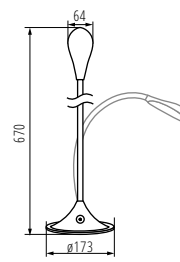

FRANCO

GLOZO DSO

SPOT ► FARETTO INCASSO



GLOZO DSO W/W



GLOZO DSO B/W



GLOZO DSO G/W



GLOZO DSO SR/W



GLOZO DSO B/B



GLOZO DSO G/B



GLOZO DSO SR/B



GLOZO DSO W/B



Kanlux GLOZO est une grande famille de spots décoratifs. Ils ont un boîtier modulaire: une base en deux formes et couleurs et un réflecteur en 4 couleurs en mat ou brillant. Cela donne de nombreuses possibilités d'utilisation pour juxtaposer des solutions de couleurs identiques ou différentes.

Anneau décoratif sans douille céramique
Matériau du boîtier: alliage en aluminium

Kanlux GLOZO è una grande famiglia di faretto da incasso. Hanno un alloggiamento modulare: una base in due forme e colori e un riflettore in 4 colori opaco o lucido. È possibile combinare fra loro diversi colori e forme

Decorazione ad anello senza cornice in ceramica

Materiale del corpo: alluminio



GLOZO DSO W/W	36218	5905339362186	max 10	blanc bianco	non	non disponibile
GLOZO DSO B/W	36219	5905339362193	max 10	noir / blanc nero / bianco	non	non disponibile
GLOZO DSO G/W	36220	5905339362209	max 10	or / blanc oro / bianco	non	non disponibile
GLOZO DSO SR/W	36221	5905339362216	max 10	argent / blanc argento / bianco	non	non disponibile
GLOZO DSO W/B	36222	5905339362223	max 10	blanc / noir bianco / nero	non	non disponibile
GLOZO DSO B/B	36223	5905339362230	max 10	noir nero	non	non disponibile
GLOZO DSO G/B	36224	5905339362247	max 10	or / noir oro / nero	non	non disponibile
GLOZO DSO SR/B	36225	5905339362254	max 10	argent / noir argento / nero	non	non disponibile

[V]										
12 AC; 12 DC; 220-240 AC	G65,3/GU10	MR16/PAR16	CE	UK	CA	IP 20	5+25	Ø75	0,5m	Ø89

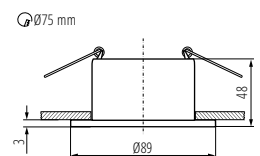

GLOZO DSO

Kanlux

GLOZO DSL

SPOT ► FARETTO INCASSO



GLOZO DSL W/W



GLOZO DSL B/W



GLOZO DSL G/W



GLOZO DSL SR/W



GLOZO DSL B/B



GLOZO DSL G/B



GLOZO DSL SR/B



GLOZO DSL W/B

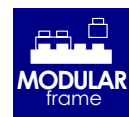

Kanlux GLOZO est une grande famille de spots décoratifs. Ils ont un boîtier modulaire: une base en deux formes et couleurs et un réflecteur en 4 couleurs en mat ou brillant. Cela donne de nombreuses possibilités d'utilisation pour juxtaposer des solutions de couleurs identiques ou différentes.

Anneau décoratif sans douille céramique
Matériau du boîtier: alliage en aluminium

Kanlux GLOZO è una grande famiglia di faretto da incasso. Hanno un alloggiamento modulare: una base in due forme e colori e un riflettore in 4 colori opaco o lucido. E' possibile combiare fra loro diversi colori e forme

Decorazione ad anello senza cornice in ceramica

Materiale del corpo: alluminio



GLOZO DSL W/W	36210	5905339362100	max 10	blanc bianco	non	non disponibile
GLOZO DSL B/W	36211	5905339362117	max 10	noir / blanc nero / bianco	non	non disponibile
GLOZO DSL G/W	36212	5905339362124	max 10	or / blanc oro / bianco	non	non disponibile
GLOZO DSL SR/W	36213	5905339362131	max 10	argent / blanc argento / bianco	non	non disponibile
GLOZO DSL W/B	36214	5905339362148	max 10	blanc / noir bianco / nero	non	non disponibile
GLOZO DSL B/B	36215	5905339362155	max 10	noir nero	non	non disponibile
GLOZO DSL G/B	36216	5905339362162	max 10	or / noir oro / nero	non	non disponibile
GLOZO DSL SR/B	36217	5905339362179	max 10	argent / noir argento / nero	non	non disponibile

12 AC; 12 DC; 220-240 AC											
Ø75	0,5m	6x5,3/GU10	MR16/PAR16	CE	UK	CA	IP 20	5+25	88x88	48	88x88

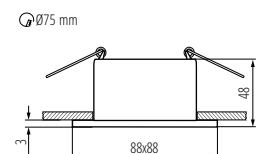

GLOZO DSL

Kanlux

FELINE DSO

SPOT ► FARETTO INCASSO

NEW



FELINE DSO B/B



Kanlux FELINE DSO sont des plafonniers ronds et élégants. Il existe 6 versions de couleurs différentes pour s'adapter à votre intérieur.

Matériau du boîtier: alliage en aluminium

Kanlux FELINE DSO sono faretto incasso rotondi e dal design moderno. Disponibili in 6 colori si caratterizzano per il fatto che la luce viene diffusa anche dall'anello perimetrale.

Faretto senza portalampada
Materiale del corpo: alluminio



FELINE DSO W/B



FELINE DSO G/B



FELINE DSO B/W



FELINE DSO G/W



FELINE DSO W/W



FELINE DSO B/B	37250	5905339372505	max 10	noir nero	non non disponibile
FELINE DSO G/B	37251	5905339372512	max 10	or / noir oro / nero	non non disponibile
FELINE DSO W/B	37252	5905339372529	max 10	blanc / noir bianco / nero	non non disponibile
FELINE DSO W/W	37253	5905339372536	max 10	blanc bianco	non non disponibile
FELINE DSO G/W	37254	5905339372543	max 10	or / blanc oro / bianco	non non disponibile
FELINE DSO B/W	37255	5905339372550	max 10	noir / blanc nero / bianco	non non disponibile

[VI]						
12 AC; 12 DC; 220-240 AC	0,5m	MR16/PAR16	CE	UK CA		5+25
Ø77						

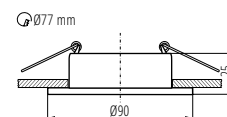

FELINE DSO

Kanlux

FELINE DSL

SPOT ► FARETTO INCASSO

NEW



FELINE DSL B/B



FELINE DSL W/B



FELINE DSL G/B



FELINE DSL B/W



FELINE DSL G/W



FELINE DSL W/W



FELINE DSL B/B	37256	5905339372567	max 10	noir nero	non non disponibile
FELINE DSL G/B	37257	5905339372574	max 10	or / noir oro / nero	non non disponibile
FELINE DSL W/B	37258	5905339372581	max 10	blanc / noir bianco / nero	non non disponibile
FELINE DSL W/W	37259	5905339372598	max 10	blanc bianco	non non disponibile
FELINE DSL B/W	37260	5905339372604	max 10	noir / blanc nero / bianco	non non disponibile
FELINE DSL G/W	37261	5905339372611	max 10	or / blanc oro / bianco	non non disponibile

IV1												
12 AC; 12 DC; 220-240 AC												
Ø77												



GOVIK DSO-W



DESIGN unique
unique LIGHT effect
HIGH quality finish

KANLUX GOVIK est un nouveau luminaire à encastrer avec une structure unique. L'utilisation d'un petit verre en acrylique permet de diffuser la lumière et rendre invisible la source lumineuse installée. Le luminaire ressemble à une minuscule applique en saillie intégrée.

Anneau décoratif sans douille céramique
 Matériau du boîtier: alliage en aluminium

Kanlux GOVIK è un nuovo faretto da incasso dal design unico. Il paralume opaco in acrilico diffonde la luce e rende invisibile la sorgente luminosa.

Faretto senza portalampada
 Materiale del corpo: alluminio



GOVIK DSO-W/G	29231	5905339292315	max 10	blanc / or bianco / oro	non non disponibile
GOVIK DSO-B/G	29232	5905339292322	max 10	noir / or nero / oro	non non disponibile
GOVIK-ST DSO-W/G	29233	5905339292339	max 10	blanc / or bianco / oro	non non disponibile
GOVIK-ST DSO-B/G	29234	5905339292346	max 10	noir / or nero / oro	non non disponibile
GOVIK DSO-W	29235	5905339292353	max 10	blanc bianco	non non disponibile
GOVIK DSO-B	29236	5905339292360	max 10	noir nero	non non disponibile
GOVIK-ST DSO-B	29237	5905339292377	max 10	noir nero	non non disponibile
GOVIK-ST DSO-W	29238	5905339292384	max 10	blanc bianco	non non disponibile

[VI]					
12 AC; 12 DC; 220-240 AC		0,5m			

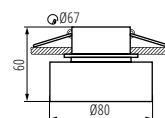

GOVIK DSO

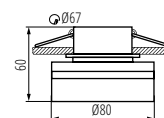

GOVIK-ST DSO

Kanlux
GOVIK

SPOT ► FARETTO INCASSO



GOVIK DSO-W/G



GOVIK-ST DSO-W/G



GOVIK DSO-B/G



GOVIK-ST DSO-B/G



GOVIK-ST DSO-B



GOVIK-ST DSO-W



GOVIK DSO-B



CHIRO GU10

SPOT ► FARETTO DECORATIVO ORIENTABILE



CHIRO GU10 DTO-B



CHIRO GU10 DTL-B



CHIRO GU10 DTO-W



MO
DE
RN
design

DE
SI
GN
unique

Kanlux CHIRO GU10 est une solution tout à fait nouvelle dans la catégorie de l'éclairage de décoration. C'est un luminaire de type SPOT qui peut être encastré dans un faux plafond comme un simple point lumineux. Les plus grands atouts du luminaire sont son design unique et son type d'installation.

Matériau du boîtier: alliage en aluminium

Kanlux CHIRO GU10 è un nuovo prodotto decorativo: si tratta di un faretto da incasso SPOT. Il design unico lo rende particolarmente originale ma al tempo stesso funzionale. Il faretto è orientabile.

Materiale del corpo: alluminio



CHIRO GU10 DTO-W	29310	5905339293107	max 10	blanc bianco	dans un axe su un asse	90
CHIRO GU10 DTO-B	29311	5905339293114	max 10	noir nero	dans un axe su un asse	90
CHIRO GU10 DTL-B	29313	5905339293138	max 10	noir nero	dans un axe su un asse	90

[V]	[Hz]	GU10	IP	5+25	340	Ø70
220-240 AC	50		20			
0,75-1,5	0,5m	PAR16	CE	ERC	UK CA	

Ø70

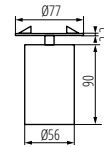

CHIRO GU10 DTO

Ø70

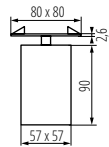

CHIRO GU10 DTL

Kanlux SPAG

SPOT ► FARETTO INCASSO



SPAG C B-G



SPAG S B-G



SPAG D W-G



SPAG D B-G

MO
DE
RN
design

Kanlux SPAG sont des spots décoratifs élégants. La combinaison de l'or avec du noir ou du blanc ajoute une touche subtile de charme à ces luminaires. Grâce aux formes différentes des luminaires Kanlux SPAG, nous pouvons créer des arrangements lumineux uniques et stylés dans nos salons, des restaurants élégants et des appartements d'hôtels.

Anneau décoratif sans douille céramique

Matériau du boîtier: alliage en aluminium

Kanlux SPAG sono eleganti faretto incasso decorativi. La combinazione dell'oro e del classico nero o bianco dona un discreto fascino. Grazie alle diverse forme, i faretto Kanlux SPAG sono in grado di creare scenari unici e di buon gusto.

Faretto senza portalampada

Materiale del corpo: alluminio



SPAG S B/G	27322	5905339273222	max 10	noir / or nero / oro	non non disponibile
SPAG C B/G	27324	5905339273246	max 10	noir / or nero / oro	non non disponibile
SPAG D B/G	27326	5905339273260	max 10	noir / or nero / oro	non non disponibile
SPAG D W/G	27327	5905339273277	max 10	blanc / or bianco / oro	non non disponibile

[V]	IP	5+25
12 AC; 12 DC; 220-240 AC	20	
Ø61-62	UK CA	

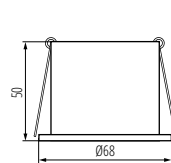

SPAG D

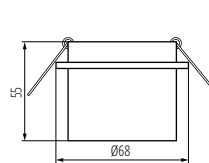

SPAG S

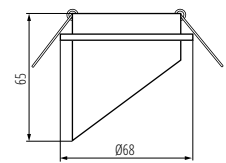

SPAG C

MINI RITI

SPOT ► FARETTO DECORATIVO ORIENTABILE



MINI RITI GU10 W/G



MINI RITI GU10 B/G



MINI RITI GU10 B/G	27575	5905339275752	max 10	noir / or nero / oro	non non disponibile
MINI RITI GU10 W/G	27576	5905339275769	max 10	blanc / or bianco / oro	non non disponibile
MINI RITI GU10 B/W	27577	5905339275776	max 10	noir / blanc nero / bianco	non non disponibile
MINI RITI GU10 B/B	27578	5905339275783	max 10	noir nero	non non disponibile
MINI RITI GU10 W/W	27579	5905339275790	max 10	blanc bianco	non non disponibile

[V] 220-240 AC	[Hz] 50	GU10	IP 20	5+25	Ø68*71
1+2,5	0,5m	PAR16	CE	UK CA	



MINI RITI GU10 B/W



MINI RITI GU10 B/B



MINI RITI GU10 W/W

MODERN design

HIGH quality finish

Kanlux MINI RITI est une version plus petite du luminaire RITI. Il est proposé en deux versions - noire et blanc, mais chacune d'elles propose plusieurs réflecteurs de couleurs - blanc, noir ou or. Un choix aussi large garantit que Kanlux MINI RITI une adaptation adapté à tout type d'intérieur. Si vous préférez un style original, vous pouvez combiner différents couleurs de luminaires ou les combiner avec Kanlux RITI. Ensemble, ils créeront un luminaire d'ambiance harmonieux mais inhabituel. Kanlux MINI RITI peut aussi être combiné avec RITI REF.

Matériau du boîtier: alliage en aluminium

Kanlux MINI RITI è una versione più piccola e leggermente più bassa del popolare lampada Kanlux RITI. Kanlux MINI RITI è un faretto realizzato in alluminio. La struttura del corpo sabbiato è laccata opaca in un elegante bianco o nero, a scelta. Kanlux MINI RITI è caratterizzato da una fattura di qualità e un design moderno. È possibile usarlo come fonte di illuminazione autonoma o in combinazione con altre lampade. La sostituzione della lampadina è facile e molto rapida. È possibile scegliere una parabola color oro-rame in finitura lucida, bianca o nera. Come opzione aggiuntiva è disponibile la parabola in argento: Kanlux RITI REF.

Materiale del corpo: alluminio

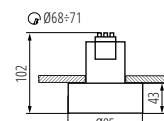

MINI RITI GU10

MINI GORD

SPOT ► FARETTO INCASSO



MINI GORD DLP-50-W



MINI GORD DLP-50-W	28780	5905339287809	max 10	blanc bianco	dans un axe su un asse	30
MINI GORD DLP-50-B	28781	5905339287816	max 10	noir nero	dans un axe su un asse	30

[V] 12 AC; 12 DC; 220-240 AC	6x5,3/GU10	IP 20	5+25	Ø85	0,5m	MR16/PAR16	CE	UK CA	
---------------------------------	------------	----------	------	-----	------	------------	----	-------	--



MINI GORD DLP-50-B



MODERN design

HIGH quality finish

Version mini de luminaires GORD. Une alternative parfaite pour les personnes qui souhaitent utiliser des luminaires encastrés dans un plafond suspendu, car ils sont installés de la même manière que les luminaires encastrés de type spot. Un autre avantage est l'orientation angulaire des luminaires MINI GORD sur une plage de 30°.

Anneau décoratif sans douille céramique

Matériau du boîtier: alliage en aluminium, acier

Versione mini degli apparecchi di illuminazione GORD. Un'alternativa perfetta per chi desidera utilizzare apparecchi a plafoniera su controsoffitto, perché il modo in cui vengono installati è lo stesso che nel caso delle luci ad incasso tipo occhio. Un ulteriore vantaggio è la regolazione dell'angolo degli apparecchi MINI GORD nel raggio di 30°.

Faretto senza portalampada

Materiale del corpo: alluminio, metallo

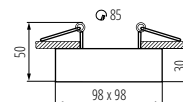

MINI GORD DLP-50

Kanlux

MINI BORD

SPOT ► FARETTO INCASSO



MINI BORD DLP-50-W



MINI BORD DLP-50-B



Version mini de luminaires BORD. Une alternative parfaite pour les personnes qui souhaitent utiliser des luminaires encastrés dans un plafond suspendu, car ils sont installés de la même manière que les luminaires encastrés de type spot. Un autre avantage est l'orientation angulaire des luminaires MINI BORD sur une plage de 30 °.

Anneau décoratif sans douille céramique
Matériau du boîtier: alliage en aluminium, acier

Versione mini degli apparecchi di illuminazione BORD. Un'alternativa perfetta per chi desidera utilizzare apparecchi a plafoniera su controsoffitto, perché il modo in cui vengono installati è lo stesso che nel caso delle luci ad incasso tipo occhio. Un ulteriore vantaggio è la regolazione dell'angolo degli apparecchi di illuminazione MINI BORD nel raggio di 30°.

Faretto senza portalampada
Materiale del corpo: alluminio, metallo



MINI BORD DLP-50-W	28782	5905339287823	max 10	blanc bianco	dans un axe	su un axe	30
MINI BORD DLP-50-B	28783	5905339287830	max 10	noir nero	dans un axe	su un axe	30

[V] 12 AC; 12 DC; 220-240 AC		 Gx5,3/GU10			IP 20		 5+25
 Ø85	 0,5m	 MR16/PAR16					

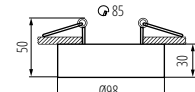

MINI BORD DLP-50

Kanlux

TINY BORD

SPOT ► FARETTO INCASSO

NEW



TINY BORD DTO-B



TINY BORD DTO-B/G



TINY BORD DTO-W



TINY BORD DTO-W/G



Kanlux TINY BORD est une version miniature des luminaires MINI BORD. Comme MINI BORD, KANLUX TINY BORD est un spot décoratif encastré. TINY BORD garantit un éclairage unique permettant de mettre en valeur des éléments choisis du décor et de créer une ambiance chaleureuse. Grâce à leur design moderne et simple, ces spots conviennent aussi bien aux intérieurs résidentiels que commerciaux. Il existe un choix de plusieurs combinaisons de couleurs, parmi lesquelles chacun pourra choisir ce qui lui convient.

Matériau du boîtier: alliage en aluminium

Kanlux TINY BORD è la versione mini dei popolari faretto (non da incasso) Kanlux MINI BORD. Come la famiglia Kanlux MINI BORD, anche KANLUX TINY BORD è caratterizzata dal portalampada a scomparsa. Kanlux TINY BORD garantisce un'illuminazione eccezionale che consente di valorizzare elementi di arredo e creare un'atmosfera piacevole. Il design moderno e semplice rende i faretto adatti sia agli interni residenziali che commerciali. È possibile scegliere tra diverse combinazioni di colori.

Materiale del corpo: alluminio



TINY BORD DTO-B	37165	5905339371652	max 10	noir nero	dans un axe	su un axe	30
TINY BORD DTO-B/G	37166	5905339371669	max 10	noir / or nero / oro	dans un axe	su un axe	30
TINY BORD DTO-W	37167	5905339371676	max 10	blanc bianco	dans un axe	su un axe	30
TINY BORD DTO-W/G	37168	5905339371683	max 10	blanc / or bianco / oro	dans un axe	su un axe	30

[V] 12 AC; 12 DC; 220-240 AC		 Gx5,3/GU10			IP 20		 5+25
 Ø85	 0,5m	 MR16/PAR16					

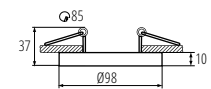

TINY BORD DTO

Kanlux AGEO

SPOT ► FARETTO INCASSO



AGEO DSO-W



AGEO DSO-B	33165	5905339331656	max 10	noir nero	dans un axe su un asse	20
AGEO DSO-W	33166	5905339331663	max 10	blanc bianco	dans un axe su un asse	20

[V] 12 AC; 12 DC; 220-240 AC					IP 20		 5+25
 Ø95	 0,5m						



AGEO DSO-B

DESIGN
unique

unique
LIGHT
effect

Kanlux AGEO est un spot avec la source lumineuse complètement cachée derrière une vasque orientable qui fournit un effet lumineux surprenant. Kanlux AGEO donne la possibilité de régler la direction de la lumière dans une plage de 20 degrés. Le luminaire est vendu sans la douille vous décidez de la source lumineuse à utiliser (le Gx5.3 ou le culot GU10).

Anneau décoratif sans douille céramique

Matériau du boîtier: alliage en aluminium

Kanlux AGEO è un particolare faretto decorativo versatile e adatto ad ogni stanza. La lampadina è completamente nascosta nel paralume orientabile e crea un interessante effetto luminoso. Kanlux AGEO è un faretto direzionabile con un angolo di 20 gradi. Il faretto viene venduto senza il portalampada: è compatibile con portalampada Gx5.3 o GU10.

Faretto senza portalampada

Materiale del corpo: alluminio

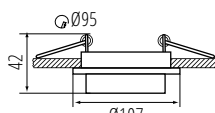

AGEO DSO

Kanlux IMINES

SPOT ► FARETTO INCASSO



IMINES DSO-W



IMINES DSO-W	29031	5905339290311	max 10	blanc mat bianco opaco	non non disponibile	
--------------	--------------	---------------	--------	--------------------------	-----------------------	--

[V] 12 AC; 12 DC; 220-240 AC					IP 20		 5+25
 Ø95	 0,5m						



unique
LIGHT
effect

DESIGN
unique

Kanlux IMINES est un luminaire unique en son genre qui surprend par son effet lumineux: lorsque vous mettez la lumière, vous obtenez en plus un anneau lumineux.

Anneau décoratif sans douille céramique

Matériau du boîtier: alliage en aluminium, matériau plastique

Kanlux IMINES è un faretto unico nel suo genere. Accendendo si ottiene una gradevole luce decorativa supplementare.

Faretto senza portalampada

Materiale del corpo: alluminio, plastica

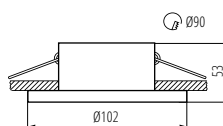

IMINES DSO

Kanlux APRILA

SPOT ► FARETTO INCASSO



APRILA DTO-W



APRILA DTO-W	26738	5905339267382	max 10	blanc mat bianco opaco	dans un axe su un asse	20
--------------	--------------	---------------	--------	--------------------------	--------------------------	----

[V] 12 AC; 12 DC; 220-240 AC					IP 20		 5+25
 Ø90	 0,5m						

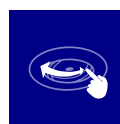

Kanlux APRILA est une gamme de spots d'anneaux blancs de décoration, fabriqués en aluminium. Kanlux APRILA a une forme arrondie et donne la possibilité de régler l'angle du flux lumineux dans une plage de 20 degrés. Il est possible d'utiliser les luminaires avec les boîtiers JDR ou MR-16, ce qui permettra d'installer des sources lumineuses adaptées au projet.

Anneau décoratif sans douille céramique

Matériau du boîtier: alliage en aluminium

Kanlux APRILA sono una famiglia di faretto incasso decorativi di color bianco. Interamente realizzati in alluminio. I Kanlux APRILA sono orientabili e caratterizzati da una forma arrotondata. Compatibili con lampadine con attacco JDR oppure MR-16.

Faretto senza portalampada

Materiale del corpo: alluminio

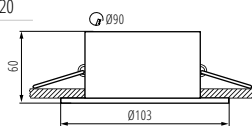

APRILA DTO

Kanlux SEIDY

SPOT ► FARETTO DECORATIVO ORIENTABILE

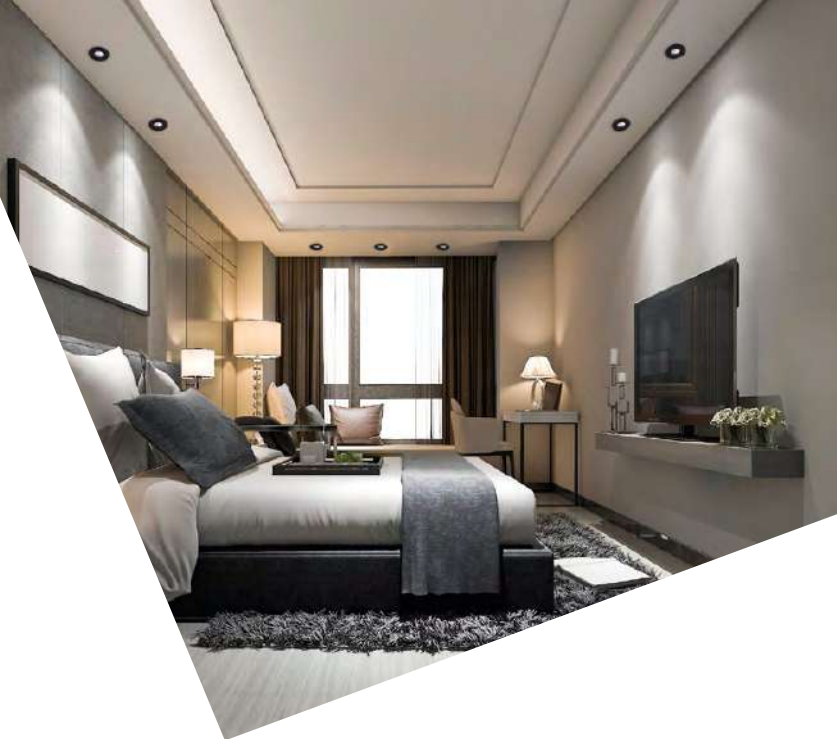

SEIDY CT-DT050-B/M



Kanlux SEIDY est une gamme de luminaires très prisée qui donne la possibilité de choisir entre des luminaires avec de 1 à 4 points lumineux. Nous pouvons en créer une composition d'éclairage parfaite pour des cafés, des espaces hôteliers, mais aussi pour l'intimité du foyer.

Matériau du boîtier: alliage en aluminium

Kanlux SEIDY è una famosa famiglia di faretto incasso disponibile in 4 varianti. Possono essere combinati per creare l'illuminazione perfetta per caffetterie, interni d'albergo ma anche per ambienti domestici.

Materiale del corpo: alluminio



SEIDY CT-DT050-AL	18280	5905339182807	max 10	aluminium brossé	alluminio spazzolato	dans un axe	su un asse	30
SEIDY CT-DTL50-AL	18281	5905339182814	max 10	aluminium brossé	alluminio spazzolato	dans un axe	su un asse	30
SEIDY CT-DT050-B	18288	5905339182883	max 10	noir anodisé	nero anodizzato	dans un axe	su un asse	30
SEIDY CT-DTL50-B	18289	5905339182890	max 10	noir anodisé	nero anodizzato	dans un axe	su un asse	30
SEIDY CT-DTL50-W/M	19454	5905339194541	max 10	blanc mat	bianco opaco	dans un axe	su un asse	30
SEIDY CT-DTL250-W/M	19455	5905339194558	2 x max 10	blanc mat	bianco opaco	dans un axe	su un asse	30
SEIDY CT-DT050-W/M	19456	5905339194565	max 10	blanc mat	bianco opaco	dans un axe	su un asse	30
SEIDY CT-DT050-B/M	19457	5905339194572	max 10	mat noir	nero opaco	dans un axe	su un asse	30
SEIDY CT-DTL50-B/M	19458	5905339194589	max 10	mat noir	nero opaco	dans un axe	su un asse	30
SEIDY CT-DTL250-B/M	19459	5905339194596	2 x max 10	mat noir	nero opaco	dans un axe	su un asse	30

12 AC; 12 DC	Gx5,3	III	4	IP 20	5+25		0,12
0,75	0,5m		MR-16				

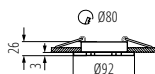

SEIDY CT-DT050

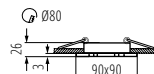

SEIDY CT-DTL50

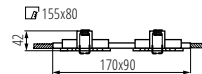

SEIDY CT-DTL250

Kanlux
SEIDY

SPOT ► FARETTO DECORATIVO ORIENTABILE



SEIDY CT-DT050-AL



SEIDY CT-DT050-B



SEIDY CT-DT050-W/M



SEIDY CT-DTL50-AL



SEIDY CT-DTL50-B



SEIDY CT-DTL50-W/M



SEIDY CT-DTL50-B/M



SEIDY CT-DTL250-B/M



SEIDY CT-DTL250-W/M



SIMEN DSO

SPOT ► FARETTO INCASSO



SIMEN DSO B/G



SIMEN DSO B/G	29137	5905339291370	max 10	noir / or nero / oro	non	non disponible
SIMEN DSO B/W	29138	5905339291387	max 10	noir / blanc nero / bianco	non	non disponible
SIMEN DSO W/B	29139	5905339291394	max 10	blanc / noir bianco / nero	non	non disponible
SIMEN DSO W/G	29140	5905339291400	max 10	blanc / or bianco / oro	non	non disponible
SIMEN DSO G/W	29142	5905339291424	max 10	or / blanc oro / bianco	non	non disponible

12 AC; 12 DC; 220-240 AC		Gx5,3/GU10		IP 20		5+25
Ø68	0,5m	MR16/PAR16				



SIMEN DSO B/W



SIMEN DSO W/G



SIMEN DSO G/W



SIMEN DSO W/B



Kanlux SIMEN est un luminaire composé de deux parties: une base et un corps. Nous proposons des gammes de couleurs classiques comme noir et blanc ou des luminaires contenant en versions argent et or, qui s'intégreront dans votre intérieur pour devenir une décoration à part entière. Vous pouvez personnaliser vous-même les éléments des luminaires Kanlux SIMEN.

Anneau décoratif sans douille céramique
Matériau du boîtier: alliage en aluminium

Kanlux SIMEN è un faretto di composto da due elementi: un anello e un corpo. Differenti combinazioni di colori disponibili: Bianco e nero oppure argento e oro. È inoltre possibile intercambiare gli elementi dei set con altri della stessa serie.

Faretto senza portalampada
Materiale del corpo: alluminio

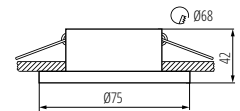

SIMEN DSO

SIMEN DSL

SPOT ► FARETTO INCASSO



SIMEN DSL SR/B/B



SIMEN DSL B/W/B	29131	5905339291318	max 10	noir / blanc / noir nero / bianco / nero	non	non disponible
SIMEN DSL SR/B/B	29132	5905339291325	max 10	argent / noir / noir argento / nero / nero	non	non disponible
SIMEN DSL B/G/B	29134	5905339291349	max 10	noir / or / noir nero / oro / nero	non	non disponible
SIMEN DSL W/G/W	29135	5905339291356	max 10	blanc / or / blanc bianco / oro / bianco	non	non disponible

12 AC; 12 DC; 220-240 AC		Gx5,3/GU10		IP 20		5+25
Ø68	0,5m	MR16/PAR16				



SIMEN DSL B/G/B



SIMEN DSL W/G/W



SIMEN DSL B/W/B



Kanlux SIMEN est un luminaire composé de trois parties: collerette, corps et base. Nous proposons des gammes de couleurs, classiques noir et blanc ou des luminaires contenant des décors argent et or, qui s'intégreront dans les intérieurs où ils deviendront une décoration à part entière. Vous pouvez également modifier vous-même les éléments des luminaires Kanlux SIMEN.

Anneau décoratif sans douille céramique
Matériau du boîtier: alliage en aluminium

Kanlux SIMEN è un faretto incasso composto da tre elementi: un anello, un corpo e una base. Differenti combinazioni di colori disponibili: Bianco e nero oppure argento e oro. È inoltre possibile intercambiare gli elementi dei set con altri della stessa serie Kanlux SIMEN disponibili.

Faretto senza portalampada
Materiale del corpo: alluminio

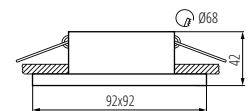

SIMEN DSL

Kanlux ALOR

SPOT ► FARETTO INCASSO



ALOR DSL-W

NEW



ALOR DSL-B



ALOR DTL-W

NEW



ALOR DTL-B



ALOR DSO-W

NEW



ALOR DSO-B



ALOR DTO-W

NEW



ALOR DTO-B

Kanlux ALOR est une famille de spots dans les couleurs les plus courantes : noir et blanc, avec une finition mate. Les luminaires ne sont pas livrés avec une douille en céramique. Vous pouvez utiliser une douille qui s'adapte à un culot GU10 ou Gx5.3, ce qui permet d'utiliser des sources lumineuses adaptées à l'installation.

Anneau décoratif sans douille céramique

Matériau du boîtier: acier

Kanlux ALOR è una famiglia di faretti da incasso disponibili nei colori bianco e nero, con una finitura opaca. Il design sobrio li rende adatti ad una moltitudine di ambienti. Possono essere abbinati a portalamapda gu10 o GX5.3

Portalamapda non incluso
Materiale del corpo: metallo



NEW	Model	Code	Power	Color	Finish	Notes	Height
NEW	ALOR DSL-W	26726	5905339267269	max 10	blanc mat bianco opaco	non non disponibile	
NEW	ALOR DSL-B	26727	5905339267276	max 10	mat noir nero opaco	non non disponibile	
NEW	ALOR DTL-W	26731	5905339267313	max 10	blanc mat bianco opaco	dans un axe su un asse	30
NEW	ALOR DTL-B	26732	5905339267320	max 10	mat noir nero opaco	dans un axe su un asse	30
NEW	ALOR DSO-W	26790	5905339267900	max 10	blanc mat bianco opaco	non non disponibile	
NEW	ALOR DSO-B	26791	5905339267917	max 10	mat noir nero opaco	non non disponibile	
NEW	ALOR DTO-W	26795	5905339267955	max 10	blanc mat bianco opaco	dans un axe su un asse	30
NEW	ALOR DTO-B	26796	5905339267962	max 10	mat noir nero opaco	dans un axe su un asse	30

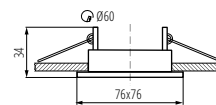

ALOR DSL

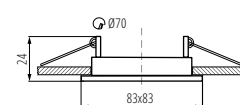

ALOR DTL

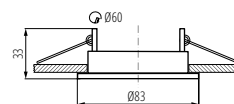

ALOR DSO

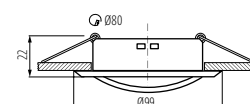

ALOR DTO

12 AC; 12 DC; 220-240 AC	IP 20	5+25	0,5m	MR16/PAR16	CE	UK CA	
--------------------------	-------	------	------	------------	----	-------	--

Kanlux ELNIS S

SPOT ► FARETTO INCASSO



ELNIS S W



ELNIS S W | **27800** | 5905339278005 | max 10 | blanc | bianco | non | non disponibile

[V] 12 AC; 12 DC; 220-240 AC								



Kanlux ELNIS est un luminaire composé de deux parties formant un ensemble. Il s'agit d'une combinaison de deux éléments séparés : le corps (partie principale) et le boîtier (bague), formant un ensemble parfaitement adapté. ELNIS S est un luminaire de 10 mm de hauteur. Kanlux ELNIS se caractérise par un design moderne et une très haute qualité de fabrication.

Anneau décoratif sans douille céramique
Matériau du boîtier: alliage en aluminium

Kanlux ELNIS S è un faretto dal design semplice ma originale. Disponibile nel colore bianco, può essere abbinato a lampade con attacco gu10 o mr16.

Faretto senza portalampada
Materiale del corpo: alluminio

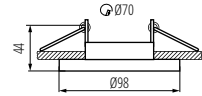

ELNIS S

Kanlux ELNIS L

SPOT ► FARETTO INCASSO



ELNIS L W/A



Kanlux ELNIS est un luminaire composé de deux parties formant un ensemble. Il s'agit d'une combinaison de deux éléments séparés : le corps (partie principale) et le boîtier (bague), formant un ensemble parfaitement adapté. ELNIS L est un appareil de 25 mm de hauteur. Kanlux ELNIS L se caractérise par un design moderne et très haute qualité de fabrication.

Anneau décoratif sans douille céramique
Matériau du boîtier: alliage en aluminium

Kanlux ELNIS è un faretto incasso composto da due parti che formano un insieme. Si tratta di una combinazione di due elementi separati: il corpo (la parte principale) e l'alloggiamento (l'anello distanziatore). ELNIS L ha uno spessore di 25 mm di altezza ed è disponibili in vari colori.

Faretto senza portalampada
Materiale del corpo: alluminio



ELNIS L W



ELNIS L W/C



ELNIS L A/C



ELNIS L A



ELNIS L B/G



ELNIS L W	27804	5905339278043	max 10	blanc bianco	non non disponibile
ELNIS L W/A	27805	5905339278050	max 10	blanc / anthracite bianco / antracite	non non disponibile
ELNIS L W/C	27806	5905339278067	max 10	blanc / chrome bianco / cromo	non non disponibile
ELNIS L A/C	27808	5905339278081	max 10	anthracite / chrome antracite / cromo	non non disponibile
ELNIS L A	27809	5905339278098	max 10	anthracite antracite	non non disponibile
ELNIS L B/G	27810	5905339278104	max 10	noir / or nero / oro	non non disponibile

[V] 12 AC; 12 DC; 220-240 AC								

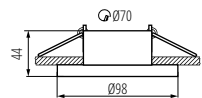

ELNIS L

Kanlux DALLA

SPOT ► FARETTO DECORATIVO ORIENTABILE



DALLA CT-DTL50-B



DALLA CT-DT050-W



DALLA CT-DTL50-W



DALLA CT-DT050-B



Kanlux DALLA est un luminaire très soigneusement fabriqué, destiné à être installé à l'intérieur. Il est doté d'un anneau mobile, ce qui permet de régler le faisceau lumineux. Ses formes et couleurs universelles permettent d'obtenir l'effet d'une élégance discrète et contemporaine.

Matériau du boîtier: alliage en aluminium

Kanlux DALLA è un faretto incasso per interni molto curato nei minimi dettagli. È orientabile e le sue forme e i suoi colori universali permettono di ottenere un effetto elegante e discreto.

Materiale del corpo: alluminio



DALLA CT-DT050-W	22430	5905339224309	max 10	blanc bianco	dans un axe su un asse	30
DALLA CT-DTL50-W	22431	5905339224316	max 10	blanc bianco	dans un axe su un asse	30
DALLA CT-DT050-B	22432	5905339224323	max 10	noir nero	dans un axe su un asse	30
DALLA CT-DTL50-B	22433	5905339224330	max 10	noir nero	dans un axe su un asse	30

[V] 12 AC; 12 DC	Gx5,3	III	IP 20	5+25	Ø70	0,12	0,75	0,5m	MR-16	CE	EAC	UK CA
[m] 0,12	[mm] 0,75	[m] 0,5m	[mm] Ø70	[mm] Ø82	[mm] 2,6	[mm] 0,12	[mm] 0,75	[m] 0,5m	[mm] MR-16	[mm] Ø70	[mm] Ø82	[mm] 2,6

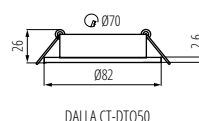

DALLA CT-DT050

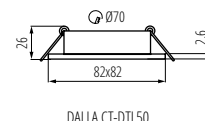

DALLA CT-DTL50

Kanlux SOREN

SPOT ► FARETTO DECORATIVO ORIENTABILE



SOREN O



SOREN L



SOREN O-SR VVV	24410	5905339244109	max 20	argent argento	non non disponibile
SOREN O-BL	24411	5905339244116	max 20	argent argento	non non disponibile
SOREN L-SR VVV	24413	5905339244130	max 20	argent argento	non non disponibile
SOREN L-BL	24414	5905339244147	max 20	argent argento	non non disponibile
SOREN O-SR CW	24416	5905339244161	max 20	argent argento	non non disponibile
SOREN L-SR CW	24417	5905339244178	max 20	argent argento	non non disponibile

[V] 220-240 AC	[Hz] 50	[W] 3,6	PAR16	GU10	SMD	≥15000	20000	IP 20	5+25	0,75+2,5	0,5m	CE	EAC	UK CA
[mm] Ø90	[mm] 90x90	[mm] 27	[mm] Ø90	[mm] 90x90	[mm] 27	[mm] 27	[mm] 27	[mm] Ø90	[mm] 90x90	[mm] 27	[mm] 27	[mm] Ø90	[mm] 90x90	[mm] 27

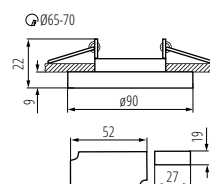

SOREN O

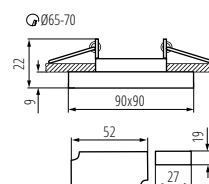

SOREN L



Kanlux SOREN sont des luminaires en verre qui présentent un atout supplémentaire sous forme d'une bande LED colorée et décorative, illuminant la base en verre du luminaire.

Matériau du boîtier: verre

Kanlux SOREN è una linea di faretti incasso corredati da striscia LED colorata e decorativa che ne illumina la base in vetro creando un piacevole effetto visivo.

Materiale del corpo: vetro

Kanlux ELICEO

SPOT ► FARETTO INCASSO



NEW

ELICEO DSO B



ELICEO DSO W/W



ELICEO DSO W/G



ELICEO DSO B/B



ELICEO-ST DSO W/W



ELICEO-ST DSO W/G



ELICEO-ST DSO B/B



ELICEO-ST DSO W

NEW



ELICEO-ST DSO YG

NEW



ELICEO-ST DSO GR

NEW



ELICEO-ST DSO PK

NEW



ELICEO-ST DSO BL

NEW



KANLUX GOVIK est un nouveau luminaire à encastrer avec une structure unique. L'utilisation d'un petit verre en acrylique permet de diffuser la lumière et rendre invisible la source lumineuse installée. Le luminaire ressemble à une minuscule applique en saillie intégrée.

Anneau décoratif sans douille céramique
Matériau du boîtier: alliage en aluminium

Kanlux GOVIK è un nuovo faretto da incasso dal design unico. Il paralume opaco in acrilico diffonde la luce e rende invisibile la sorgente luminosa.

Portalampana non incluso
Materiale del corpo: alluminio



ELICEO DSO B/B	35280	5905339352804	max 10	noir nero	non	non disponibile
ELICEO DSO W/W	35281	5905339352811	max 10	blanc bianco	non	non disponibile
ELICEO DSO W/G	35283	5905339352835	max 10	blanc / or bianco / oro	non	non disponibile
ELICEO-ST DSO B/B	35284	5905339352842	max 10	noir nero	non	non disponibile
ELICEO-ST DSO W/W	35285	5905339352859	max 10	blanc bianco	non	non disponibile
ELICEO-ST DSO W/G	35287	5905339352873	max 10	blanc / or bianco / oro	non	non disponibile
ELICEO DSO W	35288	5905339352880	max 10	blanc bianco	non	non disponibile
ELICEO DSO B	35289	5905339352897	max 10	noir nero	non	non disponibile
ELICEO DSO YG	35295	5905339352958	max 10	or oro	non	non disponibile
ELICEO DSO GR	35296	5905339352965	max 10	vert verde	non	non disponibile
ELICEO DSO PK	35297	5905339352972	max 10	rose rosa	non	non disponibile
ELICEO DSO BL	35298	5905339352989	max 10	bleu azzurro	non	non disponibile

12 AC; 12 DC; 220-240 AC	6x5.3/GU10	MR16/PAR16	IP 20	5+25
Ø68	0,5m	CE	UK CA	

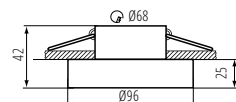

ELICEO DSO

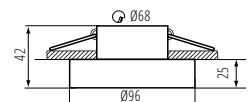

ELICEO-ST DSO

Kanlux MORTA

SPOT ► FARETTO DECORATIVO ORIENTABILE



MORTA CT-DSL50-B



MORTA CT-DSL50-SR



MORTA CT-DSO50-B



MORTA CT-DSO50-SR

DESIGN
unique

La large gamme de luminaires Kanlux MORTA permet la réalisation d'arrangements originaux dans chaque maison. Kanlux MORTA satisfera aux attentes de tous ceux qui apprécient les produits de haute qualité se caractérisant par un design attractif et original.

Matériau du boîtier: verre

Una vasta gamma di modelli di apparecchi Kanlux MORTA consente di creare arredamenti molto originali in ogni casa. Kanlux MORTA soddisferà le aspettative di tutti coloro che apprezzano i prodotti d'alta qualità, caratterizzati dal design attraente e originale.

Materiale del corpo: vetro



MORTA CT-DSL50-B	18510	5905339185105	max 10	noir nero	non non disponibile
MORTA CT-DSL50-SR	18512	5905339185129	max 10	argent argento	non non disponibile
MORTA CT-DSO50-B	19440	5905339194404	max 10	noir nero	non non disponibile
MORTA CT-DSO50-SR	19442	5905339194428	max 10	argent argento	non non disponibile

12 AC; 12 DC	Gx5,3			IP 20		5÷25		0,12
0,75	0,5m							

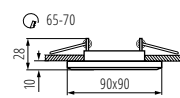

MORTA CT-DSL50

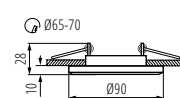

MORTA CT-DSO50

Kanlux MORTA DT

SPOT ► FARETTO INCASSO



MORTA CT-DTL50-B



MORTA CT-DTO50-SR



MORTA CT-DTO50-B



MORTA CT-DTL50-SR



DESIGN
unique

La large gamme de luminaires Kanlux MORTA permet la réalisation d'arrangements originaux dans chaque maison. Kanlux MORTA satisfera aux attentes de tous ceux qui apprécient les produits de haute qualité se caractérisant par un design attractif et original.

Anneau décoratif sans douille céramique

Matériau du boîtier: verre

Una vasta gamma di modelli di faretti Kanlux MORTA consente di creare combinazioni molto originali in ogni casa.

Porta lampada non incluso.

Materiale del corpo: vetro



MORTA CT-DTO50-SR	26716	5905339267160	max 10	argent argento	dans un axe su un asse	30
MORTA CT-DTO50-B	26717	5905339267177	max 10	noir nero	dans un axe su un asse	30
MORTA CT-DTL50-SR	26718	5905339267184	max 10	argent argento	dans un axe su un asse	30
MORTA CT-DTL50-B	26719	5905339267191	max 10	noir nero	dans un axe su un asse	30

12 AC; 12 DC; 220-240 AC	Gx5,3/GU10			IP 20		5÷25	
Ø75-80	0,5m						

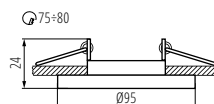

MORTA CT-DTO50-SR

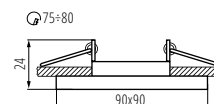

MORTA CT-DTL50

Kanlux

MORTA OCT

SPOT ► FARETTO INCASSO



MORTA OCT-SR



MORTA OCT-B



MORTA OCT-SR	26714	5905339267146	max 10	argent argento	non non disponibile
MORTA OCT-B	26715	5905339267153	max 10	noir nero	non non disponibile

[V]								
12 AC; 12 DC; 220-240 AC	Gx5,3/GU10	MR16/PAR16	CE	UK CA	IP 20	5+25	Ø60-65	0,5m

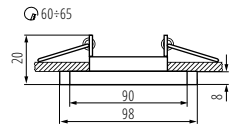

MORTA OCT

Kanlux

MORTA B

SPOT ► FARETTO DECORATIVO ORIENTABILE



MORTA B CT-DSL50-B



MORTA B CT-DSL50-SR



MORTA B CT-DSO50-B



MORTA B CT-DSO50-SR



MORTA B CT-DSL50-B	22110	5905339221100	max 10	noir nero	non non disponibile
MORTA B CT-DSL50-SR	22112	5905339221124	max 10	argent argento	non non disponibile
MORTA B CT-DSO50-B	22116	5905339221162	max 10	noir nero	non non disponibile
MORTA B CT-DSO50-SR	22117	5905339221179	max 10	argent argento	non non disponibile

[V]								
12 AC; 12 DC	Gx5,3	MR-16	CE	UK CA	IP 20	5+25	Ø65-70	0,12
0,12	0,75	0,5m	MR-16	IP 20	5+25	Ø65-70	0,12	0,75

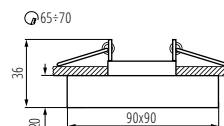

MORTA B CT-DSL50

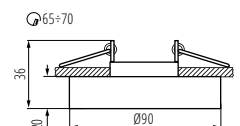

MORTA B CT-DSO50



La large gamme de luminaires Kanlux MORTA permet la réalisation d'arrangements originaux dans chaque maison. Kanlux MORTA satisfera aux attentes de tous ceux qui apprécient les produits de haute qualité se caractérisant par un design attractif et original.

Anneau décoratif sans douille céramique
Matériau du boîtier: verre

Una vasta gamma di modelli di faretto Kanlux MORTA consente di creare combinazioni molto originali in ogni casa. Kanlux MORTA soddisfano le aspettative di tutti coloro che apprezzano i prodotti d'alta qualità, caratterizzati dal design attraente e originale.

Portallampada non incluso
Materiale del corpo: vetro



La large gamme de luminaires Kanlux MORTA permet la réalisation d'arrangements originaux dans chaque maison. Kanlux MORTA satisfera aux attentes de tous ceux qui apprécient les produits de haute qualité se caractérisant par un design attractif et original.

Matériau du boîtier: verre

Una vasta gamma di modelli di apparecchi Kanlux MORTA consente di creare arredamenti molto originali in ogni casa. Kanlux MORTA soddisfano le aspettative di tutti coloro che apprezzano i prodotti d'alta qualità, caratterizzati dal design attraente e originale.

Materiale del corpo: vetro

Kanlux IVRI

SPOT ► FARETTO INCASSO



IVRI DTO-W



IVRI DTO-W | **26736** | 5905339267368 | max 10 | blanc | bianco | dans un axe | su un asse | 30

IVRI						
12 AC; 12 DC; 220-240 AC		Gx5.3/GU10		IP 20		5+25
Ø83	0,5m	MR16/PAR16				



Kanlux IVRI est une gamme d'anneaux de décoration, fabriqués en aluminium. Kanlux IVRI est expressif dans ses formes, il permet également de régler la direction de la lumière dans une gamme de 30 degrés.

Anneau décoratif sans douille céramique

Matériau du boîtier: alliage en aluminium

Kanlux IVRI sono faretto decorativi ad incasso realizzati in alluminio verniciato di bianco. Sono orientabili di 30° e compatibili con lampade gu10 o mr16.

Portalamapda non incluso

Materiale del corpo: alluminio

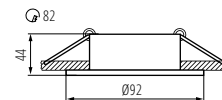

IVRI DTO

Kanlux ARET

SPOT ► FARETTO INCASSO



ARET 1XM16-W



ARET 2XM16-W



ARET 1XM16-W | **26720** | 5905339267207 | max 10 | blanc | bianco | dans un axe | su un asse | 20
ARET 2XM16-W | **26723** | 5905339267238 | 2 x max 10 | blanc | bianco | dans un axe | su un asse | 20

IVRI						
12 AC; 12 DC; 220-240 AC		Gx5.3/GU10		IP 20		5+25
	0,5m	MR16/PAR16				



La gamme de luminaires Kanlux ARET sont des spots anneaux décoratifs, fabriqués en alliage d'aluminium et tôles d'acier. Ces points lumineux sont vendus sans boîtier: ils peuvent être associés à des boîtiers GZ10 ou GX5.3. Ceci permet d'adapter la source lumineuse au type d'installation prévu pour une pièce donnée. Les luminaires Kanlux ARET seront parfaits dans la fonction d'éclairage supplémentaire, aussi bien dans les habitations que dans des bars ou restaurants: partout où nous voulons accentuer un arrangement intéressant de la pièce ou mettre en évidence un élément.

Anneau décoratif sans douille céramique

Matériau du boîtier: alliage en aluminium

La famiglia di faretto incasso Kanlux ARET è realizzata in alluminio. Questi spot sono privi di portalamapda, è possibile abbinarvi un portalamapda GZ10 o GX5.3. Kanlux ARET sono ideali tanto in ambienti domestici che commerciali.

Decorazione ad anello senza cornice in ceramica

Materiale del corpo: alluminio

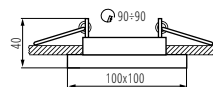

ARET 1XM16

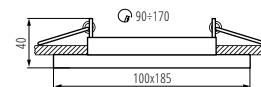

ARET 2XM16

ALREN R

SPOT ► FARETTO INCASSO



ALREN R DTL-W



ALREN R DTL-B



ALREN R DTL-B	26757	5905339267573	max 10	noir nero	dans deux axes	su due assi	60/60
ALREN R DTL-W	26758	5905339267580	max 10	blanc bianco	dans deux axes	su due assi	60/60

[V] 12 AC; 12 DC; 220-240 AC	 Gx5,3/GU10	 6x5,3/GU10	 60°	 0,5m	 MR16/PAR16	 IP 20	 5+25			
--	----------------	----------------	---------	----------	----------------	-----------	----------	--	--	--

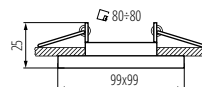

ALREN R DTL

ALREN

SPOT ► FARETTO INCASSO



ALREN DTL-W



ALREN DTL-B



ALREN DTL-C-M



ALREN DTL-W	26753	5905339267535	max 35	blanc mat bianco opaco	dans un axe	su un asse	15
ALREN DTL-B	26754	5905339267542	max 35	mat noir nero opaco	dans un axe	su un asse	15
ALREN DTL-C/M	26756	5905339267566	max 35	chrome mat cromato opaco	dans un axe	su un asse	15

[V] 12 AC; 12 DC; 220-240 AC	 Gx5,3/GU10	 6x5,3/GU10	 83x83	 0,5m	 MR16/PAR16	 IP 20	 5+25			
--	----------------	----------------	-----------	----------	----------------	-----------	----------	--	--	--

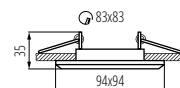

ALREN DTL



Le modèle de cadres décoratifs Kanlux ALREN R constitue un luminaire remarquable, sans équivalent sur ce segment des formes de luminaires - des spots massifs à coins arrondis. La possibilité d'orientation de 60 degrés sur deux plans est un avantage incontestable. Les Kanlux ALREN R sont proposés sans cadre.

Anneau décoratif sans douille céramique

Matériau du boîtier: alliage en aluminium

I Kanlux ARLEN R sono faretto ad incasso orientabili. Sono disponibili nei colori nero o bianco. Sono interamente realizzati in alluminio e hanno un design sobrio ed elegante.

Decorazione ad anello senza cornice in ceramica

Materiale del corpo: alluminio



Les anneaux décoratifs Kanlux ALREN sont vendus sans boîtier: ils peuvent être associés à des boîtiers GU10 ou GX5.3. Les plafonniers encastrés seront parfaits dans la fonction d'éclairage supplémentaire, dans les habitations, dans des bars ou restaurants: partout où nous voulons accentuer un arrangement intéressant de la pièce ou mettre en évidence un élément.

Anneau décoratif sans douille céramique

Matériau du boîtier: alliage en aluminium

I Kanlux ARLEN sono faretto incasso orientabili. Sono disponibili nei colori nero o bianco. Sono interamente realizzati in alluminio e hanno una forma quadrata. Ideali per ambienti domestici e commerciali.

Decorazione ad anello senza cornice in ceramica

Materiale del corpo: alluminio

Kanlux COLIE

SPOT ► FARETTO INCASSO



COLIE DTO-G



COLIE DTO-W



COLIE DTO-B



COLIE DTO-GR



Les anneaux décoratifs Kanlux COLIE permettent la réalisation d'arrangements originaux dans chaque maison. Ils se caractérisent par une forme élégante et originale, en assurant en même temps une distribution discrète de la lumière. La gamme COLIE est destinée à être encastrée dans le plafond. Ces luminaires seront parfaits dans la fonction d'éclairage supplémentaire, aussi bien dans les habitations que dans des bars ou restaurants: partout où nous voulons accentuer un arrangement intéressant de la pièce.

Anneau décoratif sans douille céramique
Matériau du boîtier: alliage en aluminium

I faretti incasso decorativi Kanlux COLIE consentono di creare scenari molto originali in ogni casa. Sono caratterizzati dal design elegante e originale, garantendo allo stesso tempo una diffusione discreta della luce. La serie COLIE è progettata per essere incassata nei soffitti.

Decorazione ad anello senza cornice in ceramica
Materiale del corpo: alluminio



COLIE DTO-W	26740	5905339267405	max 10	blanc mat bianco opaco	dans un axe su un asse	15
COLIE DTO-G	26741	5905339267412	max 10	or anodisé oro anodizzato	dans un axe su un asse	15
COLIE DTO-B	26743	5905339267436	max 10	mat noir nero opaco	dans un axe su un asse	15
COLIE DTO-GR	26744	5905339267443	max 10	gris grigio	dans un axe su un asse	15

12 AC; 12 DC; 220-240 AC												
Ø75	0,5m	6x5,3/GU10	MR16/PAR16	CE	UK	CA	IP 20	5+25	5+25	5+25	5+25	5+25

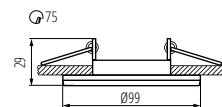

COLIE DTO

Kanlux NESTA

SPOT ► FARETTO INCASSO



NESTA DSL-C



NESTA DSL-C/M



NESTA DTL-C



NESTA DTL-C/M

Les points lumineux Kanlux NESTA sont disponibles dans une version avec un anneau mobile permettant de diriger le faisceau lumineux dans la direction voulue et dans une version avec un anneau fixe. Les luminaires destinés à être encastrés au plafond sont parfaits dans la fonction d'éclairage supplémentaire, aussi bien dans les habitations que dans les bars et restaurants: partout où nous voulons accentuer un arrangement intéressant de la pièce. Assemblés dans un groupe, ces luminaires peuvent aussi constituer l'éclairage principal.

Anneau décoratif sans douille céramique
Matériau du boîtier: alliage en aluminium

I faretti incasso Kanlux NESTA sono disponibili nella versione fissa o orientabile ed in diversi colori. Sono interamente realizzati in metallo e hanno una forma quadrata con angoli stondati.

Decorazione ad anello senza cornice in ceramica
Materiale del corpo: alluminio

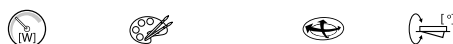

NESTA DSL-C	26747	5905339267474	max 10	chrome cromo	non non disponibile	
NESTA DSL-C/M	26748	5905339267481	max 10	chrome mat cromato opaco	non non disponibile	
NESTA DTL-C	26751	5905339267511	max 10	chrome cromo	dans un axe su un asse	30
NESTA DTL-C/M	26752	5905339267528	max 10	chrome mat cromato opaco	dans un axe su un asse	30

12 AC; 12 DC; 220-240 AC												
5+25	0,5m	6x5,3/GU10	MR16/PAR16	CE	UK	CA	IP 20	5+25	5+25	5+25	5+25	5+25

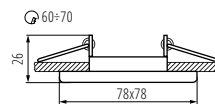

NESTA DSL

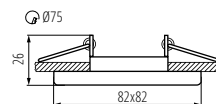

NESTA DTL

Kanlux EVIT

SPOT ► FARETTO DECORATIVO ORIENTABILE



EVIT CT-DTL50



EVIT CT-DT050



EVIT CT-DTL50-AL	18560	5905339185600	max 10	aluminium alluminio	dans un axe su un asse	30
EVIT CT-DT050-AL	18561	5905339185617	max 10	aluminium alluminio	dans un axe su un asse	30

				IP 20				
12 AC; 12 DC	Gx5,3	III		20		5+25	Ø70-75	
0,12	0,75	0,5m	MR-16	CE	EAC	UK	CA	

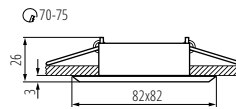

EVIT CT-DTL50

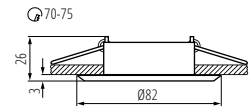

EVIT CT-DT050

Kanlux GWEN

SPOT ► FARETTO DECORATIVO ORIENTABILE



GWEN CT-DT050



GWEN CT-DTL50



GWEN CT-DTL50-B	18530	5905339185303	max 10	noir anodisé nero anodizzato	dans un axe su un asse	30
GWEN CT-DT050-B	18531	5905339185310	max 10	noir anodisé nero anodizzato	dans un axe su un asse	30

				IP 20				
12 AC; 12 DC	Gx5,3	III		20		5+25	Ø70-75	
0,12	0,75	0,5m	MR-16	CE	EAC	UK	CA	

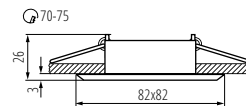

GWEN CT-DTL50

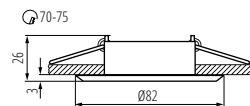

GWEN CT-DT050

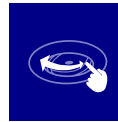

Kanlux EVIT est un point lumineux fabriqué en aluminium. Il permet de régler la direction du flux lumineux. Kanlux EVIT est un spot classique sans éléments de décoration.

Matériau du boîtier: alliage en aluminium

Kanlux EVIT è uno spot classico in cui non è visibile la molla ritentiva della lampadina.

Materiale del corpo: alluminio

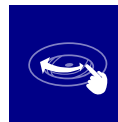

Kanlux GWEN est un spot qui s'intègre parfaitement dans les espaces élégants et sobres. L'aluminium brossé de couleur noire ajoutera une touche chic à l'espace éclairé.

Matériau du boîtier: alliage en aluminium

Kanlux GWEN è un faretto che si inserisce alla perfezione in interni eleganti e sobri. L'alluminio spazzolato nero aggiunge un tocco di glamour agli interni.

Materiale del corpo: alluminio

Kanlux LUTO

SPOT ► FARETTO DECORATIVO ORIENTABILE



LUTO CTX-DS02B-W



LUTO CTX-DS02B-C/M



LUTO CTX-DS02B-AB



LUTO CTX-DT02B-W



LUTO CTX-DT02B-C

Kanlux LUTO est une gamme de points lumineux classiques dans des couleurs discrètes. Le blanc, le cuivre patiné ou le chrome mat ajouteront une touche de charme non seulement aux espaces domestiques, mais aussi aux hôtels et restaurants.

Matériau du boîtier: alliage en aluminium

Kanlux LUTO è una linea di faretti incasso tradizionali dai colori sobri. L'ottone spazzolato, il bianco o il cromo opaco aggiungono discretamente fascino non solo agli spazi domestici ma anche agli alberghi e alle caffetterie.

Materiale del corpo: alluminio



LUTO CTX-DS02B-W	02580	5905339025807	max 10	blanc bianco	non non disponibile
LUTO CTX-DS02B-C/M	02583	5905339025838	max 10	chrome mat cromato opaco	non non disponibile
LUTO CTX-DS02B-AB	02584	5905339025845	max 10	laiton mat ottone opaco	non non disponibile
LUTO CTX-DT02B-W	02590	5905339025906	max 10	blanc bianco	dans un axe su un asse 15
LUTO CTX-DT02B-C	02591	5905339025913	max 10	chrome cromo	dans un axe su un asse 15

				IP 20				
12 AC; 12 DC	Gx5,3			20		5+25		0,12
0,75	0,5m	MR-16						

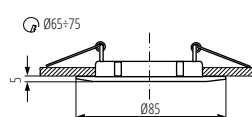

LUTO CTX-DS02B

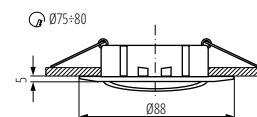

LUTO CTX-DT02B

Kanlux NAVI

SPOT ► FARETTO DECORATIVO ORIENTABILE



NAVI CTX-DT10-W



NAVI CTX-DT10-C/M



NAVI CTX-DS10-B



NAVI CTX-DT10-B

Kanlux NAVI est une gamme de luminaires variés, simples dans leurs forme, qui offrent différentes possibilités d'application.

Matériau du boîtier: alliage en aluminium

I Kanlux NAVI sono faretti dalla forma semplice. Disponibili in molti colori sia nel formato orientabile che fisso.

Materiale del corpo: alluminio



NAVI CTX-DT10-W	02550	5905339025500	max 10	blanc bianco	dans un axe su un asse 15
NAVI CTX-DT10-C/M	02553	5905339025531	max 10	chrome mat cromato opaco	dans un axe su un asse 15
NAVI CTX-DS10-B	25990	5905339259905	max 10	mat noir nero opaco	non non disponibile
NAVI CTX-DT10-B	25991	5905339259912	max 10	mat noir nero opaco	dans un axe su un asse 15

				IP 20				
12 AC; 12 DC	Gx5,3			20		5+25		0,12
0,75	0,5m	MR-16						

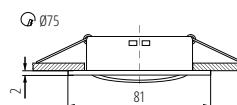

NAVI CTX-DT10

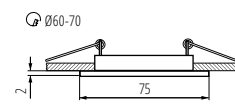

NAVI CTX-DS10

Kanlux

VIDI

SPOT ► FARETTO DECORATIVO ORIENTABILE



VIDI CTC-5515-W



VIDI CTC-5514-C/M



VIDI CTC-5514-B



VIDI CTC-5514-W



VIDI CTC-5514-C



VIDI CTC-5515-C/M



VIDI CTC-5515-B

Kanlux VIDI est un spot de forme classique, en aluminium avec différentes couleurs de finition.

Matériau du boîtier: alliage en aluminium

Kanlux VIDI è una famiglia di diversi faretti incasso dalla forma semplice. È possibile scegliere tra molti colori.

Materiale del corpo: alluminio



VIDI CTC-5515-W	02780	5905339027801	max 10	blanc bianco	dans un axe su un asse	15
VIDI CTC-5515-C	02781	5905339027818	max 10	chrome cromo	dans un axe su un asse	15
VIDI CTC-5515-C/M	02783	5905339027832	max 10	chrome mat cromato opaco	dans un axe su un asse	15
VIDI CTC-5514-W	02790	5905339027900	max 10	blanc bianco	non non disponibile	
VIDI CTC-5514-C	02791	5905339027917	max 10	chrome cromo	non non disponibile	
VIDI CTC-5514-C/M	02793	5905339027931	max 10	chrome mat cromato opaco	non non disponibile	
VIDI CTC-5514-B	25995	5905339259950	max 10	mat noir nero opaco	non non disponibile	
VIDI CTC-5515-B	25996	5905339259967	max 10	mat noir nero opaco	dans un axe su un asse	15

12 AC; 12 DC	Gx5,3	III	↕	IP 20	5+25	0,12
0,75	0,5m	MR-16				

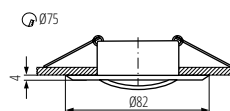

VIDI CTC-5515

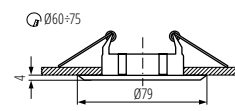

VIDI CTC-5514

Kanlux RADAN

SPOT ► FARETTO DECORATIVO ORIENTABILE



RADAN CT-DT050



RADAN CT-DS050

Kanlux RADAN sont des spots simples qui éclaireront chaque espace. Nous pouvons choisir nous-mêmes la source lumineuse et la version du luminaire : avec réglage ou fixe.

Matériau du boîtier: alliage en aluminium

Kanlux RADAN sono spot semplici che illumineranno qualsiasi ambiente. È possibile scegliere in piena autonomia sia la sorgente luminosa che la versione dell'apparecchio, fisso o regolabile.

Materiale del corpo: alluminio



RADAN CT-DT050	07360	5905339073600	max 10	aluminium alluminio	dans un axe su un asse	30
RADAN CT-DS050	07362	5905339073624	max 10	aluminium alluminio	non non disponibile	

[V] 12 AC; 12 DC	Gx5,3	III	IP 20	5+25	0,12
0,75	0,5m	MR-16	CE	ERC	UK CA

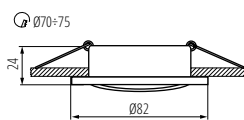

RADAN CT-DT0

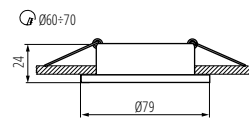

RADAN CT-DS0

Kanlux TESON

SPOT ► FARETTO DECORATIVO ORIENTABILE



TESON AL-DL50



TESON AL-DTL50



TESON AL-DS050

Kanlux TESON sont des points lumineux simples qui éclaireront chaque espace. Nous pouvons choisir nous-mêmes la source lumineuse et la version du luminaire : avec réglage ou fixe.

Matériau du boîtier: alliage en aluminium

Kanlux TESON sono spot semplici che illumineranno qualsiasi ambiente. È possibile scegliere in piena autonomia sia la sorgente luminosa che la versione dell'apparecchio, fisso o regolabile.

Materiale del corpo: alluminio

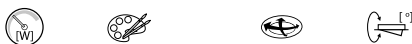

TESON AL-DTL50	07371	5905339073716	max 10	aluminium alluminio	dans un axe su un asse	30
TESON AL-DS050	07372	5905339073723	max 10	aluminium alluminio	non non disponibile	
TESON AL-DL50	07373	5905339073730	max 10	aluminium alluminio	non non disponibile	

[V] 220-240 AC	[Hz] 50	GU10	IP 20	5+25	0,12
0,75x2,5	0,5m	PAR16	CE	ERC	UK CA

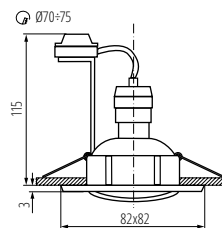

TESON AL-DTL

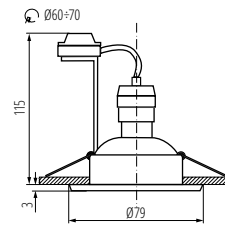

TESON AL-DS0

Kanlux HORN

SPOT ► FARETTO DECORATIVO ORIENTABILE



HORN CTC-3114

La vaste gamme des spots Kanlux HORN, très demandés, offre aussi bien des modèles classiques que des combinaisons de couleurs audacieuses. Chacun y trouvera un modèle parfaitement adapté à son intérieur.

Matériau du boîtier: acier

Kanlux HORN è una famiglia molto ampia di spot da incasso, a partire dai modelli classici fino ad arrivare a combinazioni di colori audaci.

Materiale del corpo: metallo



HORN CTC-3114-GM/N	02824	5905339028242	max 10	graphite / nickel grafite/nichel	non non disponibile	
--------------------	--------------	---------------	--------	------------------------------------	-----------------------	--

[V] 12 AC; 12 DC	Gx5,3	III	IP 20	5+25	0,12
0,75	0,5m	MR-16	CE	ERC	UK CA

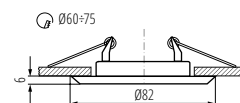

HORN CTC-3114

Kanlux

ARGUS II

SPOT ► FARETTO INCASSO



ARGUS II CT-2114-C



ARGUS II CT-2114-W



ARGUS II CT-2114-C/M



ARGUS II CT-2114-AN



ARGUS II CT-2114-BR/M



ARGUS II CT-2114-GM



ARGUS II CT-2115-C



ARGUS II CT-2115-W



ARGUS II CT-2115-C/M



ARGUS II CT-2115-AN



ARGUS II CT-2115-BR/M



ARGUS II CT-2115-GM



ARGUS II CT-2115-G



TRIBIS II

SPOT ► SET DI FARETTI INCASSO COMPLETI DI LAMPADE



TRIBIS II O B

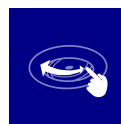

Kit 3 Spots encastrables avec source lumineuse TRIBIS II: des anneaux décoratifs, des sources lumineuses et des douilles céramique avec un support. Vous pouvez choisir entre deux formes (carrée et ronde) et plusieurs coloris. Les spots Kanlux TRIBIS II ont la possibilité de régler l'angle de 50° afin que vous puissiez facilement les diriger dans la direction souhaitée. Les spots TRIBIS II, conçus pour être encastrés dans le plafond, sont parfaits comme éclairage principal ou complémentaire. Vous pouvez les placer dans un ensemble ou les répartir sur plusieurs endroits.

Matériau du boîtier: acier

Kanlux TRIBIS II è un set completo di 3 faretti incasso, composto da i seguenti elementi: faretti incasso, lampade led e portalampada ceramici. E' possibile scegliere tra due forme (quadrata e tonda) e diverse varianti di colore. I faretti Kanlux TRIBIS II possono essere orientati di 50°, così da poter indirizzare la luce a piacere. I faretti Kanlux TRIBIS II sono perfetti come illuminazione principale o ausiliaria.

Materiale del corpo: metallo



TRIBIS II L AB	23843	5905339238436	3 x max 10	patinated brass	dans un axe su un asse	50
TRIBIS II L C	23844	5905339238443	3 x max 10	chrome cromo	dans un axe su un asse	50
TRIBIS II L C/M	23845	5905339238450	3 x max 10	chrome mat cromato opaco	dans un axe su un asse	50
TRIBIS II O AB	23846	5905339238467	3 x max 10	patinated brass	dans un axe su un asse	50
TRIBIS II O C	23847	5905339238474	3 x max 10	chrome cromo	dans un axe su un asse	50
TRIBIS II O C/M	23848	5905339238481	3 x max 10	chrome mat cromato opaco	dans un axe su un asse	50
TRIBIS II L W	23849	5905339238498	3 x max 10	blanc bianco	dans un axe su un asse	50
TRIBIS II L B	23853	5905339238535	3 x max 10	noir nero	dans un axe su un asse	50
TRIBIS II O W	23854	5905339238542	3 x max 10	blanc bianco	dans un axe su un asse	50
TRIBIS II O B	23855	5905339238559	3 x max 10	noir nero	dans un axe su un asse	50

[V] 220-240 AC	[Hz] 50	GU10	IP 20	PAR16 LED	SMD
5+25	0,75+2,5	0,5m	PAR16 LED	SMD	
4,9	400	120°	Tc [K] 3000	ellipse ≤ 6° MacAdam	Ra 80
25000	CE	ErC	UK CA		

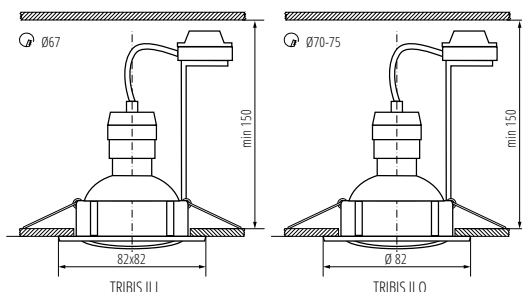

Kanlux

TRIBIS II

SPOT ► SET DI FARETTI INCASSO COMPLETI DI LAMPADINE



TRIBIS II L AB



TRIBIS II L C



TRIBIS II L C/M



TRIBIS II L W



TRIBIS II L B



TRIBIS II O C/M



TRIBIS II O AB



TRIBIS II O C



TRIBIS II O W



DROXY IP65

SPOT ► FARETTO INCASSO



Kanlux DROXY IP65 est une famille d'anneaux décoratifs adaptés aux salles de bains et aux pièces à forte humidité (IP65/20). Cette famille se compose de 2 modèles ronds. Ils se distinguent par leur surface décorative, parfaitement lisse, qui, associée aux couleurs mates (blanc et noir), donne un effet à la fois élégant et discret à la pièce ou ils sont instal

Anneau décoratif sans douille céramique
Matériau du boîtier: alliage en aluminium

Kanlux DROXY IP65 è una nuova famiglia faretti incasso dedicata ai bagni e alle stanze in cui è presente umidità (IP65 / 20). Si caratterizza per il design semplice e minimalista ed è composta di ue modelli rotondi (DSO). Disponibile in due colori: bianco opaco e nero opaco.

Faretto senza portalampada
Materiale del corpo: alluminio



DROXY IP65 DSO-W



DROXY IP65 DSO-B



DROXY IP65 DSO-W	33125	5905339331250	max 10	blanc bianco	non	non disponibile
DROXY IP65 DSO-B	33126	5905339331267	max 10	noir nero	non	non disponibile

[V] 12 AC; 12 DC; 220-240 AC				

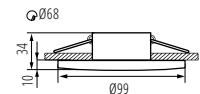

DROXY IP65 DSO

FLINI IP44

SPOT ► FARETTO INCASSO



Kanlux FLINI sont des luminaires dédiés aux salles de bain et pièces humides. Grâce à leur conception étanche, ils sont résistants à l'humidité (IP44). Les Kanlux FLINI sont disponible en deux formes - ronde et carré. Vous pouvez choisir entre blanc mat ou noir mat. Ces couleurs universelles permetts de les installer dans quasiment tous les intérieurs.

Anneau décoratif sans douille céramique
Matériau du boîtier: alliage en aluminium

Kanlux FLINI è una serie di faretti da incasso dedicata ai bagni e agli ambienti umidi. Sono resistenti all'umidità (IP44), e disponibili in due forme - rotonda e quadrata. È possibile scegliere tra il bianco opaco o il nero opaco, due colori così universali ci permetteranno di abbinare questi faretti a quasi tutti gli interni.

Faretto senza portalampada
Materiale del corpo: alluminio



FLINI IP44 DSL-W



FLINI IP44 DSL-B



FLINI IP44 DSO-B



FLINI IP44 DSO-W



FLINI IP44 DSL-B	33120	5905339331205	max 10	noir nero	non	non disponibile
FLINI IP44 DSL-W	33121	5905339331212	max 10	blanc bianco	non	non disponibile
FLINI IP44 DSO-B	33122	5905339331229	max 10	noir nero	non	non disponibile
FLINI IP44 DSO-W	33123	5905339331236	max 10	blanc bianco	non	non disponibile

[V] 12 AC; 12 DC; 220-240 AC				

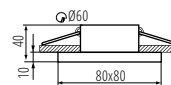

FLINI IP44 DSL

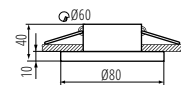

FLINI IP44 DSO

Kanlux QULES

SPOT ► FARETTO DECORATIVO ORIENTABILE



QULES AC O-W



QULES AC O-C/M



QULES AC O-B



QULES AC O-W	26303	5905339263032	max 10	blanc bianco	non	non disponibile
QULES AC O-C/M	26304	5905339263049	max 10	chrome mat cromato opaco	non	non disponibile
QULES AC O-B	26306	5905339263063	max 10	noir nero	non	non disponibile

[V] 220-240 AC	[Hz] 50	GU10			IP 44/20		 -20+35	 Ø71-74
	 0,5m		PAR16	CE	ERAC	UK CA		

IP
44/20

Les points Kanlux QULES appartiennent aux luminaires les plus demandés avec un indice IP élevé. Ils sont parfaits pour l'installation dans la salle de bains ou dans d'autres pièces à humidité élevée.

Matériau du boîtier: alliage en aluminium

Gli spot da soffitto Kanlux QULES sono uno degli apparecchi più diffusi con l'elevato grado IP. Sono perfetti per il montaggio in bagno oppure in altri luoghi caratterizzati da un livello di umidità più elevato.

Materiale del corpo: alluminio

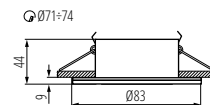

QULES AC O

Kanlux MARIN

SPOT ► FARETTO DECORATIVO ORIENTABILE



MARIN CT-S80-C



MARIN CT-S80-B



MARIN CT-S80-SN



MARIN CT-S80-AB



MARIN CT-S80-W



MARIN CT-S80-C	04703	5905339047038	max 10	chrome cromo	non	non disponibile
MARIN CT-S80-SN	04704	5905339047045	max 10	nickel mat nichel opaco	non	non disponibile
MARIN CT-S80-AB	04710	5905339047106	max 10	laiton mat ottone opaco	non	non disponibile
MARIN CT-S80-W	32500	5905339325006	max 10	blanc bianco	non	non disponibile
MARIN CT-S80-B	32501	5905339325013	max 10	mat noir nero opaco	non	non disponibile

[V] 12 AC; 12 DC	Gx5,3			IP 44/20		 Ø60-62		 0,12
 0,75	 0,5m		MR-16	CE	ERAC	UK CA		

IP
44/20

Kanlux MARIN sont des luminaires pour plafonds, étanches et de petites dimensions qui peuvent être utilisés dans des endroits à humidité élevée. Nous pouvons facilement les utiliser dans la salle de bains au-dessus du miroir, dans la cuisine ou dans la buanderie.

Matériau du boîtier: acier

Kanlux MARIN sono piccoli faretti a tenuta stagna da soffitto che possono essere impiegati in luoghi con umidità più elevata. Possono essere liberamente utilizzati in bagno sopra lo specchio, in cucina o in lavanderia.

Materiale del corpo: metallo

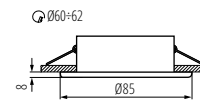

MARIN CT

Kanlux

IMBER LED

SPOT À ENCASTRER ► FARETTO INCASSO LED



IMBER LED



IMBER LED NW	23520	5905339235206	1	aluminium alluminio	40	105	4000
IMBER LED CW	23521	5905339235213	1	aluminium alluminio	40	105	6500
IMBER LED VW	23522	5905339235220	1	aluminium alluminio	40	105	3000

[V]	[h]	[h]	Alipse ≤ 6x Macchidan	Ra 80	SMD	III	IP 65	House icon
12 AC; 12 DC	≥20000	30000						
Temperature icon -20+50	House icon	Wiring icon	Drill icon Ø27	Distance icon 0,1m	CE	ERAC	UK	Recycling icon

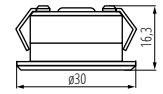

IMBER LED

Kanlux

OYO

LUMINAIRE LED ► ILLUMINAZIONE D'ACCENTO LED



OYO SLED



OYO SLED-CW	08121	5905339081216	0,22	chrome cromo	5	15	6500
-------------	-------	---------------	------	----------------	---	----	------

[V]	[h]	[h]	III	IP 68	House icon	Wiring icon	[mm]
12 DC	30000						0,2
Drill icon Ø8	Distance icon 0,1m	Wiring icon W 23	CE	ERAC	UK	Recycling icon	

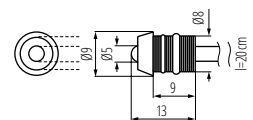

OYO SLED



Kanlux IMBER LED est un luminaire étanche de type spot à encastrer. Un de ses atouts est la température de travail basse, ce qui permet de l'installer sans problème dans le bois. La forme unique du luminaire assure une diffusion uniforme de lumière et les diodes LED utilisées garantissent une efficacité énergétique importante. Le luminaire Kanlux IMBER LED est une excellente solution pour illuminer les cabines de douche et les revêtements de pignons à l'extérieur des maisons.

Matériau du boîtier: alliage en aluminium
Matériau du diffuseur: matériau plastique

Kanlux IMBER LED è un faretto incasso a tenuta stagna. Uno dei suoi vantaggi è la bassa temperatura d'esercizio che lo rende ideale da montare senza alcun ostacolo anche sul legno. La costruzione dell'apparecchio unica nel suo genere si traduce in un'uniforme emissione luminosa, e l'impiego dei LED garantisce bassi consumi energetici. Kanlux IMBER LED ha un grado Ip 65 ed è disponibile con luce neutra o fredda.

Materiale del corpo: alluminio
Diffusore: plastica



Kanlux OYO LED sont des points lumineux d'accentuation, parfaits comme éclairage décoratif. Ces points lumineux de petites dimensions nous aideront à réaliser des projets d'éclairage audacieux également dans des saunas et salles de bains, grâce à leur indice d'étanchéité élevé, IP68.

OYO SLED-CW 5 pcs
Matériau du boîtier: métal, matériau plastique

Kanlux OYO LED sono microfaretto luminosi da utilizzare come illuminazione decorativa. Questi piccoli faretto aiutano a realizzare audaci progetti d'illuminazione anche in saune o bagni grazie all'elevato grado di protezione IP68.

Materiale del corpo: metallo, plastica

Kanlux

ASTIM LED IP44

LUMINAIRE MURAL LED ▶ LAMPADA DA PARETE LED



ASTIM IP44 8W-NW-B



ASTIM IP44 8W-NW-C



ASTIM IP44 8W-NW-W



ASTIM IP44 12W-NW-B



ASTIM IP44 12W-NW-W



ASTIM IP44 12W-NW-C



ASTIM IP44 8W-NW-B	34930	5905339349309	8	noir nero	590	4000
ASTIM IP44 8W-NW-W	34931	5905339349316	8	blanc bianco	690	4000
ASTIM IP44 8W-NW-C	34932	5905339349323	8	chrome cromo	660	4000
ASTIM IP44 12W-NW-B	34933	5905339349330	12	noir nero	910	4000
ASTIM IP44 12W-NW-W	34934	5905339349347	12	blanc bianco	1070	4000
ASTIM IP44 12W-NW-C	34935	5905339349354	12	chrome cromo	1010	4000

[V] 220-240 AC	[Hz] 50	[mm] 0,75+1,5	[h] ≥15000	[h] 25000	[lm] ≤6xMacadam	Ra 80	SMD
[IP] 44	[°C] 5+30	[m] 0,1m	[°] X120/Y105	[m] 1,5	[m] 65	[m] 80	[m] 80
[EAC]	[UK CA]	[CE]	[EAC]	[UK CA]	[CE]	[EAC]	[UK CA]

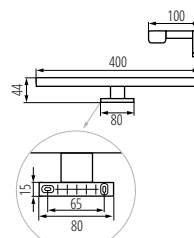

ASTIM IP44 8W

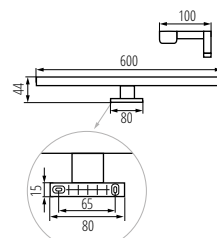

ASTIM IP44 12W

Kanlux

ROLSO

LUMINAIRE MURAL LED IP44 ▶ LAMPADA DA PARETE LED IP44



ROLSO LED IP44 15W-NW



ROLSO LED IP44 15W-NW	26700	5905339267009	15	blanc / chrome bianco / cromo	1470	4000
-----------------------	--------------	---------------	----	---------------------------------	------	------

[V] 220-240 AC	[Hz] 50	[mm] ≥15000	[h] 25000	[h] 25000	[lm] ≤6xMacadam	Ra 80	SMD
[IP] 44	[°C] 5+30	[m] 0,75+1,5	[m] 0,1m	[m] 1,5	[m] 65	[m] 98	[m] 65
[EAC]	[UK CA]	[CE]	[EAC]	[UK CA]	[CE]	[EAC]	[UK CA]

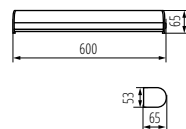

ROLSO LED IP44 15W-NW



Kanlux ASTIM est une réglette de salle de bains à étanchéité renforcée (IP44). Ces luminaires peuvent être montés sur un cadre ou une armoire. Avec trois couleurs vous pouvez les assortir à salles de bains au décor traditionnel ou moderne.

Matériau du boîtier: alliage en aluminium

Matériau du diffuseur: matériau plastique

Kanlux ASTIM è una lampada per il bagno a tenuta stagna (IP44). Può essere montata sopra uno specchio o un armadietto del bagno. I tre colori garantiscono flessibilità di impiego.

Materiale del corpo: alluminio

Diffusore: plastica



Kanlux ROLS LED est une réglette LED avec un design subtile, qui sied aux espaces modernes. Ce luminaire sera parfait comme éclairage de salle de bain, grâce à son indice de protection IP44.

Matériau du boîtier: alliage en aluminium

Matériau du diffuseur: matériau plastique

Kanlux ROLS LED è un moderno apparecchio domestico a LED che emette luce di alta qualità, è sottile ed ha un design che si sposa bene con ambienti moderni. Questo apparecchio è adatto all'illuminazione del bagno, grazie all'elevato IP (44) e può essere utilizzato in tutti gli ambienti umidi.

Materiale del corpo: alluminio

Diffusore: plastica

ASTEN LED IP44

LUMINAIRE MURAL LED ▶ LAMPADA DA PARETE LED



ASTEN LED IP44 8W-NW



Kanlux ASTEN LED est un luminaire mural de ligne qui sera parfait dans des pièces à humidité élevée (IP44). Nous pouvons l'installer sans crainte au-dessus du miroir de la salle de bain. La lampe possède des sources lumineuses intégrées à base de diodes LED SMD dont la durée de vie est d'au moins 25000 heures.

Matériau du boîtier: alliage en aluminium
Matériau du diffuseur: matériau plastique

Kanlux ASTEN LED è una lampada da parete lineare che può essere utilizzata in ambienti con umidità elevata (IP44). Può essere montata sopra lo specchio in bagno. La lampada è dotata di un modulo LED SMD integrato, che garantisce una durata di almeno 25000 ore.

Materiale del corpo: alluminio
Diffusore: plastica



ASTEN LED IP44 8W-NW	26680	5905339266804	8	chrome cromo	660	4000
ASTEN LED IP44 12W-NW	26681	5905339266811	12	chrome cromo	1010	4000
ASTEN LED IP44 15W-NW	26682	5905339266828	15	chrome cromo	1340	4000
ASTEN IP44 8W-NW-B	26683	5905339266835	8	noir nero	590	4000
ASTEN IP44 12W-NW-B	26684	5905339266842	12	noir nero	910	4000
ASTEN IP44 15W-NW-B	26685	5905339266859	15	noir nero	1230	4000
ASTEN IP44 8W-NW-W	26686	5905339266866	8	blanc bianco	690	4000
ASTEN IP44 12W-NW-W	26687	5905339266873	12	blanc bianco	1070	4000
ASTEN IP44 15W-NW-W	26688	5905339266880	15	blanc bianco	1450	4000

[V] 220-240 AC	[Hz] 50	[°] X120/Y105	[h] ≥15000	[h] 25000	[Ra] Ra 80	[SMD]
[IP] IP 44	[°C] 5+30	[mm] 0,75÷1,5	[CE]	[EAC]	[UKCA]	[RoHS]
[Light]	[Beam]	[Hg]	[CE]	[EAC]	[UKCA]	[RoHS]

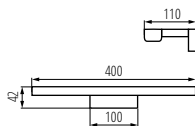

ASTEN LED IP44 8W

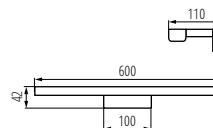

ASTEN LED IP44 12W

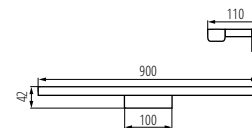

ASTEN LED IP44 15W

Kanlux

ASTEN LED IP44

LUMINAIRE MURAL LED ► LAMPADA DA PARETE LED



ASTEN LED IP44 8W-NW



ASTEN LED IP44 12W-NW



ASTEN LED IP44 15W-NW



ASTEN IP44 8W-NW-B



ASTEN IP44 12W-NW-B



ASTEN IP44 15W-NW-B



ASTEN IP44 8W-NW-W



ASTEN IP44 12W-NW-W



ASTEN IP44 15W-NW-W



Kanlux

AKVO IP44 S

LUMINAIRE MURAL LED ▶ LAMPADA DA PARETE LED

NEW



AKVO IP44 23W

AKVO IP44 20W

AKVO IP44 15W



AKVO IP44 15W-NW-W S



AKVO IP44 15W-NW-B S



AKVO IP44 15W-NW-C S



Kanlux AKVO IP44 S est une réglette LED avec un design subtile, qui sied aux espaces modernes. Il existe en trois couleurs: blanc, chrome et noire et en trois puissances: 60 cm - 15W, 80 cm - 20 W et 100 cm - 23 W. Ce luminaire sera parfait comme éclairage de salle de bain, grâce à son indice de protection IP44. Cette réglette se distingue par efficacité lumineuse élevée, atteignant 100 lm / W.

Matériau du boîtier: alliage en aluminium

Matériau du diffuseur: matériau plastique

Kanlux AKVO IP44 S sono lampade da parete e soffitto disponibili in tre colori: bianco, cromo e nero. L'apparecchio è disponibile in 3 lunghezze e tre potenze: 60cm - 15W, 80cm - 20W, e 100cm - 23W. Le lampade Kanlux AKVO S possono essere montate verticalmente e orizzontalmente, sulla parete o sul soffitto. Inoltre, queste lampade hanno un grado IP44 e sono quindi adatte a ambienti umidi quali bagni o lavanderie. Kanlux AKVO S. Le Kanlux AKVO S sono dotate di un interruttore integrato nel corpo della lampada. Queste lampade hanno un'elevata efficienza luminosa, oltre 100 lumen per Watt garantendo un buon risparmio energetico.

Materiale del corpo: alluminio

Diffusore: plastica



	[W]	[Hz]	[h]	[lm]	[Ra]	[Tc IK1]
AKVO IP44 15W-NW-W S	36650	5905339366504	15	blanc bianco	1600	4000
AKVO IP44 15W-NW-B S	36651	5905339366511	15	noir nero	1600	4000
AKVO IP44 15W-NW-C S	36652	5905339366528	15	chrome cromo	1600	4000
AKVO IP44 20W-NW-W S	36653	5905339366535	20	blanc bianco	2300	4000
AKVO IP44 20W-NW-B S	36654	5905339366542	20	noir nero	2300	4000
AKVO IP44 20W-NW-C S	36655	5905339366559	20	chrome cromo	2300	4000
AKVO IP44 23W-NW-W S	36656	5905339366566	23	blanc bianco	2750	4000
AKVO IP44 23W-NW-B S	36657	5905339366573	23	noir nero	2750	4000
AKVO IP44 23W-NW-C S	36658	5905339366580	23	chrome cromo	2750	4000

[V]	[Hz]	[h]	[Ra]	[SMD]	[mm]	[m]
220-240 AC	50	15000 25000	80	SMD	0,75-1,5	0,1m
IP 44	5+30					
CE	EAC	UK CA				

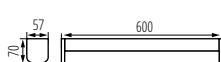

AKVO IP44 15W

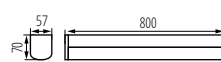

AKVO IP44 20W

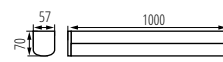

AKVO IP44 23W

Kanlux

AKVO IP44

LUMINAIRE POUR MURS ET PLAFONDS LED ► FARETTO LED DA PARETE/SOFFITTO

NEW

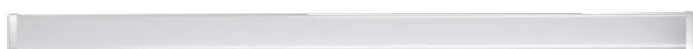

AKVO IP44 23W



AKVO IP44 20W

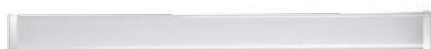

AKVO IP44 15W



AKVO IP44 15W-NW-W



AKVO IP44 15W-NW-B



AKVO IP44 15W-NW-C



Kanlux AKVO IP44 est une réglette LED avec un design subtile, qui sied aux espaces modernes. Il existe en trois couleurs: blanc, chrome et noire et en trois puissances: 60 cm - 15W, 80 cm - 20 W et 100 cm - 23 W. Ce luminaire sera parfait comme éclairage de salle de bain, grâce à son indice de protection IP44. Cette réglette se distingue par efficacité lumineuse élevés, atteignant 100 lm / W.

Matériau du boîtier: alliage en aluminium

Matériau du diffuseur: matériau plastique

Kanlux AKVO IP44 sono lampade da parete e soffitto disponibili in tre colori: bianco, cromo e nero. AKVO ha 3 lunghezze e tre potenze: 60cm - 15W, 80cm - 20W, e 100cm - 23W. Le lampade Kanlux AKVO possono essere montate verticalmente e orizzontalmente, sulla parete o sul soffitto. Inoltre, queste lampade hanno un grado IP44 e sono quindi adatte a ambienti umidi quali bagni o lavanderie. Kanlux AKVO Le Kanlux AKVO sono dotate di un interruttore integrato nel corpo della lampada. Queste lampade hanno un'elevata efficienza luminosa, oltre 100 lumen per Watt garantendo un buon risparmio energetico.

Materiale del corpo: alluminio

Diffusore: plastica

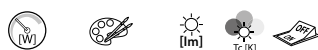

AKVO IP44 15W-NW-W	36659	5905339366597	15	blanc bianco	1600	4000
AKVO IP44 15W-NW-B	36660	5905339366603	15	noir nero	1600	4000
AKVO IP44 15W-NW-C	36661	5905339366610	15	chrome cromo	1600	4000
AKVO IP44 20W-NW-W	36662	5905339366627	20	blanc bianco	2300	4000
AKVO IP44 20W-NW-B	36663	5905339366634	20	noir nero	2300	4000
AKVO IP44 20W-NW-C	36664	5905339366641	20	chrome cromo	2300	4000
AKVO IP44 23W-NW-W	36665	5905339366658	23	blanc bianco	2750	4000
AKVO IP44 23W-NW-B	36666	5905339366665	23	noir nero	2750	4000
AKVO IP44 23W-NW-C	36667	5905339366672	23	chrome cromo	2750	4000

[V]	[Hz]	☞	(h)	Ra	SMD	⊗
220-240 AC	50	15000	25000	80		
☐	IP 44	☼	☼	☼	☼	☼
		5+30		0,75-1,5	0,1m	
CE	EAC	UK CA	♻️			

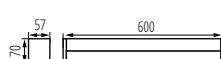

AKVO IP44 15W

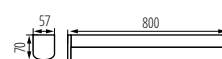

AKVO IP44 20W

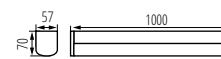

AKVO IP44 23W

ERINUS LED

LUMINAIRE LED POUR MARCHES ESCALIER ▶ SEGNAPASSI



ERINUS LED L W



ERINUS LED L W-WW	33320	5905339333209	12 DC	0,8	blanc bianco	15	3000
ERINUS LED L W-NW	33321	5905339333216	12 DC	0,8	blanc bianco	15	4000
ERINUS LED O W-WW	33322	5905339333223	12 DC	0,8	blanc bianco	15	3000
ERINUS LED O W-NW	33323	5905339333230	12 DC	0,8	blanc bianco	15	4000
ERINUS LED LL W-WW	33324	5905339333247	12 DC	1,5	blanc bianco	30	3000
ERINUS LED LL W-NW	33325	5905339333254	12 DC	1,5	blanc bianco	30	4000
ERINUS LED L GR-NW	33327	5905339333278	12 DC	0,8	gris grigio	15	4000
ERINUS LED LL GR-WW	33330	5905339333308	12 DC	1,5	gris grigio	30	3000
ERINUS LED LL GR-NW	33331	5905339333315	12 DC	1,5	gris grigio	30	4000
ERINUS LED L B-WW	33332	5905339333322	12 DC	0,8	noir nero	15	3000
ERINUS LED L B-NW	33333	5905339333339	12 DC	0,8	noir nero	15	4000
ERINUS LED O B-WW	33334	5905339333346	12 DC	0,8	noir nero	15	3000
ERINUS LED O B-NW	33335	5905339333353	12 DC	0,8	noir nero	15	4000
ERINUS LED LL B-WW	33336	5905339333360	12 DC	1,5	noir nero	30	3000
ERINUS LED LL B-NW	33337	5905339333377	12 DC	1,5	noir nero	30	4000

≥15000	30000	ellipse ≤ 60 MacAdam	Ra 80	III	IP 20	House icon	Arrow icon
0,1m	SMD	5+25	CE	EAC	UK CA	Recycle icon	

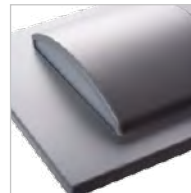

Kanlux ERINUS est une gamme unique de luminaires pour marches d'escalier, avec un matériau plastique de qualité supérieure. Ces luminaires se caractérisent par une légèreté exceptionnelle due aux à leur matériaux et en même temps avec une exécution fine pour chaque détail. Kanlux ERINUS sont très fins, donc ils s'insèrent dans les murs avec un affleurement discret. Il est proposé en trois couleurs (blanc, noir et gris), deux teinte de lumières (lumière chaude et neutre) et trois modèles différents de luminaires. Le Kanlux ERINUS L est un luminaire carré, éclairant dans un seule direction, le modèle LL éclaire dans les deux directions, et le Kanlux ERINUS O est un luminaire rond qui brille éclaire dans un seul sens.

Matériau du boîtier: matériau plastique

Matériau du diffuseur: matériau plastique

Kanlux ERINUS è una serie unica di segnapassi premium in plastica. Questi apparecchi sono estremamente leggeri grazie ai materiali con cui sono stati realizzati, e allo stesso tempo si tratta di prodotti rifiniti accuratamente e nei quali emerge l'attenzione per i dettagli. I Kanlux ERINUS sono molto sottili. Disponibili in tre colori: bianco, nero e grigio, due tonalità di luce (caldo e neutro) oltre a tre diversi forme. Kanlux ERINUS L di forma quadrata (unidirezionale), il modello LL (bidirezionale) e il modello Kanlux ERINUS O è un segnapasso rotondo.

Materiale del corpo: plastica

Diffusore: plastica

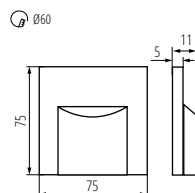

ERINUS LED L

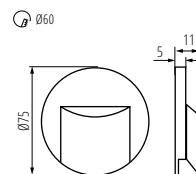

ERINUS LED O

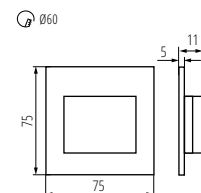

ERINUS LED LL

Kanlux

ERINUS LED

LUMINAIRE LED POUR MARCHES ESCALIER ► SEGNAPASSI

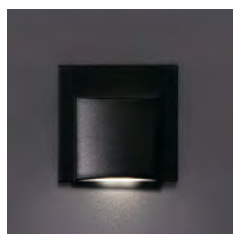

ERINUS LED L B



ERINUS LED L W



ERINUS LED L GR

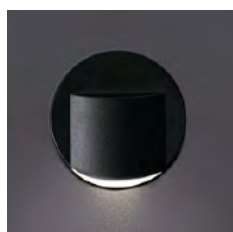

ERINUS LED O B



ERINUS LED O W

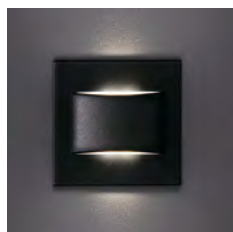

ERINUS LED LL B



ERINUS LED LL W



ERINUS LED LL GR



APUS LED

LUMINAIRE LED POUR MARCHES ESCALIER ▶ SEGNAPASSI



APUS LED AC



APUS LED PIR B



APUS LED B



APUS LED W

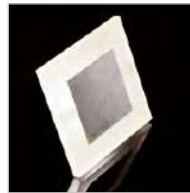

Kanlux APUS offre un design moderne lié à un effet d'éclairage attrayant. C'est une excellente solution pour éclairer les escaliers et les couloirs, ainsi que pour accentuer l'aménagement des pièces. La structure insolite du luminaire assure une répartition uniforme de la lumière. La version AV est dotée d'un bloc d'alimentation qui entre dans le boîtier, tandis que la version PIR possède un capteur de mouvement. Le capteur détecte le mouvement/déclenche l'allumage de la lumière indépendamment de l'intensité de la lumière dans l'entourage.

Matériau du boîtier: acier inoxydable poli, matériau plastique

Kanlux APUS è il design moderno unito ad un attraente effetto luce. È un'idea eccellente per illuminare scale e corridoi oppure per accentuare il design interno di una stanza. Il design unico dell'apparecchio garantisce un'emissione luminosa uniforme. La versione AC è dotata di un alimentatore 230V racchiuso in una scatola, invece la versione PIR ha un sensore di movimento. Il sensore rileva un movimento / accende la luce indipendentemente dall'intensità della luce dell'ambiente circostante.

Materiale del corpo: acciaio inox lucidato, plastica



APUS LED WW	23106	5905339231062	12 DC	0,8	acier inoxydable acciaio inox	13	3000
APUS LED CW	23107	5905339231079	12 DC	0,8	acier inoxydable acciaio inox	15	6500
APUS LED AC-WW	23800	5905339238009	220-240 AC	1,3	acier inoxydable acciaio inox	13	3000
APUS LED AC-CW	23801	5905339238016	220-240 AC	1,3	acier inoxydable acciaio inox	15	6500
APUS LED AC B-NW	26536	5905339265364	220-240 AC	1,3	noir nero	14	4000
APUS LED AC B-WW	26537	5905339265371	220-240 AC	1,3	noir nero	13	3000
APUS LED B-NW	26538	5905339265388	12 DC	0,8	noir nero	14	4000
APUS LED B-WW	26539	5905339265395	12 DC	0,8	noir nero	13	3000
APUS LED W-WW	26840	5905339268402	12 DC	0,8	blanc bianco	13	3000
APUS LED W-CW	26841	5905339268419	12 DC	0,8	blanc bianco	15	6500
APUS LED P68 B-NW CZ	27084	5905339270849	12 DC	0,8	noir nero	14	4000
APUS LED PIR WW	27370	5905339273703	12 DC	0,8	acier inoxydable acciaio inox	13	3000
APUS LED W-NW	27378	5905339273789	12 DC	0,8	blanc bianco	14	4000
APUS LED PIR NW	27379	5905339273796	12 DC	0,8	acier inoxydable acciaio inox	14	4000
APUS LED PIR B-NW	29856	5905339298560	12 DC	0,8	noir nero	14	4000
APUS LED PIR B-WW	29857	5905339298577	12 DC	0,8	noir nero	13	3000
APUS LED NW	32488	5905339324887	12 DC	0,8	acier inoxydable acciaio inox	14	4000

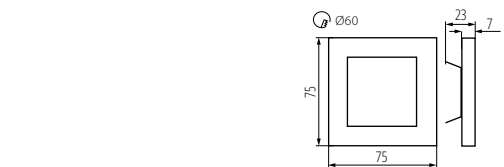

APUS LED

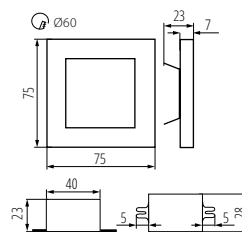

APUS LED AC

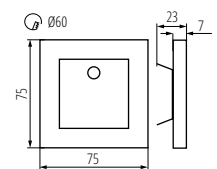

APUS LED PIR

≥20000	50000	ellipse ≤ 60 MacAdam	Ra 80	IP 20	0,18
0,1m	SMD	5+25	CE	EAC	UK CA

TERRA LED

LUMINAIRE LED POUR MARCHES ESCALIER ► SEGNAPASSI



TERRA LED B; TERRA LED AC B



TERRA LED PIR B



TERRA LED W



Kanlux TERRA offre un design moderne lié à un effet d'éclairage attrayant. C'est une excellente solution pour éclairer les escaliers et les couloirs, ainsi que pour accentuer l'aménagement des pièces. La structure insolite du luminaire assure une répartition uniforme de la lumière. La version AV est dotée d'un bloc d'alimentation qui entre dans le boîtier, tandis que la version PIR possède un capteur de mouvement. Le capteur détecte le mouvement/déclenche l'allumage de la lumière indépendamment de l'intensité de la lumière dans l'entourage.

Matériau du boîtier: acier inoxydable poli, matériau plastique

Kanlux TERRA è una famiglia di segnapassi dal design moderno unito ad un attraente effetto luminoso. Il design unico dell'apparecchio garantisce un'emissione luminosa uniforme. La versione AC è dotata di un alimentatore 230V racchiuso in una scatola, invece la versione PIR ha un sensore di movimento. Il sensore rileva un movimento / accende la luce indipendentemente dall'intensità della luce dell'ambiente circostante.

Materiale del corpo: acciaio inox lucidato, plastica



TERRA LED WW	23102	5905339231024	12 DC	0,8	acier inoxydable	acciaio inox	13	3000
TERRA LED CW	23104	5905339231048	12 DC	0,8	acier inoxydable	acciaio inox	15	6500
TERRA LED AC-WW	23806	5905339238061	220-240 AC	1,3	acier inoxydable	acciaio inox	13	3000
TERRA LED W-WW	26842	5905339268426	12 DC	0,8	blanc bianco		13	3000
TERRA LED W-CW	26843	5905339268433	12 DC	0,8	blanc bianco		15	6500
TERRA LED B-NW	26848	5905339268488	12 DC	0,8	noir nero		14	4000
TERRA LED B-WW	26849	5905339268495	12 DC	0,8	noir nero		13	3000
TERRA LED P68 CW CZ	27082	5905339270825	12 DC	0,8	acier inoxydable	acciaio inox	15	6500
TERRA LED P68 WW CZ	27083	5905339270832	12 DC	0,8	acier inoxydable	acciaio inox	13	3000
TERRA LED P68 B-NW CZ	27088	5905339270887	12 DC	0,8	noir nero		14	4000
TERRA LED P68 B-WW CZ	27089	5905339270894	12 DC	0,8	noir nero		13	3000
TERRA LED PIR B-NW	29860	5905339298607	12 DC	0,8	noir nero		14	4000
TERRA LED PIR B-WW	29861	5905339298614	12 DC	0,8	noir nero		13	3000

≥20000	50000	ellipse ≤ für Nockdam	Ra 80	IP 20			0,18
	SMD	5+25					

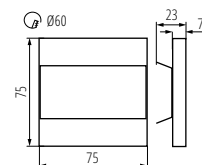

TERRA LED

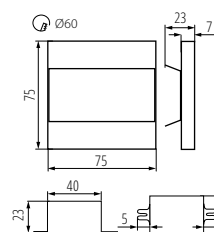

TERRA LED AC

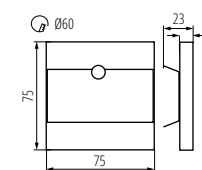

TERRA LED PIR B

SABIK LED

LUMINAIRE LED POUR MARCHES ESCALIER ▶ SEGNAPASSI



SABIK LED; SABIK LED AC



SABIK LED PIR



SABIK MINI LED B



SABIK LED B



SABIK LED WW	23108	5905339231086	12 DC	0,8	acier inoxydable acciaio inox	13	3000
SABIK MINI LED WW	23109	5905339231093	12 DC	0,8	acier inoxydable acciaio inox	13	3000
SABIK LED CW	23110	5905339231109	12 DC	0,8	acier inoxydable acciaio inox	15	6500
SABIK MINI LED CW	23111	5905339231116	12 DC	0,8	acier inoxydable acciaio inox	15	6500
SABIK LED AC-WW	23802	5905339238023	220-240 AC	1,3	acier inoxydable acciaio inox	13	3000
SABIK LED PIR WW	27374	5905339273741	12 DC	0,8	acier inoxydable acciaio inox	13	3000
SABIK LED B-NW	29852	5905339298522	12 DC	0,8	noir nero	14	4000
SABIK LED B-WW	29853	5905339298539	12 DC	0,8	noir nero	13	3000
SABIK MINI LED B-NW	29854	5905339298546	12 DC	0,8	noir nero	14	4000
SABIK MINI LED B-WW	29855	5905339298553	12 DC	0,8	noir nero	13	3000
SABIK LED PIR B-NW	29858	5905339298584	12 DC	0,8	noir nero	14	4000
SABIK LED PIR B-WW	29859	5905339298591	12 DC	0,8	noir nero	13	3000
SABIK MINI LED NW	32490	5905339324900	12 DC	0,8	acier inoxydable acciaio inox	14	4000

≥20000	50000	s (in Macadam)	Ra 80	IP 20	0,18
0,1m	SMD	5+25	CE	ENEC	UKCA

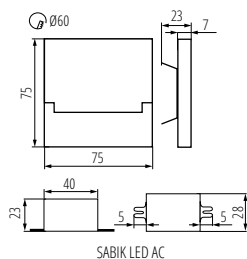

SABIK LED AC

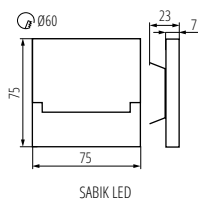

SABIK LED

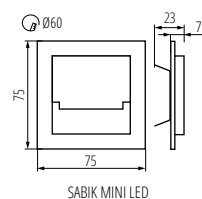

SABIK MINI LED

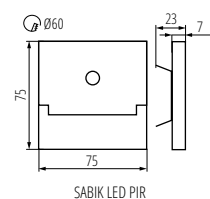

SABIK LED PIR

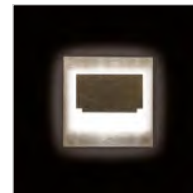
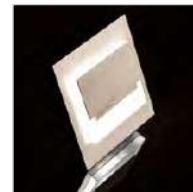

Kanlux SABIK offre un design moderne lié à un effet d'éclairage attrayant. C'est une excellente solution pour éclairer les escaliers et les couloirs, ainsi que pour accentuer l'aménagement des pièces. La structure insolite du luminaire assure une répartition uniforme de la lumière. La version AV est dotée d'un bloc d'alimentation qui entre dans le boîtier, tandis que la version PIR possède un capteur de mouvement. Le capteur détecte le mouvement/déclenche l'allumage de la lumière indépendamment de l'intensité de la lumière dans l'entourage.

Matériau du boîtier: acier inoxydable poli, matériau plastique

Kanlux SABIK è il design moderno unito ad un attraente effetto luce. È un'idea eccellente per illuminare scale e corridoi oppure per accentuare il design interno di una stanza. Il design unico dell'apparecchio garantisce un'emissione luminosa uniforme. La versione AC è dotata di un alimentatore 230V racchiuso in una scatola, invece la versione PIR ha un sensore di movimento. Il sensore rileva un movimento / accende la luce indipendentemente dall'intensità della luce dell'ambiente circostante.

Materiale del corpo: acciaio inox lucidato, plastica

SOLA LED

LUMINAIRE LED POUR MARCHES ESCALIER ► SEGNAPASSI



SOLA LED



SOLA LED B; SOLA LED AC B

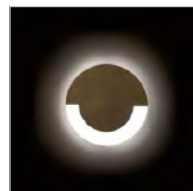

Kanlux SOLA offre un design moderne lié à un effet d'éclairage attrayant. C'est une excellente solution pour éclairer les escaliers et les couloirs, ainsi que pour accentuer l'aménagement des pièces. La structure insolite du luminaire assure une répartition uniforme de la lumière. La version AV est dotée d'un bloc d'alimentation qui entre dans le boîtier.

Matériau du boîtier: acier inoxydable poli, matériau plastique

Kanlux SOLA è il design moderno unito ad un attraente effetto luce. È un'idea eccellente per illuminare scale e corridoi oppure per accentuare il design interno di una stanza. Il design unico dell'apparecchio garantisce un'emissione luminosa uniforme. La versione AC è dotata di un alimentatore 230V racchiuso in una scatola.

Materiale del corpo: acciaio inox lucidato, plastica



SOLA LED VW	23100	5905339231000	12 DC	0,8	acier inoxydable acciaio inox	13	3000
SOLA LED AC-VW	23804	5905339238047	220-240 AC	1,3	acier inoxydable acciaio inox	13	3000
SOLA LED B-NW	27558	5905339275585	12 DC	0,8	noir nero	14	4000
SOLA LED B-VW	27559	5905339275592	12 DC	0,8	noir nero	13	3000
SOLA LED NW	32491	5905339324917	12 DC	0,8	acier inoxydable acciaio inox	14	4000

≥20000	50000	≤ 60 Macadam	80	IP 20	0,1m	0,18
0,1m	SMD	5+25	CE	EAC	UK	

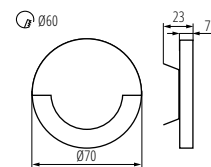

SOLA LED

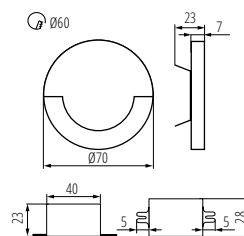

SOLA LED AC

Kanlux

IRS 3XAAA

LUMINAIRE LED POUR MARCHES ESCALIER ► SEGNAPASSI

NEW



IRS3xAAA LED PIR W-NW



KANLUX IRS c'est un luminaire escalier alimenté par batterie AAA. Trois modes de fonctionnement: ON/OFF/AUTO. Montage facile avec un adhésif 3M ou deux vises.

Matériau du boîtier: matériau plastique

Matériau du diffuseur: matériau plastique

Kanlux IRS è un segnapassi a batteria (AAA) ideale per le scale. Ha tre modalità di accensione ed è dotato di un sensore crepuscolare e di movimento. È inoltre possibile montare la lampada Kanlux IRS utilizzando nastri o due viti di montaggio (incluse t). La comodità maggiore è il funzionamento a batteria che garantisce ampie possibilità di collocazione della stessa.

Materiale del corpo: plastica

Diffusore: plastica



IRS3xAAA LED PIR W-NW | 37392 | 5905339373922 | 3 x 1,5 DC | 0,3 | blanc | bianco | 10 | 4000

25000	Ra 80		IP 54			0,1m	0+25
33	max 5	PIR					

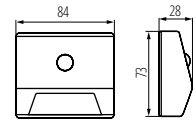

IRS3xAAA LED PIR W-NW

Kanlux

MEFIS LED

LUMINAIRE LED POUR MARCHES ESCALIER ► SEGNAPASSI



MEFIS LED W-NW



MEFIS LED B-NW



Kanlux MEFIS LED est une série atypique de luminaires décoratifs. Ce luminaire est disponible en blanc, noir et gris, ce qui vous permet de choisir la bonne couleur pour votre intérieur. Le luminaire à LED Kanlux MEFIS a une forme unique et un flux lumineux concentré qui peut être dirigé pour éclairer les endroits souhaités.

Matériau du boîtier: matériau plastique

Kanlux MEFIS LED è una serie di segnapassi progettata per le scale. Questo apparecchio è disponibile in tre colori: bianco, nero e grigio. L'apparecchio Kanlux MEFIS LED è caratterizzato da una forma particolare e da un flusso luminoso focalizzato.

Materiale del corpo: plastica



MEFIS LED W-NW | 32495 | 5905339324955 | 12 DC | 0,7 | blanc | bianco | 35 | 4000
MEFIS LED B-NW | 32497 | 5905339324979 | 12 DC | 0,7 | noir | nero | 35 | 4000

≥20000	50000	Ra 80	IP 20			0,18	5+25

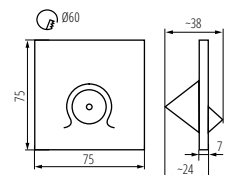

MEFIS LED

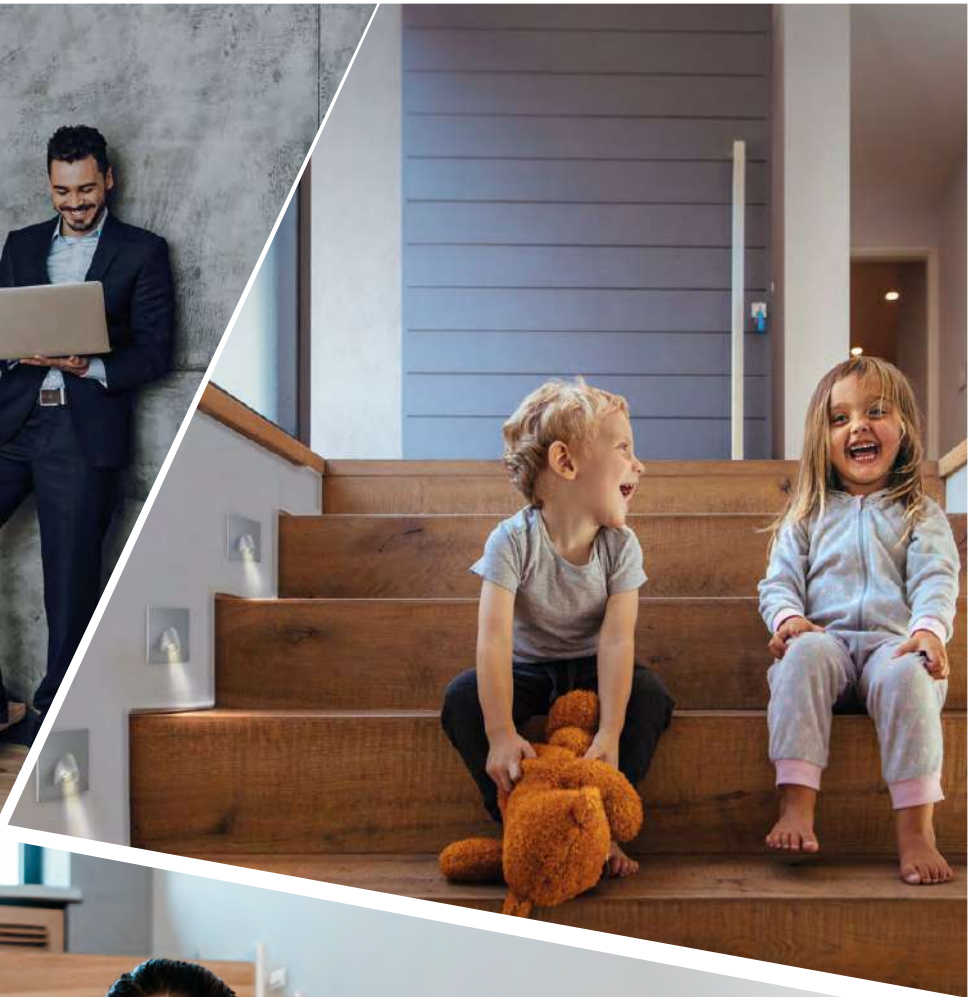
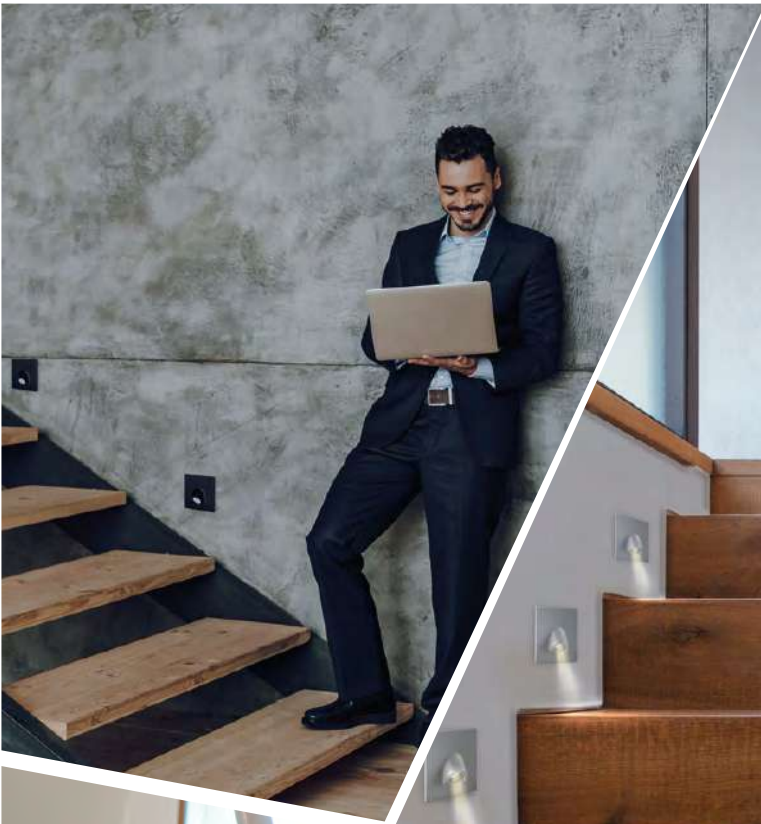

Kanlux ZEPO

LUMINAIRE POUR MEUBLE ▶ LAMPADA SOTTOPENSILE SPOT



ZEPO LFD-T02/S-W



ZEPO LFD-T02/S-B



ZEPO LFD-T02/S-W



ZEPO LFD-T02-C/M



ZEPO LFD-T02-B



ZEPO LFD-T02-W

Les luminaires Kanlux ZEPO sont conçus pour être montés sous les armoires, par exemple au-dessus d'un plan de travail de cuisine. Ils sont disponibles dans les couleurs les plus courantes: noir, blanc et argent (chrome), ce qui leur permet de s'intégrer dans presque tous les types d'intérieurs. Les lampes Kanlux ZEPO sont disponibles avec ou sans interrupteur (la version avec interrupteur porte un „S” dans son nom). Les sources lumineuses remplaçables avec un culot G4 conviennent à ces lampes.

Luminaire ZEPO LFD-T02/S-C/M équipé d'un interrupteur d'alimentation

Matériau du boîtier: acier

Matériau du diffuseur: verre

Kanlux ZEPO sono delle lampade sottopensili ideali per la cucina. Gli ZEPO sono disponibili sia con interruttore che senza. Gli spot si abbinano con lampadine con attacco G4.

Materiale del corpo: metallo

Diffusore: vetro



ZEPO LFD-T02-C/M	04381	5905339043818	max 10	chrome mat cromato opaco	
ZEPO LFD-T02/S-C/M	04386	5905339043863	max 10	chrome mat cromato opaco	✓
ZEPO LFD-T02-B	36630	5905339366306	max 10	noir nero	
ZEPO LFD-T02-W	36631	5905339366313	max 10	blanc bianco	
ZEPO LFD-T02/S-B	36632	5905339366320	max 10	noir nero	✓
ZEPO LFD-T02/S-W	36633	5905339366337	max 10	blanc bianco	✓

12 AC; 12 DC		IP 20			
0,5m	0,1	5+25			

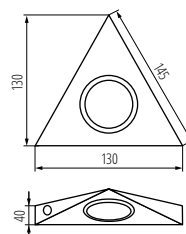

ZEPO LFD-T02/S

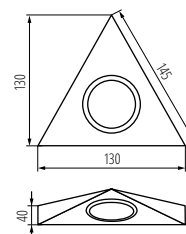

ZEPO LFD-T02

Kanlux

MERA LED

LUMINAIRE LED POUR MEUBLE ► SOTTOPENSILE LED



MERA LED 5W NW



MERA LED 10W NW



MERA LED 15W NW



MERA LED 20W NW

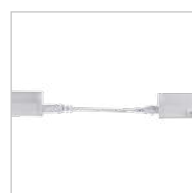

Kanlux MERA LED est un luminaire à installer sous les meubles de support avec une source lumineuse à LED intégrée. Les luminaires sont disponibles dans les dimensions allant de 28 à 114 cm. Il est également possible de les relier (jusqu'à 5 luminaires) à l'aide des connecteurs Kanlux MERA LED PP.

Matériau du boîtier: matériau plastique
Matériau du diffuseur: matériau plastique

Kanlux MERA LED è la lampada sottopensile con un modulo led integrato. Le lampade sono disponibili nelle dimensioni da 28 a 114 cm, inoltre, è possibile collegarle in fila continua (fino a 5 lampade) tramite i connettori Kanlux MERA LED PP.

Materiale del corpo: plastica
Diffusore: plastica



MERA LED 5W NW	29210	5905339292100	5	blanc bianco	490	4000
MERA LED 10W NW	29211	5905339292117	10	blanc bianco	1040	4000
MERA LED 15W NW	29212	5905339292124	15	blanc bianco	1600	4000
MERA LED 20W NW	29213	5905339292131	20	blanc bianco	2030	4000

[V] 220-240 AC	[Hz] 50	[°] 150	[h] ≥15000	[h] 30000	[lm] ≤60 Mac/Modem	Ra 80	SMD	IP 20
			0,3m	1,5	5+25			

ACCESSOIRES ► ACCESSORI

MERA LED PP | **29214** | 5905339292148 Câble pour connecter les luminaires MERA LED PP | Cavo di collegamento apparecchio MERA LED PP



MERA LED 5W NW



MERA LED 10W NW

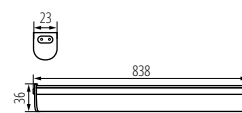

MERA LED 15W NW

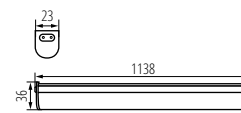

MERA LED 20W NW

Kanlux LINUS LED

LUMINAIRE LED POUR MEUBLE ► SOTTOPENSILE LED



Le luminaire pour meubles Kanlux LINUS LED se caractérise par un design classique et universel. Grâce à ses dimensions compactes, cette lampe s'adapte parfaitement à l'éclairage de différents types de meubles, placards et étagères. Kanlux LINUS LED peut être assemblé par dérivation au moyen du câble LINUS LINK.

Matériau du boîtier: matériau plastique

Matériau du diffuseur: matériau plastique

La Impada sottopensile Kanlux LINUS LED è caratterizzata dal design classico e universale. Grazie alle sue dimensioni compatte la lampada è ideale per illuminare diversi tipi di mobili, mobilette e mensole. Kanlux LINUS LED può essere montata in maniera passante tramite il cavo LINUS LINK.

Materiale del corpo: plastica

Diffusore: plastica



LINUS LED 4W-NW



LINUS LED 7W-NW



LINUS LED 4W-NW	27590	5905339275905	4	blanc bianco	390	4000
LINUS LED 7W-NW	27591	5905339275912	7	blanc bianco	760	4000

[V]	[Hz]	[h]	[lm]	Ra	SMD	IP
220-240 AC	50	≥15000	30000	80		20
[m]	[m]	[m]	[m]	[°C]	CE	UK CA
1,5	0,1m	5+25				

AKCESORIA ► ACCESSORI

LINUS LINK | **14977** | 5907540960618 | Przewód do łączenia opraw LINUS LINK | Cavo di collegamento apparecchio LINUS LINK

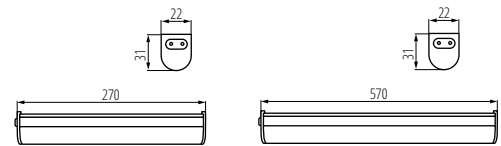

LINUS LED 4W

LINUS LED 7W

Kanlux HAXA LED

MODULE D'ÉCLAIRAGE D'ACCENTUATION À LED ► FARETTO INCASSO LED



HAXA-DSO



Le spot pour murs et plafonds Kanlux HAXA LED est un petit point lumineux parfait comme éclairage supplémentaire.

Pour le bon fonctionnement, est nécessaire un adaptateur d'alimentation de 350 mA DC, par exemple, ADI 350 ou RICO disponible dans l'offre de Kanlux

Matériau du boîtier: alliage en aluminium

Matériau du diffuseur: matériau plastique

Kanlux HAXA LED è un piccolo spot led da incasso realizzato in alluminio.

Materiale del corpo: alluminio

Diffusore: plastica

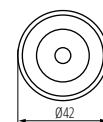
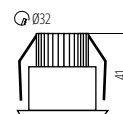

HAXA-DSO

HAXA-DSO POWER LED-B	08103	5905339081032	1,2	aluminium alluminio	110	20	3000	F
----------------------	--------------	---------------	-----	-----------------------	-----	----	------	---

In [mA]	[h]	Ra	IP	[m]	[m]	[°C]
350	≥20000	40000	80	20	0,1	5+25
[m]	[mm]	[m]	[°]	CE	UK CA	
0,1	Ø32	0,1m	90°			

Kanlux GAVI LED

LUMINAIRE LED D'ÉCLAIRAGE D'ACCENTUATION POUR MEUBLE ► FARETTO SPOT LED



GAVI LED18 SMD-WW-C/M



GAVI LED18 SMD-WW-C/M | **19761** | 5905339197610 | 0,8 | chrome mat | cromato opaco | 42 | 3000

[V] 12 DC		≥15000	30000	[h] + ellipse ≤ (x) Macadam	Ra 80	SMD			
5+25		0,1m	Ø60	[mm] 0,14	[m] 53	lm W	CE	ERC	UK CA

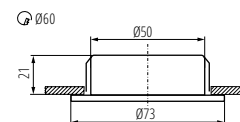

GAVI LED18 SMD-WW-C/M

Kanlux GAVI

LUMINAIRE LED POUR MEUBLE ► FARETTO SPOT



GAVI CT-2116B-W



GAVI CT-2116B-W	00810	5905339008107	max 10	blanc bianco
GAVI CT-2116B-C	00811	5905339008114	max 10	chrome cromo
GAVI CT-2116B-C/M	00815	5905339008152	max 10	chrome mat cromato opaco

[V] 12 AC; 12 DC	G4			IP 20		5+25	
0,5m	Ø60		CE	ERC	UK CA		



GAVI CT-2116B-C



GAVI CT-2116B-C/M



Kanlux GAVI sont des spots encastrables pour meubles, fabriqués en verre et en acier. Leurs couleurs sans prétention leur permettent de s'intégrer de manière discrète dans l'espace d'installation.

Matériau du boîtier: acier

Kanlux GAVI sono faretto incasso per mobili realizzati in vetro e acciaio. I colori non pretenziosi permettono loro di inserirsi discretamente in qualsiasi ambiente. Attacco G4.

Materiale del corpo: metallo

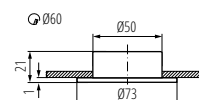

GAVI CT-2116B

Kanlux

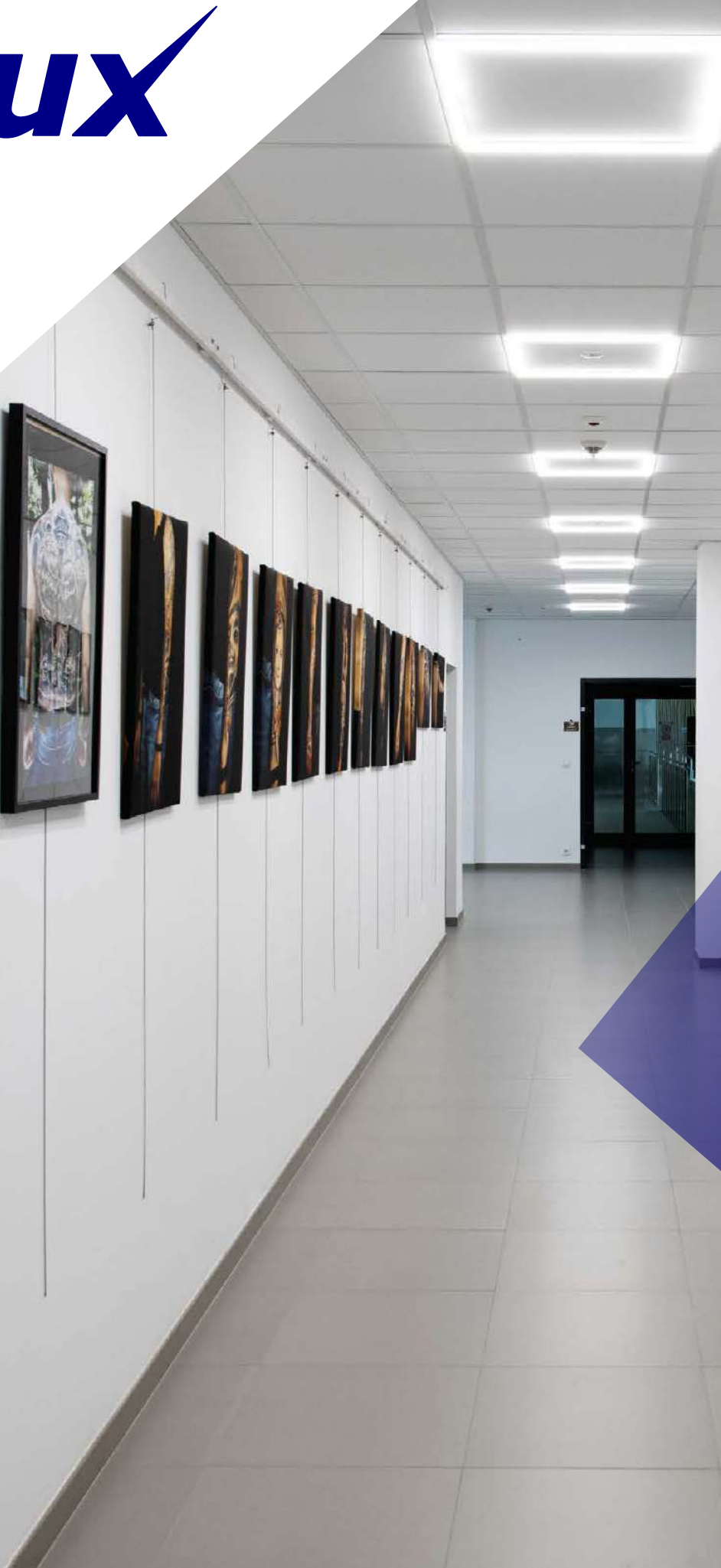



LUMINAIRES TECHNIQUES ET FONCTIONNELS
TECHNICAL AND ARCHITECTURAL FIXTURES

Nous éclairons déjà des nombreux espaces de bureaux et de foyers. Nous nous déployons dans le respect des tendances du marché, et en restant à votre écoute.

Stiamo già illuminando migliaia di appartamenti, e centinaia di uffici ed edifici commerciali.

Ci teniamo aggiornati, sviluppiamo ed aggiorniamo la nostra tecnologia per rimanere al passo e poter soddisfare le tue esigenze e bisogni.



*les données photométriques sont disponibles sur:
dati fotometrici consultabili sul sito:*

► [kanlux.com](https://www.kanlux.com)

Kanlux BLINGO BL

PANNEAUX LED ENCASTRES ► PANNELLO LED DA INCASSO

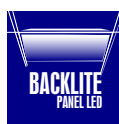

**LOW
UGR**



Les panneaux BLINGO LED nouvelle génération sont des panneaux backlight, équipés d'un connecteur rapide à repiquage, pour relier les panneaux entre eux et faciliter leur installation. Sur ces nouveaux modèles BLINGO LED, l'alimentation est intégrée et totalement scellée aux panneaux Led, facilitant ainsi l'installation dans un cadre saillie Kanlux, de référence ADTR. Ces nouveaux panneaux BLINGO LED sont conçus avec un cadre périphérique rainuré et se caractérisent en outre par une efficacité lumineuse plus élevée que la version précédente de BLINGO.LED

Une garantie de 5 ans accordée conformément aux termes de la déclaration de garantie disponible sur le site d'Internet

Matériau du boîtier: acier

Matériau du diffuseur: matériau plastique

Matériau du panneau/cadre: acier

Kanlux BLINGO LED v2 sono pannelli di ultima generazione retroilluminati. Sono dotati di un connettore rapido che consente la connessione pass-through tra pannelli e accelera la loro installazione. I nuovi modelli della nota famiglia Blingo hanno un alimentatore integrato. Sono inoltre compatibili con le cornici ADTR che ne permettono l'installazione a plafone. I BLINGO LED v2 sono più luminosi ed efficienti dei precedenti modelli.

5 anni di garanzia secondo le condizioni della dichiarazione di garanzia consultabile sul sito Internet

Materiale del corpo: metallo

Diffusore: plastica

Materiale del pannello/della cornice: metallo

	INDEX	BLINGO 24W 4320 60NW	BLINGO U24W 4000 60NW	BLINGO 34W 4080 60NW	BLINGO 34W 3740 60WW	BLINGO 34W 4080 60CW	BLINGO U34W 4080 60NW	BLINGO 34W 4080 120NW	BLINGO U34W 4080 120N	BLINGO 38W 4560 60NW	BLINGO 38W 4560 120NW	BLINGO TN38W 6060 NW	BLINGO TUN48W 6060 NW	BLINGO PU 36W 6262 NW	BLINGO TN24-28W6060NW	BLINGO IPRN38W 6060NW
		37178	37179	37171	37170	37172	37173	37174	37175	37176	37177	33177	33179	33188	33178	33174
SPN PANEL 120	37336							✓	✓		✓					
SPN PANEL 60-62	37335	✓	✓	✓	✓	✓	✓			✓		✓	✓	✓	✓	✓
CLIPS PANEL 120	37338							✓	✓		✓					
CLIPS PANEL 60-62	37337	✓	✓	✓	✓	✓	✓			✓		✓	✓	✓	✓	✓
ADTR 6060 B	27615	✓	✓	✓	✓	✓	✓			✓		✓	✓			
ADTR 6060 SR	27610	✓	✓	✓	✓	✓	✓			✓		✓	✓			
ADTR 6060 W	27613	✓	✓	✓	✓	✓	✓			✓		✓	✓			
ADTR-S 6060 W	27616	✓	✓	✓	✓	✓	✓			✓		✓	✓			
ADTR 12030 B	27614							✓	✓		✓					
ADTR 12030 SR	27612							✓	✓		✓					
ADTR 12030 W	27611							✓	✓		✓					
ADTR-H 6060 B	29845	✓	✓	✓	✓	✓	✓			✓		✓	✓		✓	✓
ADTR-H 6060 SR	29844	✓	✓	✓	✓	✓	✓			✓		✓	✓		✓	✓
ADTR-H 6060 W	29843	✓	✓	✓	✓	✓	✓			✓		✓	✓		✓	✓
ADTR-S-H 6060 W	27617	✓	✓	✓	✓	✓	✓			✓		✓	✓		✓	✓
ADTR-H 76MM 6060 W	33398	✓	✓	✓	✓	✓	✓			✓		✓	✓		✓	✓
ADTR-H 12030 B	33391							✓	✓		✓					
ADTR-H 12030 SR	33392							✓	✓		✓					
ADTR-H 12030 W	33390							✓	✓		✓					
ADTR-H 6262 W	33435													✓		



ADTR W, SR, B

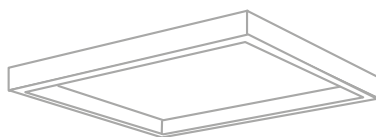

ADTR 6060 - 600 x 600 x 45mm
ADTR-H 6060 - 600 x 600 x 65mm
ADTR-H 6262 - 627 x 627 x 65mm
ADTR-H 76MM - 600 x 600 x 76mm

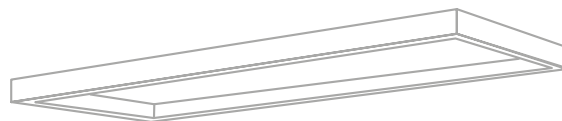

ADTR 12030 - 1200 x 300 x 45mm
ADTR-H 12030 - 1200 x 300 x 65mm

Kanlux

BLINGO CV

PANNEAUX LED DIMMABLES ► PANNELLO LED DA INCASSO



NEW



BLINGO U E125LM 60NW



BLINGO U E125LM 120NW

							Driver [index]
BLINGO U E125LM 30NW	37271	5905339372710	max 21,6	3000	blanc bianco		37272 (600mA, 24W)
BLINGO U E125LM 60NW	37265	5905339372659	max 36	4000\5000	blanc bianco		37269 (850mA, 32W); 37270 (1100mA, 40W)
BLINGO U E125LM 120NW	37266	5905339372666	max 36	4000\5000	blanc bianco		37269 (850mA, 32W); 37270 (1100mA, 40W)

90	≥50000	50000	Ra 80	SMD
IP 20	5÷25 °C	0,5m	≤60/Max36mm	SMD
UGR 19	CE	EAC	UKCA	

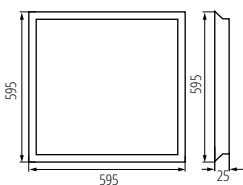

BLINGO U E125LM 60NW

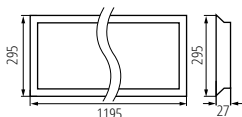

BLINGO U E125LM 120NW



BLINGO U E125LM 30NW



**LOW
UGR**

**5
WARRANTY
5 years**

**PANEL
2020**

**BACKLITE
PANEL LED**

**HIGH
lumen**

Les panneaux Kanlux BLINGO CV sont équipés d'un diffuseur microprismatique qui réduit l'effet d'éblouissement (indice UGR faible). Sa durée de vie est de 50 000 heures, avec une garantie de 5 ans. Attention! Les panneaux Kanlux BLINGO CV ne sont pas livrés avec les drivers inclus. Il convient en effet de choisir le driver répondant aux besoins de l'installation, soit en version dimmable (1-10V ou DALI) soit en version ON/OFF.

Une garantie de 5 ans accordée conformément aux termes de la déclaration de garantie disponible sur le site d'Internet

Panneau LED fourni sans alimentation.

Pour un fonctionnement correct, une alimentation LED appropriée disponible dans l'offre KANLUX est nécessaire

Matériau du boîtier: acier

Matériau du diffuseur: matériau plastique

Matériau du panneau/cadre: acier

I pannelli Kanlux BLINGO CV hanno una struttura microprismatica del diffusore, che riduce l'effetto abbagliante (indice UGR <19). La durata del prodotto è di 50.000 ore e 5 anni di garanzia. I Kanlux BLINGO CV non hanno un alimentatore incluso, possono essere abbinati ad alimentatori dedicati (1-10V o DALI) e ON/OFF

5 anni di garanzia secondo le condizioni della dichiarazione di garanzia consultabile sul sito Internet

Pannello LED senza alimentatore incluso.

Per un funzionamento corretto è necessario un alimentatore LED adeguato disponibile nell'offerta KANLUX

Materiale del corpo: metallo

Diffusore: plastica

Materiale del pannello/della cornice: metallo

BLINGO CV

PANNEAUX LED DIMMABLES ► PANNELLO LED DA INCASSO

CHOIX DRIVERS ► DRIVER



SEC(mA)



BLINGO DALI SET 38W	28515	5905339372727	45	800	DALI
BLINGO DRV42W DALI BK	37267	5905339372697	42	450-1100	DALI
BLINGO DRV40W1-10V BK	37268	5905339372703	40	600-1050	1-10V
BLINGO DRV 32W ON-OFF	37269	5905339372680	32	850	-
BLINGO DRV 40W ON-OFF	37270	5905339372673	40	1100	-
BLINGO DRV 24W ON-OFF	37272	5905339285157	24	600	-

NEW

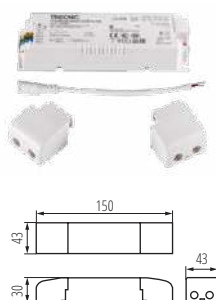

BLINGO DALI SET 38W

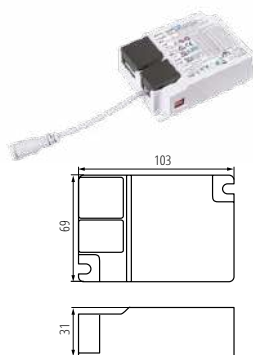

BLINGO DRV40W1-10V BK 37268
BLINGO DRV42W DALI BK 37267

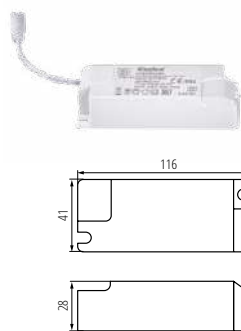

BLINGO DRV 24W ON-OFF 37272
BLINGO DRV 32W ON-OFF 37269
BLINGO DRV 40W ON-OFF 37270

	INDEX	BLINGO U	BLINGO U	BLINGO U
		E125LM 30NW	E125LM 60NW	E125LM 120NW
BLINGO DRV 24W ON-OFF	37272	✓		
BLINGO DRV 32W ON-OFF	37269		✓	✓
BLINGO DRV 40W ON-OFF	37270		✓	✓
BLINGO DRV40W1-10V BK	37268	✓	✓	✓
BLINGO DRV42W DALI BK	37267	✓	✓	✓
BLINGO DALI SET 38W	28515	✓	✓	✓
SPN PANEL 120	37336			✓
SPN PANEL 60-62	37335	✓	✓	
CLIPS PANEL 120	37338			✓
CLIPS PANEL 60-62	37337	✓	✓	
ADTR-H 6060 W	29843		✓	
ADTR-H 12030 W	33390			✓
ADTR-H 3060 W	33393	✓		



CLIPS PANEL 120



SPN PANEL 120

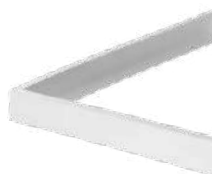

ADTR-H W

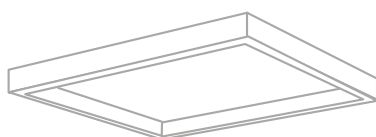

ADTR-H 6060 - 600 x 600 x 65mm



ADTR-H 3060 - 300 x 600 x 65mm



ADTR-H 12030 - 1200 x 300 x 65mm

BRAVO LED

PANNEAUX LED EDGE-LITE ► PANNELLO LED DA INCASSO



BRAVO PU 36W6060



BRAVO PU 28W3060



BRAVO S 40W6060



BRAVO S 40W12030

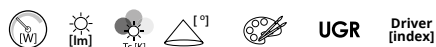

BRAVO PU36W6060NNW	28002	5905339280022	36	4320	4000	110	blanc bianco	<19	28025										
BRAVO PU28W3060NNW	28551	5905339285515	28	3360	4000	90	blanc bianco	<19	28029										
BRAVO S 40W6060NNW	28010	5905339280107	40	4000	4000	110	biały white		28026										
BRAVO S 40W12030NNW	28022	5905339280220	40	4000	4000	110	biały white		28026										

≥15000	30000	≤6m/Maxd&am	Ra 80	SMD	II	IP 20		5÷25	
0,05	0,5	0,5m							

CHOIX DRIVERS ► DRIVERS

BRAVO DRIVER 28W	28029	
BRAVO DRIVER 36W	28025	
BRAVO DRIVER 40W	28026	
BRAVO DALI SET 36W	28508	

IN		OUT		
[V] 220-240V~	[Hz] 50/60		8 cm	
	[mm] 0,75 - 1,5			IP 20



BRAVO DRIVER

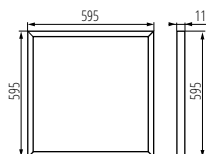

BRAVO 6060

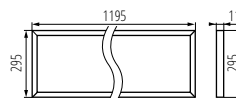

BRAVO 12030

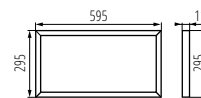

BRAVO 3060

BRAVO LED

PANNEAUX LED EDGE-LITE ► PANNELLO LED DA INCASSO



Pour assurer le fonctionnement des BRAVO LED, il convient de sélectionner le driver adéquat qui n'est pas inclus.

Panneau LED fourni sans alimentation.

Pour un fonctionnement correct, une alimentation LED appropriée disponible dans l'offre KANLUX est nécessaire

Matériau du boîtier: acier

Matériau du diffuseur: matériau plastique

Matériau du panneau/cadre: acier

5 anni di garanzia secondo le condizioni della dichiarazione di garanzia consultabile sul sito Internet
Pannello LED senza alimentatore incluso.

Per un funzionamento corretto è necessario un alimentatore LED adeguato disponibile nell'offerta KANLUX

Materiale del corpo: metallo

Diffusore: plastica

Materiale del pannello/della cornice: metallo

*dotyczy BRAVO PU / only for BRAVO PU



BRAVO S/P GRIP



CLIPS BRAVO S/P



SPN BRAVO S/P



ADTR W, SR; B



PSR 100

	INDEX	BRAVO S/P GRIP		CLIPS BRAVO S/P		SPN BRAVO S/P		ADTR						PSR 100			
		60x60 / 62x62	120x30	60x60 / 62x62	120x30	60x60 / 62x62	120x30	30x60 (SR)	30x60 (W)	30x60 (B)	60x60 (SR)	60x60 (W)	60x60 (B)	120x30 (SR)	120x30 (W)	120x30 (B)	60x60 / 62x62
BRAVO PU36W6060NW W	28002	✓		✓		✓					✓	✓	✓				✓
BRAVO PU28W3060NW W	28551	✓		✓		✓	✓	✓	✓								✓
BRAVO S 40W6060NW W	28010	✓		✓		✓					✓	✓	✓				✓
BRAVO S 40W12030NW W	28022		✓		✓		✓							✓	✓	✓	

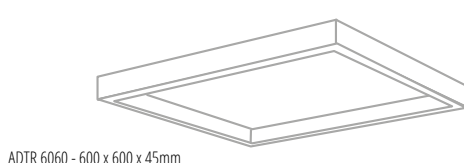

ADTR 6060 - 600 x 600 x 45mm

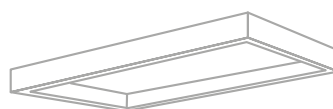

ADTR 3060 - 300 x 600 x 45mm



ADTR 12030 - 1200 x 300 x 45mm

AVAR LED

CADRE LUMINEUX LED ► PLAFONIERA A LED



AVAR 6060 40W-NW



AVAR 6060 40W-CW



AVAR 6262 40W-NW

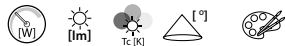

AVAR 6060 40W-NW	26770	5905339267702	40	3600	4000	110	blanc bianco
AVAR 6060 40W-CW	26771	5905339267719	40	3800	6000	110	blanc bianco
AVAR 6262 40W-NW	26773	5905339267733	40	3600	4000	110	blanc bianco
AVAR 6262 40W-WW	26774	5905339267740	40	3400	3000	110	blanc bianco

[V] 220-240 AC	[Hz] 50	[h] ≥15000	[h] 25000	[lm] diffuse ≤ 60 Nachlam	[Ra] 80	[SMD]	[IP] 20	[house icon]
[°C] 5+25	[arrow icon]	[nut icon]	[mm] 0,75	[mm] 0,5m	[CE]	[EAC]	[UKCA]	[recycling icon]

AKCESORIA ► ACCESSORIES

AVAR DALI SET 40W	28512	5905339285126	Ensemble contenant les accessoires et le bloc d'alimentation assurant la communication conforme au protocole DALI (28512) Il set è composto dagli accessori e un alimentatore per la comunicazione secondo il protocollo DALI (28512)					
-------------------	--------------	---------------	---	--	--	--	--	--



Les panneaux à LED sont un élément d'éclairage très populaire dans les intérieurs de bureau. Dans une large mesure, ils ont remplacé les luminaires à grille en raison de leur durabilité, de leur efficacité énergétique et de leur esthétique. Kanlux AVAR LED est une nouvelle version des panneaux à LED dont le déterminant est non seulement la technologie moderne mais également la forme d'un encadré qui fournit une lumière puissante et efficace.

AVAR 62x62 destiné à des dimensions non-standard des systèmes pour plafonds (625mmx625mm)

Matériau du boîtier: alliage en aluminium

Matériau du diffuseur: matériau plastique

Matériau du panneau/cadre: alliage en aluminium

I pannelli LED sono sempre più utilizzati e diffusi. Kanlux AVAR LED è una variante dei classici pannelli LED che si caratterizza per il design ultramoderno della cornice luminosa che emette un'intensa luce. Disponibile nelle tonalità bianco freddo e bianco neutro.

AVAR 62x62 è l'alternativa dalle dimensioni pari a (625mmx625mm)

Materiale del corpo: alluminio

Diffusore: plastica

Materiale del pannello/della cornice: alluminio

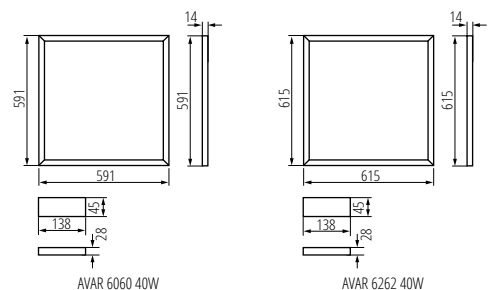



Kanlux REGIS

PAVE LUMINEUX ENCASTRE A GRILLE ALU
▶ PLAFONIERA AD INCASSO CON GRIGLIA



REGIS 3 EVG 418 PT, REGIS 3WS EVG 418 PT

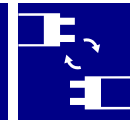

Kanlux REGIS sono dei pavés à grille aluminium encastrables au moyen de clips à ressort et de connecteurs rapides. Les appareils à grilles aluminium sont toujours une solution d'éclairage répandue notamment dans les opérations de rénovation de bureaux ou locaux industriels.

réflecteurs semi-parabolique / culots G13 dissimulés par le réflecteur alu (sauf version: REGIS 3 OPAL, REGIS 3WS OPAL avec diffuseur opal)

alimentation grâce à un connecteur rapide sur le caisson, câble de protection, protection supplémentaire contre le choc électrique (sauf version REGIS 3 OPAL, REGIS 3WS OPAL)

encastrement plafond grâce aux ressorts, connecteur rapide pour l'alimentation, ballast de marque OSRAM classe A2

peinture en poudre
REGIS 3WS équipé d'un ballast à „cathode chaude”.

Matériau du boîtier: acier

Matériau du réflecteur: aluminium

Le Kanlux REGIS sono classiche plafoniere da incasso con diffusore a griglia caratterizzate da un facile e veloce montaggio grazie all'impiego di attacchi a molla e innesti rapidi. Questo tipo di plafoniere continua ad essere una soluzione molto comune per illuminare uffici o spazi industriali.

riflettore a forma di semiparabola / traverse della griglia a forma di "V" / prese delle lampadine fluorescenti

mascherate con riflettore (tranne la versione REGIS 3 OPAL, REGIS 3WS OPAL, dotata di piastra opale)

nella cover vi sono fori che permettono alimentazione passante

conduttore di protezione sulla griglia, che protegge anche contro le scosse elettriche, ad eccezione delle versioni REGIS 3 OPAL e REGIS 3WS OPAL

facile montaggio della griglia su attacchi a molla

attacco rapido per il collegamento dell'alimentazione elettrica, facilitata e velocizzata l'installazione, alimentatore Osram in classe A2

verniciatura a polvere

REGIS 3WS dotato di reattore con "accensione a caldo"

Materiale del corpo: metallo

Materiale del riflettore: alluminio



REGIS 3WS EVG 418 PT



REGIS 3WS OPAL 418 PT



REGIS 3 EVG 418 PT	19730	5905339197306	4 x 18	T8	G13	20	blanc bianco
REGIS 3 OPAL 418 PT	19734	5905339197344	4 x 18	T8	G13	40	blanc bianco
REGIS 3WS EVG 418 PT	25710	5905339257109	4 x 18	T8	G13	20	blanc bianco
REGIS 3WS OPAL 418 PT	25713	5905339257130	4 x 18	T8	G13	40	blanc bianco

[V] 220-240 AC	[Hz] 50						
	EVG BALLAST		CE	EMC	UK		

ACCESSORIA ▶ ACCESSORIES

CLP-REGISVPT	72333	5905339723338	CLP-REGISVPT accessoire clips d'encastrement pour plafond placo-plâtre CLP-REGISVPT set of clip per il fissaggio in controsoffitti in cartongesso.
--------------	-------	---------------	--

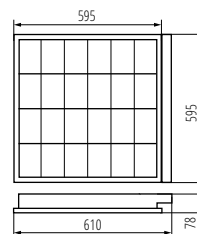

REGIS 3 EVG 418 PT; REGIS 3WS EVG 418 PT

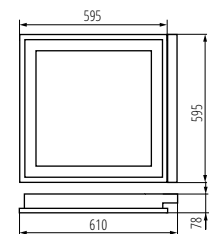

REGIS 3 OPAL 418 PT; REGIS 3WS OPAL 418 PT

Kanlux

REGIS 4LED

PAVE LUMINEUX ENCASTRE A GRILLE
 ► PLAFONIERA AD INCASSO CON GRIGLIA



REGIS 4LED 418 PT



REGIS 4LED OPAL 418PT



REGIS 4LED 418 PT

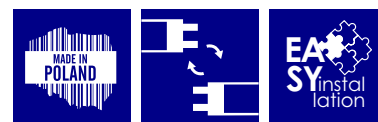

Les luminaires Kanlux REGIS 4LED sont des luminaires à grille aluminium encastrés classiques, adaptés aux tubes LED T8. Ils sont fabriqués au sein de notre usine européenne Kanlux à partir de composants provenant eux aussi de fournisseurs européens. Les appareils à grille constituent une solution d'éclairage toujours en vogue dans certaines opérations de rénovation d'espaces intérieurs de bureau ou locaux industriels.

les luminaires s'utilisent avec des sources lumineuses T8 LED 220-240 V ~; 50/60Hz avec alimentation unilatérale
 luminaires adaptés à la suspension
 montage facile de la trame sur boucles à ressort
 peinture en poudre
 Matériau du boîtier: acier

Le Kanlux REGIS 4LED sono plafoniere da incasso progettate per lampade a LED T8. Sono prodotte in Polonia, realizzate con componenti da fornitori polacchi. Continuano ad essere plafoniere molto diffuse.

gli apparecchi sono progettati per sorgenti T8 LED 220-240 V-; 50/60Hz con alimentazione unilaterale
 possono essere appese
 facile montaggio della griglia su attacchi a molla verniciato a polvere
 Materiale del corpo: metallo



REGIS 4LED OPAL 418PT	19736	5905339197368	4 x max 18	T8 LED	G13	blanc bianco
REGIS 4LED 418 PT	22673	5905339226730	4 x max 18	T8 LED	G13	blanc bianco

[V] 220-240 AC	[Hz] 50	ONE SIDE INPUT	IP 20	5+25
1+2,5	0,5m	CE	ERL	UK

AKCESORIA ► ACCESSORIES

CLP-REGIS\PT	72333	5905339723338	CLP-REGIS\PT accessoire clips d'encastrement pour plafond placo-plâtre CLP-REGIS\PT set di clip per il fissaggio in controsoffitti in cartongesso.
--------------	--------------	---------------	--

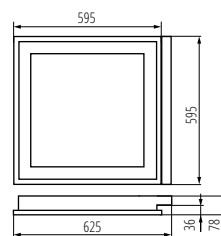

REGIS 4LED OPAL 418PT

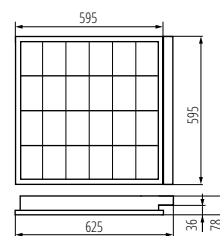

REGIS 4LED 418 PT

Kanlux NOTUS

PLAFONNIER À GRILLE ALU ► LAMPADA CON GRIGLIA



NOTUS 3 EVG 418 NT



NOTUS 3 EVG 236 NT



NOTUS 3 EVG 218 NT



NOTUS 3 EVG 418 NT	19731	5905339197313	4 x 18	T8	G13	blanc bianco
NOTUS 3 EVG 236 NT	19732	5905339197320	2 x 36	T8	G13	blanc bianco
NOTUS 3 EVG 218 NT	19733	5905339197337	2 x 18	T8	G13	blanc bianco
NOTUS 3WS EVG 418 NT	25711	5905339257116	4 x 18	T8	G13	blanc bianco
NOTUS 3WS EVG 236 NT	25712	5905339257123	2 x 36	T8	G13	blanc bianco

[V] 220-240 AC	[Hz] 50			IP 20		 5+25	
	 1+2,5		 0,5m	CE	EMC	UK CA	

AKCESORIA ► ACCESSORIES

ROPE-NT 150	07870	5905339078704	ROPE-NT 150 câble en acier (double) pour la suspension de luminaires, ensemble de 2 pièces ROPE-NT 150 set funicelle in metallo (doppio snodo) per sospensione, 2 pezzi
ROPE-NT 150 SINGLE	07871	5905339078711	ROPE-NT 150 SINGLE câble en acier (unique) pour la suspension de luminaires, ensemble de 2 pièces ROPE-NT 150 set funicelle in metallo per sospensione, 2 pezzi

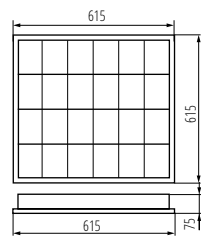

NOTUS 3 EVG 418; NOTUS 3WS EVG 418

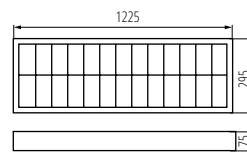

NOTUS 3 EVG 236; NOTUS 3WS EVG 236

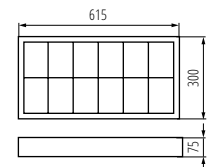

NOTUS 3 EVG 218 NT



Les luminaires Kanlux NOTUS sont des pavés lumineux à grille aluminium pour installation saillie, caractérisés par un montage aisé et rapide. Les luminaires à grille aluminium sont toujours une solution d'éclairage toujours en vogue dans les opérations de rénovation d'espaces intérieurs de bureau ou locaux industriels.

réflecteurs semi-parabolique / culots G13 dissimulés par le réflecteur alu, alimentation grâce à un connecteur rapide sur le caisson, câble de protection, protection supplémentaire contre le choc électrique,

encastrement plafond grâce aux ressorts,

connecteur rapide pour l'alimentation, ballast de marque

OSRAM classe A2

peinture en poudre

NOTUS 3WS équipé d'un ballast à „cathode chaude”.

Matériau du boîtier: acier

Matériau du réflecteur: aluminium

Le Kanlux NOTUS sono plafoniere con griglia dal design classico che si caratterizzano per un facile montaggio. Le plafoniere con griglia continuano ad essere una soluzione molto comune per illuminare uffici o spazi industriali. Ottimi parametri di illuminazione ad un prezzo vantaggioso, una costruzione semplice e la resistenza dei materiali con cui sono realizzati sono i fattori più importanti che le connotano.

riflettore a forma di semiparabola, traverse della griglia a forma di "V"

prese delle lampadine fluorescenti mascherate con riflettore

possono essere appese

alimentatore Osram in classe A2

facile montaggio della griglia su attacchi a molla

attacco rapido per il collegamento dell'alimentazione elettrica, facilita e velocizza l'installazione, verniciatura a polvere

NOTUS 3WS dotato di reattore con "accensione a caldo"

Materiale del corpo: metallo

Materiale del riflettore: alluminio

Kanlux

NOTUS 4LED

PLAFONNIER À GRILLE ALU ► LAMPADA CON GRIGLIA



NOTUS 4LED 418 NT



NOTUS 4LED 236 NT



NOTUS 4LED 218 NT



NOTUS 4LED 418 NT	22671	5905339226716	4 x max 18	T8 LED	G13	blanc bianco
NOTUS 4LED 236 NT	22672	5905339226723	2 x max 36	T8 LED	G13	blanc bianco
NOTUS 4LED 218 NT	22674	5905339226747	2x max 18	T8 LED	G13	blanc bianco

[V] 220-240 AC	[Hz] 50	ONE SIDE INPUT			IP 20		 5+25
		 1+2,5	 0,5m	CE	EAC	UK CA	

AKCESORIA ► ACCESSORIES

ROPE-NT 150	07870	5905339078704	ROPE-NT 150 câble en acier (double) pour la suspension de luminaires, ensemble de 2 pièces ROPE-NT 150 set funicelle in metallo (doppio snodo) per sospensione, 2 pezzi
ROPE-NT 150 SINGLE	07871	5905339078711	ROPE-NT 150 SINGLE câble en acier (unique) pour la suspension de luminaires, ensemble de 2 pièces ROPE-NT 150 set funicelle in metallo per sospensione, 2 pezzi

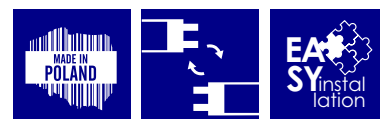

Les luminaires Kanlux NOTUS sont des pavés lumineux à grille aluminium pour installation saillie, caractérisés par un montage aisé et rapide. Les luminaires à grille aluminium sont toujours une solution d'éclairage toujours en vogue dans les opérations de rénovation d'espaces intérieurs de bureau ou locaux industriels.

réflecteur en demi-parabole, lames transversales de la grille en forme V prises des lampes fluorescentes masquées par un réflecteur

montage facile de la grille de défilement sur des crochets à ressort

Matériau du boîtier: acier

Matériau du réflecteur: alliage en aluminium

Kanlux NOTUS 4LED è la versione della classica plafoniera NOTUS progettata per lampade a LED T8. Sono prodotte in Polonia, realizzate con componenti da fornitori polacchi. Le plafoniere con griglia sono una soluzione studiata per gli uffici e gli interni industriali. Le lampade LED contribuiscono a un minore consumo energetico.

gli apparecchi sono progettati per sorgenti T8 LED 220-240 V-; 50/60Hz con alimentazione unilaterale

riflettore a forma di semiparabola, traverse della griglia a forma di "V" prese delle lampadine fluorescenti mascherate con riflettore

possono essere appese

facile montaggio della griglia su attacchi a molla

verniciatura a polvere

Materiale del corpo: metallo

Materiale del riflettore: alluminio

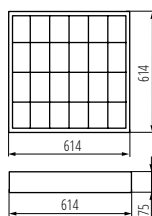

NOTUS 4LED 418 NT

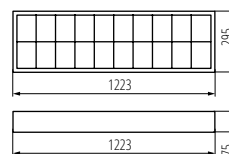

NOTUS 4LED 236 NT

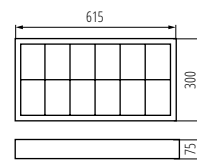

NOTUS 4LED 218 NT

TP STRONG

REGLETTE ETANCHE INDUSTRIELLE ▶ PLAFONIERA LED LINEARE



TP STRONG LED 48W-NW



TP STRONG LED 75W-NW



TP STRONG LED 90W-NW



Kanlux TP STRONG est une réglette étanche à usage industriel grâce à des paramètres techniques optimisés: degré d'étanchéité IP65, résistance mécanique IK08, efficacité lumineuse 135lm/W et angle de diffusion X125°/Y110°, avec une garantie de 5 ans.

Une garantie de 5 ans accordée conformément aux termes de la déclaration de garantie disponible sur le site d'Internet

Matériau du boîtier: matériau plastique

Matériau du diffuseur: PC

Kanlux TP STRONG è una plafoniera stagna adatta ad applicazioni speciali. Tenuta: IP65, resistenza ai danni meccanici: IK08 ed efficienza luminosa: 135lm/W - sono i principali vantaggi di questo apparecchio. Inoltre, l'angolo di distribuzione della luce è 120°. I parametri parlano da soli, e noi aggiungiamo ancora una garanzia di 5 anni.

5 anni di garanzia secondo le condizioni della dichiarazione di garanzia consultabile sul sito www.kanlux.com

Materiale del corpo: plastica

Diffusore: PC

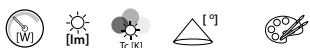

TP STRONG LED 48W-NW	33170	5905339331700	48	6500	4000	X125\Y110	blanc bianco
TP STRONG LED 75W-NW	33171	5905339331717	75	10000	4000	X125\Y110	blanc bianco
TP STRONG LED 90W-NW	33172	5905339331724	90	12000	4000	X125\Y110	blanc bianco

[V] 220-240 AC	[Hz] 50	[h] ≥30000	[h] 50000	[lm/W] ≥60/Noctlam	[Ra] 80	[SMD]	[Symbol]	[Symbol]	IP 65	[Symbol]	[Symbol]	[°C] -20+40
[Symbol]	IK 08	[Symbol]	[Symbol]	[Symbol]	[Symbol]	CE	ERC	PZH	UK CA	[Symbol]		

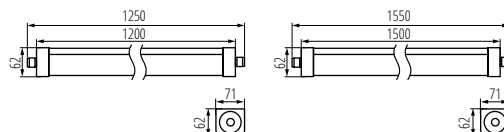

TP STRONG LED 48W

TP STRONG LED 75W; 90W

TP SLIM LED

REGLETTE ETANCHES SLIM ► PLAFONIERA LED LINEARE



TP SLIM LED 50W



TP SLIM LED 40W-NW



TP SLIM TW LED

Kanlux TP SLIM TW LED - presse-étoupes avec connectique rapide inclus, pour une installation en ligne.
 Kanlux TP SLIM TW LED- fitting with pass-through installation, 2 chokes in the fitting, possibility of connecting the fittings in-line.



LED
technology

IP
65

up to

110 lm/W

EASY
installation

Kanlux TP SLIM LED est une reglette étanche slim qui peut être installée en saillie ou en suspension. L'installation est assurée par des pattes de fixation réglables coulissantes et une connectique électrique rapide. Grâce au degré d'étanchéité IP65 et la résistance aux impacts IK 08, il est possible d'utiliser le luminaire dans des endroits comme : les halls industriels, les entrepôts, des parcs de stationnement et des garages

Matériau du boîtier: matériau plastique
 Matériau du diffuseur: matériau plastique

Kanlux TP SLIM LED è una plafoniera stagna che può essere montata a soffitto o a sospensione. Grazie al grado di protezione IP65 e la resistenza agli urti IK 08 è possibile utilizzare l'apparecchio in luoghi come locali industriali, magazzini, parcheggi e garage.

Materiale del corpo: plastica
 Diffusore: plastica



TP SLIM LED 40W-NW	27115	5905339271150	40	4400	4000	X145/Y110	blanc bianco
TP SLIM LED 50W-NW	27116	5905339271167	50	5500	4000	X145/Y110	blanc bianco
TP SLIM TW LED 40W-NW	27117	5905339271174	40	4400	4000	X145/Y110	biały white
TP SLIM TW LED 50W-NW	27118	5905339271181	50	5500	4000	X145/Y110	biały white

[V] 220-240 AC	[Hz] 50	≥20000	25000	Ra 80	SMD	IP 65	
-20+40	IK 08		1-2,5	0,5m			

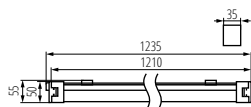

TP SLIM LED 40W-NW

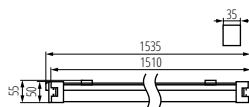

TP SLIM LED 50W-NW

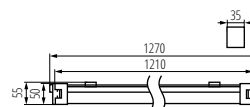

TP SLIM TW LED 40W-NW

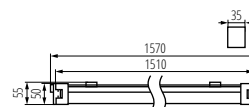

TP SLIM TW LED 50W-NW

MAH LED HI

REGLETTE ETANCHES HIGH ► PLAFONIERA STAGNA LED



MAH LED HI 19W-NW RYF



5
WARRANTY
5 years

IP 65

up to
150 lm/W

Les Kanlux MAH LED HI «high» sont des réglattes étanches conçus pour les utilisateurs les plus exigeants. Elles se caractérisent par une efficacité lumineuse élevée allant de 135 lm/W jusqu'à 150lm/W (pour la version 26W). Les vasques de ces réglattes sont rainurées afin d'augmenter la diffusion lumineuse. En outre, il est possible de les connecter en ligne continue, dans certains cas jusqu'à 15 luminaires (selon le modèle).

Une garantie de 5 ans accordée conformément aux termes de la déclaration de garantie disponible sur le site d'Internet

Matériau du boîtier: PC

Matériau du diffuseur: PC

MAH LED HI rappresenta l'evoluzione del modello MAH LED N. Si caratterizza per un'eccezionale efficienza luminosa fino a 150 lm/W. Kanlux MAH LED HI è facile e veloce da montare e permette il collegamento in linea - che rende possibile l'illuminazione di grandi aree. Negli apparecchi Kanlux MAH LED HI abbiamo utilizzato il paralume ondolato, che ne aumenta il flusso luminoso.

5 anni di garanzia secondo le condizioni della dichiarazione di garanzia consultabile sul sito www.kanlux.com

Materiale del corpo: PC

Diffusore: PC



MAH LED HI 38W-NW RYF



MAH LED HI 48W-NW RYF



MAH LED HI 26W-NW RYF



MAH LED HI 19W-NW RYF	22606	5905339226068	19	2400	4000	110	gris grigio
MAH LED HI 38W-NW RYF	22607	5905339226075	38	5000	4000	110	gris grigio
MAH LED HI 48W-NW RYF	22608	5905339226082	48	6400	4000	110	gris grigio
MAH LED HI 26W-NW RYF	22609	5905339226099	26	3900	4000	110	gris grigio

[V] 220-240 AC	[Hz] 50	 ≥15000	 50000	 diffuse ≤ 60 MacAdam	 Ra 80	 SMD			IP 65		 °C -20+40
	IK 08	 1,5+2,5	 0,5m	CE	ERC	PZH	UK CA				

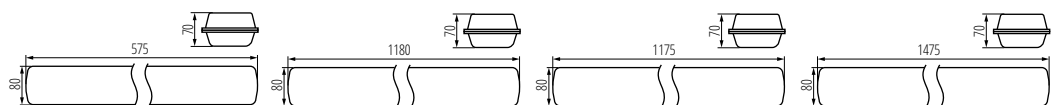

MAH LED HI 19W

MAH LED HI 26W

MAH LED HI 38W

MAH LED HI 48W

Kanlux

MAH LED N

REGLETTE ETANCHES CLASSIQUES ► PLAFONIERA STAGNA LED



MAH-LED N 20W-NW/PC



MAH-LED N 40W-NW/PC



MAH-LED N 50W-NW/PC



Les Kanlux MAH LED N sont des réglettes étanches conçus pour les utilisateurs les plus exigeants. Ils se caractérisent par une efficacité lumineuse élevée allant jusqu'à 105 lm/W et la possibilité de connecter dans certains cas jusqu'à 15 luminaires en ligne continue (selon le modèle), ce qui permet d'éclairer de grandes surfaces.

Matériau du boîtier: PC

Matériau du diffuseur: PC

Kanlux MAH LED N sono apparecchi ermetici progettati per gli utenti più esigenti. Si caratterizzano per l'eccezionale efficienza luminosa fino a 105 lm/W, e inoltre per illuminare grandi aree possono essere combinati in linee composte da massimo 15 apparecchi (a seconda del modello).

Materiale del corpo: PC

Diffusore: PC



MAH-LED N 20W-NW/PC	22603	5905339226037	20	2100	4000	X135V100	gris grigio
MAH-LED N 40W-NW/PC	22604	5905339226044	40	4200	4000	X135V100	gris grigio
MAH-LED N 50W-NW/PC	22605	5905339226051	50	5250	4000	X135V100	gris grigio

[V] 220-240 AC	[Hz] 50	≥15000	30000	ellipsoide ≤ 60 MacKam	Ra 80	SMD	⊗	□	IP 65	🏠	❄️ -20+40
🔧	IK 08	📦	📏 1,5+2,5	📏 0,5m	CE	EAC	PZH	UK CA	📏		

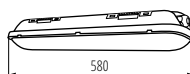

MAH-LED N 20W PC

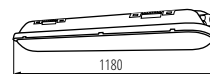

MAH-LED N 40W PC

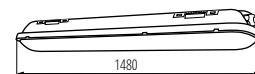

MAH-LED N 50W PC

Kanlux

MAH PLUS 4LED

REGLETTE ÉTANCHE POUR TUBE LED
 ► PLAFONIERA STAGNA PER TUBI LED



MAH PLUS-236/4LED/PC



MAH PLUS-136/4LED/PC



MAH PLUS-158/4LED/PC



MAH PLUS-236/4LED/PC	22800	5905339228000	2 x max 36	T8 LED	G13	gris grigio
MAH PLUS-258/4LED/PC	22801	5905339228017	2 x max 58	T8 LED	G13	gris grigio
MAH PLUS-136/4LED/PC	22802	5905339228024	max 36	T8 LED	G13	gris grigio
MAH PLUS-158/4LED/PC	22803	5905339228031	max 58	T8 LED	G13	gris grigio

[V]	[Hz]	IP	°C	mm	mm
220-240 AC	50	65	5+25	1+2,5	1+2,5
ONE SIDE INPUT	0,5m	CE	ERC	PZH	CSK



Les Kanlux MAH PLUS 4LED sont des réglettes étanches pour tubes LED. Leur principal avantage réside dans le fait qu'ils sont destinés à être équipés de tubes à LED T8 remplaçables, d'une longueur de 1200 mm ou 1500mm, particulièrement appréciés dans l'industrie et le secteur résidentiel.

les luminaires MAH PLUS 4LED/PC sont conçus pour les sources lumineuses T8 LED 220-240 V- ; 50/60 Hz avec alimentation unilatérale

Matériau du boîtier: matériau plastique

Matériau du diffuseur: PC

Matériau des clips: matériau plastique

Kanlux MAH PLUS 4LED è una plafoniera stagna il cui vantaggio principale si traduce nella possibilità di usare le sorgenti luminose a LED T8 con una lunghezza di 1200 mm o 1500 mm. È un'ottima soluzione per applicazioni industriali.

gli apparecchi MAH PLUS 4LED/PC sono progettati per sorgenti T8 LED 220-240 V-; 50/60Hz con alimentazione unilaterale

Materiale del corpo: plastica

Diffusore: PC

Materiale delle clips: plastica

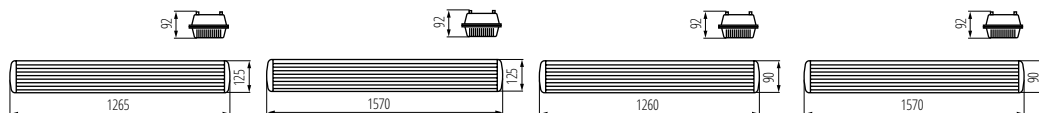

MAH PLUS-236/4LED/PC

MAH PLUS-258/4LED/PC

MAH PLUS-136/4LED/PC

MAH PLUS-158/4LED/PC

Kanlux MAH PLUS

REGLETTE ETANCHE FLUO T8 ► PLAFONIERA STAGNA



MAH PLUS-236-ABS/PC



Les luminaires antipoussières Kanlux MAH PLUS sont extrêmement pratiques en tant qu'éclairage de tunnels, de halls industriels, de garages, d'ateliers, de hangars ou de magasins. Le degré d'intégrité élevé IP65 les rend appropriés pour le montage dans des endroits directement exposés aux conditions atmosphériques.

montage facile du luminaire au support à l'aide des crochets d'encliquetage fournis
plaque de montage suspendue facilitant le raccordement et l'entretien du luminaire
presse-étoupe d'étanchéité utilisé pour l'introduction du cordon d'alimentation

Matériau du boîtier: matériau plastique

Matériau du diffuseur: PC

Matériau des clips: matériau plastique

Matériau du support: métal

Le plafoniere stagne Kanlux MAH PLUS sono ideali per l'illuminazione di gallerie, capannoni industriali, garage, officine, depositi o magazzini. L'elevato grado di protezione IP65 le rende adatte all'installazione in luoghi direttamente esposti agli agenti atmosferici.

facile installation grazie alle comode staffe di montaggio a scatto in dotazione
piastra di montaggio sospesa per facilitare il collegamento e la manutenzione del corpo illuminante

dotata di pressavo

Materiale del corpo: plastica

Diffusore: PC

Materiale delle clips: plastica

Materiale del supporto: metallo



MAH PLUS-236-ABS/PC | **18521** | 5905339185211 | 2 x 36 | T8 | G13 | gris | grigio

[V]	[Hz]			IP					
220-240 AC	50			65					

AKCESORIA ► ACCESSORIES

CL-MAH PLUS	18593	5905339185938	Clips de fixation en plastique (18593) Clip ancoraggio diffusore MAH, CL-MAH PLUS, (18593)
CL-MAH PLUS-INOX	18594	5905339185945	Clips de fixation en inox, (18594) Clip ancoraggio diffusore MAH, CL-MAH PLUS-INOX, (18594)
ROPE-NT 150	07870	5905339078704	ROPE-NT 150 câble en acier (double) pour la suspension de luminaires, ensemble de 2 pièces ROPE-NT 150 set funicelle in metallo (doppio snodo) per sospensione, 2 pezzi
ROPE-NT 150 SINGLE	07871	5905339078711	ROPE-NT 150 SINGLE câble en acier (unique) pour la suspension de luminaires, ensemble de 2 pièces ROPE-NT 150 set funicelle in metallo per sospensione, 2 pezzi

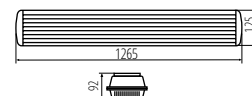

MAH PLUS-236-ABS/PC



Kanlux

MEBA LED IP54

LUMINAIRE PROFILÉS LINÉAIRE LED ► PLAFONIERA LED LINEARE

NEW



MEBA LED 20W IP54 NW

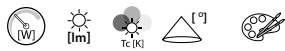

MEBA LED 20W IP54 NW	33892	5905339338921	20	2600	4000	120	blanc bianco
MEBA LED 40W IP54 NW	33893	5905339338938	40	5200	4000	120	blanc bianco

[V] 220-240 AC	[Hz] 50	[W] ≥25000	[h] 50000	[lm] ≤60 Max/Adam	Ra 80	SMD
[°] 0,75-2	[m] 0,5m	IP 54	[°C] -20+40	[°] UK CA	[°] CE	[°] EAC



Kanlux MEBA LED est une gamme de plafonniers saillie étanche IP54 qui se décline en deux longueurs distinctes et de puissances: 615mm (20W) et 1213mm (40W), avec une température de couleurs de 4000°K Équipé d'un diffuseur opal, MEBA LED a une durée de vie 50 000h et une garantie de 5 ans.

Une garantie de 5 ans accordée conformément aux termes de la déclaration de garantie disponible sur le site d'Internet

Matériau du boîtier: acier

Matériau du diffuseur: PC

Kanlux MEBA LED IP54 è una serie di lampade a plafone appartenente alla popolare famiglia Kanlux MEBA. È possibile scegliere tra modelli con lunghezze di 600 mm e 1200 mm. Kanlux MEBA LED IP54 offre un'elevata efficienza luminosa, una durata di 50.000 ore e una garanzia di 5 anni. Un ulteriore vantaggio di questi apparecchi è il livello di protezione IP54 e le due entrate per i cavi che consentono una connessione passante. Il connettore facilita il cablaggio rapido. Il paralume è realizzato in policarbonato e il corpo in metallo.

5 anni di garanzia secondo le condizioni della dichiarazione di garanzia consultabile sul sito Internet
Materiale del corpo: metallo

Diffusore: PC

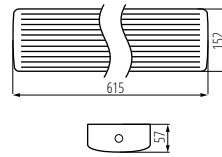

MEBA LED 20W IP54 NW

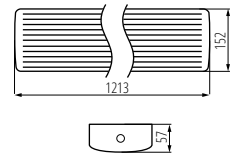

MEBA LED 40W IP54 NW

Kanlux

MEBA 4LED IP54

LUMINAIRE PROFILÉS LINÉAIRE LED ► PLAFONIERA LED LINEARE

NEW



MEBA 4LED 60 IP54 PC



MEBA 4LED 60 IP54 PC	33894	5905339338945	2 x max 9	T8 LED	G13	blanc bianco
MEBA 4LED 120 IP54 PC	33895	5905339338952	2 x max 18	T8 LED	G13	blanc bianco
MEBA 4LED 150 IP54 PC	33896	5905339338969	2 x max 24	T8 LED	G13	blanc bianco

[V] 220-240 AC	[Hz] 50	[W] ONE SIDE INPUT	[h] 50000	IP 54	[°C] -20+40	[°] CE	[°] EAC
[mm] 0,75-2	[m] 0,5m	[°] UK CA	[°] CE	[°] EAC	[°] EAC	[°] EAC	[°] EAC

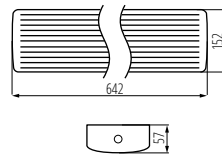

MEBA 4LED 60 IP54 PC

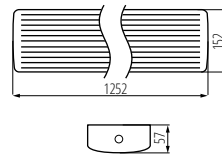

MEBA 4LED 120 IP54 PC

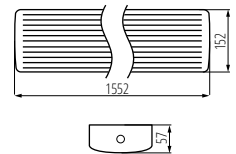

MEBA 4LED 150 IP54 PC

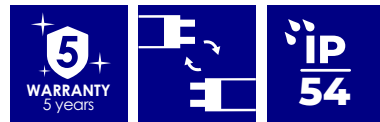

Kanlux MEBA LED est une gamme de plafonniers saillie étanche IP54 destinés à recevoir deux tubes led T8. Équipé d'un diffuseur transparent, il offre une garantie de 5 ans.

Une garantie de 5 ans accordée conformément aux termes de la déclaration de garantie disponible sur le site d'Internet

Matériau du boîtier: acier

Matériau du diffuseur: PC

Kanlux MEBA 4LED IP54 è una serie di di lampade a plafone con una sorgente luminosa sostituibile appartenente alla popolare famiglia d'Kanlux MEBA. Kanlux MEBA LED IP54 offre un'elevata efficienza luminosa, una durata di 50.000 ore e una garanzia di 5 anni. Un ulteriore vantaggio di questi apparecchi è il livello di protezione IP54 e le due entrate per i cavi che consentono una connessione passante. Il connettore facilita il cablaggio rapido. Il paralume è realizzato in policarbonato e il corpo in metallo.

5 anni di garanzia secondo le condizioni della dichiarazione di garanzia consultabile sul sito Internet

Materiale del corpo: metallo

Diffusore: PC

Kanlux MEBA LED

LUMINAIRE PROFILÉS LINÉAIRE LED ► PLAFONIERA LED LINEARE



MEBA LED 22-40W NW/WW



WARRANTY
5 years

LED
technology

4 in 1

up to
125 ^{lm}/_W

Kanlux MEBA LED is a series of surface-mounted luminaires that complement the popular family of Kanlux MEBA luminaires. We have a choice of models with a length of 610mm (12 / 20W) and 1200mm (22 / 40W), each of them has two power options and two light colors options (3000 / 4000K) in one housing. Kanlux MEBA LED means high luminous efficiency (up to 125lm / W), durability of 50,000 hours and a 5-year warranty. An additional advantage of these luminaires is a durable, grooved PC diffuser.

Une garantie de 5 ans accordée conformément aux termes de la déclaration de garantie disponible sur le site d'Internet

Matériau du boîtier: acier

Matériau du diffuseur: PC

Le Kanlux MEBA LED completano la famosa famiglia di plafoniere Kanlux MEBA. Puoi scegliere modelli con una lunghezza di 600mm (12/20W) e 1200mm (22/40W), ognuno di essi ha due potenze e due colori di luce (3000/4000K) in un unico alloggiamento. Kanlux MEBA LED è sinonimo di alta efficienza luminosa (fino a 125lm/W), una durata di 50.000 ore e 5 anni di garanzia. Un ulteriore vantaggio di queste plafoniere è un diffusore in PC resistente e scanalato, antiabbagliamento.

5 anni di garanzia secondo le condizioni della dichiarazione di garanzia consultabile sul sito www.kanlux.com

Materiale del corpo: metallo

Diffusore: PC



MEBA LED 12-20W NW/WW	33890	5905339338907	12\20	1350(WW) 1500(NW) \ 2200(WW) 2300(NW)	3000\4000	120	blanc bianco
MEBA LED 22-40W NW/WW	33891	5905339338914	22\40	2500(WW) 2700(NW) \ 4200(WW) 4400(NW)	3000\4000	120	blanc bianco

[V] 220-240 AC	[Hz] 50	⚡ ≥30000	⌚ 50000	☀️ Ra 80	⚙️ SMD	⚡ IP 20	🏠
🌡️ 5+25	🔧	📦	📏 0,75-2	📏 0,5m	CE	EAC	UK

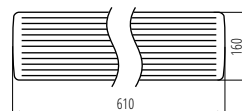

MEBA LED 12-20W NW/WW

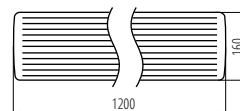

MEBA LED 22-40W NW/WW

Kanlux MEBA 4LED

LUMINAIRE PROFILÉS LINÉAIRE POUR TUBES LED T8
► PLAFONIERA LINEARE PER TUBI LED T8



MEBA 4LED 2X120 PS



Kanlux MEBA 4LED est une version LED du luminaire linéaire Kanlux MEBA. Les tubes LED T8 utilisés garantissent un fonctionnement plus économique et plus long, ce qui se traduit par un confort d'utilisation dans les salons de beauté, salons de coiffure et bureaux.

Matériau du boîtier: matériau plastique, acier

Matériau du diffuseur: PS

La plafoniera MEBA 4LED è destinata all'utilizzo di tubi a LED T8. Alimentazione LED T8 unilaterale.

gli apparecchi sono progettati per sorgenti T8 LED 220-240 V-; 50/60Hz con alimentazione unilaterale

Materiale del corpo: plastica, metallo

Diffusore: PS



MEBA 4LED 2X120 PS	26961	5905339269614	2 x max 36	T8 LED	G13	blanc bianco
MEBA 4LED 2X120 OP PS	26964	5905339269645	2 x max 36	T8 LED	G13	blanc bianco
MEBA 4LED 2X150 OP PS	26965	5905339269652	2 x max 58	T8 LED	G13	blanc bianco

[V] 220-240 AC	[Hz] 50	⚡ ONE SIDE INPUT	⌚ 0,5m	🏠 IP 20	🌡️ 5+25	🔧
📦	📏 1-2,5	📏 0,5m	CE	EAC	UK	🔄

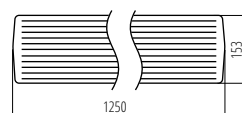

MEBA 4LED 2X120

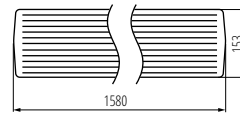

MEBA 4LED 2X150

Kanlux

ALDO 4LED

REGLETTE INDUSTRIELLES TUBES LED T8
▶ PLAFONIERA LINEARE PER TUBI LED T8



ALDO 4LED 1X60; 1X120; 1X150



ALDO 4LED 1X120



ALDO 4LED 1X150



ALDO 4LED 2X120



ALDO 4LED 1X60	26360	5905339263605	max 18	T8 LED	G13	blanc bianco
ALDO 4LED 1X120	26361	5905339263612	max 36	T8 LED	G13	blanc bianco
ALDO 4LED 1X150	26362	5905339263629	max 58	T8 LED	G13	blanc bianco
ALDO 4LED 2X120	26364	5905339263643	2 x max 36	T8 LED	G13	blanc bianco
ALDO 4LED 2X150	26365	5905339263650	2 x max 58	T8 LED	G13	blanc bianco

[V] 220-240 AC	[Hz] 50			IP 20		 5÷25	
	 0,5-2,5	 L N PE ONE SIDE INPUT	 0,5m	CE	EAC	UK CA	

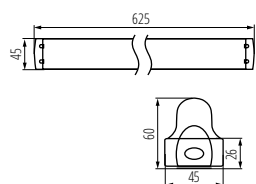

ALDO 4LED 1X60

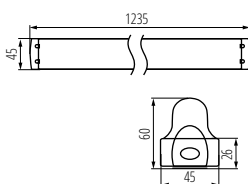

ALDO 4LED 1X120

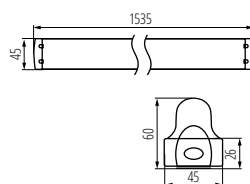

ALDO 4LED 1X150

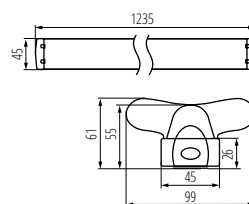

ALDO 4LED 2X120; 2X120R



Kanlux ALDO 4LED est une série de dispositifs d'éclairage adaptés aux lampes à LED T8. Ce sont des luminaires de mur et de plafond, caractérisés par une forme moderne et profilée, qui s'intègrent discrètement dans tous les intérieurs.

Les luminaires s'utilisent avec des sources T8 LED 220-240 V-; 50/60 Hz avec alimentation unilatérale

ALDO R avec réflecteur

Matériau du boîtier: métal, matériau plastique

Kanlux ALDO 4LED è una famiglia di lampade lineari semplici, progettate per funzionare con tubi LED T8. Sono apparecchi da parete e soffitto caratterizzati da una forma moderna e slanciata, che si abbinano discretamente a qualsiasi tipo di arredamento.

gli apparecchi sono progettati per sorgenti T8 LED 220-240 V-; 50/60 Hz con alimentazione unilaterale

Materiale del corpo: metallo, plastica

ALDO 4LED

REGLETTES INDUSTRIELLES TUBES LED T8 ► PLAFONIERA LINEARE PER TUBI LED T8

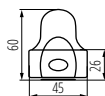
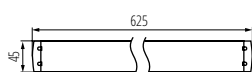

ALDO 4LED 1X60

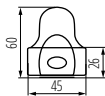

ALDO 4LED 1X120

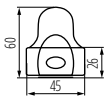
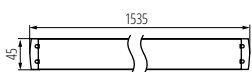

ALDO 4LED 1X150

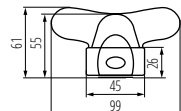

ALDO 4LED 2X120

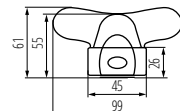
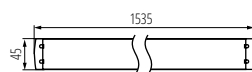

ALDO 4LED 2X150



IPER LED

PLAFONNIER LED ▶ PLAFONIERA LED



IPER LED 10W-NW-O



IPER LED 10W-NW-O	37290	5905339372901	10	1200	4000	blanc bianco	
IPER LED 19W-NW-O	37291	5905339372918	19	2280	4000	blanc bianco	
IPER LED 26W-NW-O	37292	5905339372925	26	3120	4000	blanc bianco	
IPER LED 35W-NW-O	37293	5905339372932	35	4200	4000	blanc bianco	
IPER LED 10W-NW-L	37294	5905339372949	10	1200	4000	blanc bianco	
IPER LED 19W-NW-L	37295	5905339372956	19	2280	4000	blanc bianco	
IPER LED 26W-NW-L	37296	5905339372963	26	3120	4000	blanc bianco	
IPER LED 35W-NW-L	37297	5905339372970	35	4200	4000	blanc bianco	
IPER LED 10W-NW-O-SE	37298	5905339372987	10	1200	4000	blanc bianco	Hyperfréquence a microonde
IPER LED 19W-NW-O-SE	37299	5905339372994	19	2280	4000	blanc bianco	Hyperfréquence a microonde
IPER LED 26W-NW-O-SE	37300	5905339373007	26	3120	4000	blanc bianco	Hyperfréquence a microonde
IPER LED 35W-NW-O-SE	37301	5905339373014	35	4200	4000	blanc bianco	Hyperfréquence a microonde
IPER LED 10W-NW-L-SE	37302	5905339373021	10	1200	4000	blanc bianco	Hyperfréquence a microonde
IPER LED 19W-NW-L-SE	37303	5905339373038	19	2280	4000	blanc bianco	Hyperfréquence a microonde
IPER LED 26W-NW-L-SE	37304	5905339373045	26	3120	4000	blanc bianco	Hyperfréquence a microonde
IPER LED 35W-NW-L-SE	37305	5905339373052	35	4200	4000	blanc bianco	Hyperfréquence a microonde

[V]	[Hz]	[°]	[h]	[h]	ellipse	Ra
220-240 AC	50	120	≥50000	50000	≤ 6x MacAdam	80
Hg	SMD			IP		°C
				65		-20+40
	IK			CE	ERC	
	10		1,5	0,5m		
UK						
CA						



Le plafonnier LED Kanlux IPER offre une Garantie de 5 ans, une durée de vie de 50 000 heures, une efficacité lumineuse élevée de 120lm/W. Les plafonniers LED Kanlux IPER Intègrent des composants Led réputés tel que Samsung 2835 LED. De plus, ils se caractérisent par un degré de résistance élevé à la pénétration d'eau et de poussière IP65, ainsi qu'une résistance mécanique IK10 („antivandal „). En outre, il se décline sous deux formats rond et carré, quatre puissances électrique et une version avec détecteur HF. Le détecteur est pré-réglée en usine .

Une garantie de 5 ans accordée conformément aux termes de la déclaration de garantie disponible sur le site d'Internet

Matériau du boîtier: matériau plastique
Matériau du diffuseur: matériau plastique

Kanlux IPER LED e' una plafoniera con innumerevoli vantaggi fra cui 5 anni di garanzia, durata 50.000 ore e alta efficienza luminosa di 120lm/W. Le Kanlux IPER LED sono dotate di componenti di produttori dalla fama rinomata come ad esempio Samsung 2835 LED Inoltre, queste lampade sono caratterizzato da una resistenza eccezionale con un grado IP65 e la massima resistenza agli urti meccanici IK10 ("prova del vandalo") E' possibile scegliere fra due forme e quattro potenze Disponibili inoltre nella versione con e senza sensore di movimento a microonde (modelli SE).

5 anni di garanzia secondo le condizioni della dichiarazione di garanzia consultabile sul sito Internet

Materiale del corpo: plastica
Diffusore: plastica

Kanlux

IPER LED

PLAFONNIER LED ▶ PLAFONIERA LED



IPER LED 10W-NW-O



IPER LED 19W-NW-O



IPER LED 26W-NW-O



IPER LED 35W-NW-O



IPER LED 10W-NW-L



IPER LED 19W-NW-L



IPER LED 26W-NW-L



IPER LED 35W-NW-L

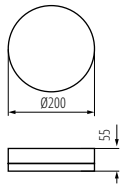

IPER LED 10W-NW-O

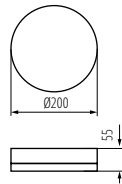

IPER LED 19W-NW-O

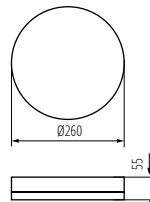

IPER LED 26W-NW-O

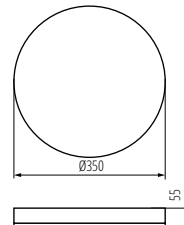

IPER LED 35W-NW-O

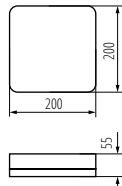

IPER LED 10W-NW-L

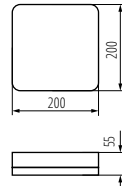

IPER LED 19W-NW-L

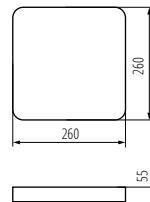

IPER LED 26W-NW-L

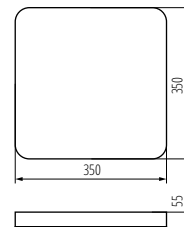

IPER LED 35W-NW-L



Kanlux

BENO LED

PLAFONNIER LED ► PLAFONIERA LED



BENO 18W L-GR; BENO 18W L-SE GR



BENO 18W O-W; BENO 18W O-SE W



BENO 18W O-GR; BENO 18W O-SE GR



BENO 18W L-W; BENO 18W L-SE W



BENO 18W L-GR; BENO 18W L-SE GR



BENO 24W O-W; BENO 24W O-SE W



BENO 24W O-GR; BENO 24W O-SE GR



BENO 24W L-W; BENO 24W L-SE W



BENO 24W L-GR; BENO 24W L-SE GR



Kanlux BENO LED est caractérisé par son design et son effet lumineux esthétique, avec cependant un degré d'étanchéité élevé IP54 et un système d'installation rapide en applique mural ou en plafonnier. Il existe dans une version avec détecteur hyper fréquence (SE comme sensor). Beno Led peut être installé dans n'importe quel local.

Matériau du boîtier: matériau plastique

Matériau du diffuseur: matériau plastique

Le lampade Kanlux BENO hanno un design unico. Sono state progettate e create esclusivamente per il nostro marchio Kanlux e i loro disegni è stato registrato presso l'ufficio brevetti. Kanlux BENO LED ha anche un'elevata resistenza agli agenti atmosferici (tenuta IP54), installazione rapida e semplice sul soffitto o sulla parete e un sensore di movimento tarabile. Kanlux BENO LED è una lampada multifunzione disponibile in più varianti, con o senza sensore di movimento/crepuscolare. Può essere utilizzata praticamente ovunque.

Materiale del corpo: plastica

Diffusore: plastica

BENO LED

PLAFONNIER LED ▶ PLAFONIERA LED



BENO 24W O-W, BENO 24W O-SE W



BENO 18W NW-O-W	32940	5905339329400	18	1550	4000	blanc bianco	
BENO 18W NW-L-W	32942	5905339329424	18	1550	4000	blanc bianco	
BENO 18W NW-O-SE W	32944	5905339329448	18	1550	4000	blanc bianco	Hyperfréquence a microonde
BENO 18W NW-L-SE W	32946	5905339329462	18	1550	4000	blanc bianco	Hyperfréquence a microonde
BENO N 18W NW-O-SE GR	32948	5905339329486	18	1400	4000	graphite grafite	Hyperfréquence a microonde
BENO N 18W NW-L-SE GR	32949	5905339329493	18	1400	4000	graphite grafite	Hyperfréquence a microonde
BENO N 18W NW-O-GR	33348	5905339333483	18	1400	4000	graphite grafite	
BENO N 18W NW-L-GR	33349	5905339333490	18	1400	4000	graphite grafite	
BENO 24W NW-O-W	33340	5905339333407	24	2060	4000	blanc bianco	
BENO 24W NW-O-GR	33341	5905339333414	24	1920	4000	graphite grafite	
BENO 24W NW-L-W	33342	5905339333421	24	2060	4000	blanc bianco	
BENO 24W NW-L-GR	33343	5905339333438	24	1920	4000	graphite grafite	
BENO 24W NW-O-SE W	33344	5905339333445	24	2060	4000	blanc bianco	mikrofalowy microwave
BENO 24W NW-L-SE GR	33345	5905339333452	24	1920	4000	graphite grafite	mikrofalowy microwave
BENO 24W NW-L-SE W	33346	5905339333469	24	2060	4000	blanc bianco	mikrofalowy microwave
BENO 24W NW-L-SE GR	33347	5905339333476	24	1920	4000	graphite grafite	mikrofalowy microwave



[V] 220-240 AC	[Hz] 50	[°] 110	[lm] ≥20000	[h] 20000	[lm] ≤60 Mac/dam	Ra 80	Hg	SMD		
IP 54		[°C] -15+35			[mm] 0,5+1,5	0,5m	CE	EAC	UK CA	

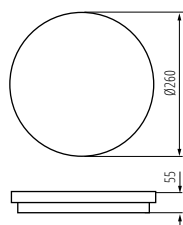

BENO 18W O

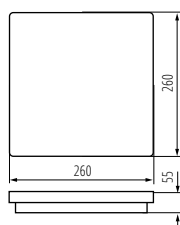

BENO 18W L

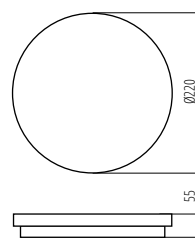

BENO 24W O

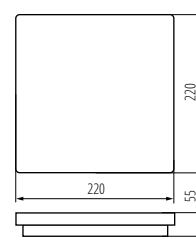

BENO 24W L

VARSO LED

PLAFONNIER LED ▶ PLAFONIERA LED



VARSO LED 18W-O; VARSO LED 18W-O-SE



VARSO LED 18W-O; VARSO LED 18W-O-SE



VARSO LED 18W-L; VARSO LED 18W-L-SE



VARSO LED 24W-O; VARSO LED 24W-O-SE
VARSO HI 36W-NW-O; VARSO HI 36W-NW-O-SE



VARSO LED 24W-L; VARSO LED 24W-L-SE
VARSO HI 36W-NW-L



VARSO LED 18W-WW-O	26440	5905339264404	18	1620	3000	blanc bianco	
VARSO LED 18W-NW-O	26441	5905339264411	18	1700	4000	blanc bianco	
VARSO LED 18W-NW-L	26443	5905339264435	18	1700	4000	blanc bianco	
VARSO LED 24W-WW-O	26444	5905339264442	24	2160	3000	blanc bianco	
VARSO LED 24W-NW-O	26445	5905339264459	24	2280	4000	blanc bianco	
VARSO LED 24W-NW-L	26447	5905339264473	24	2280	4000	blanc bianco	
VARSO HI 36W-NW-O	26448	5905339264480	36	3600	4000	blanc bianco	
VARSO HI 36W-NW-L	26449	5905339264497	36	3600	4000	blanc bianco	
VARSO LED 18W-NW-L-SE	26980	5905339269805	18	1700	4000	blanc bianco	Hyperfréquence a microonde
VARSO LED 18W-NW-O-SE	26981	5905339269812	18	1700	4000	blanc bianco	Hyperfréquence a microonde
VARSO LED 24W-NW-L-SE	26983	5905339269836	24	2280	4000	blanc bianco	Hyperfréquence a microonde
VARSO LED 24W-NW-O-SE	26984	5905339269843	24	2280	4000	blanc bianco	Hyperfréquence a microonde
VARSO HI 36W-NW-O-SE	26985	5905339269850	36	3600	4000	blanc bianco	Hyperfréquence a microonde

[V]	[Hz]	[°]	[h]	[h]	ellipse	Ra	Hg	SMD		IP
220-240 AC	50	120	≥20000	20000	≤ 6x MacAdam	80				54
	[°C]	[mm]	[mm]	[m]	360°	Φuse	CE	EAC	PZH	UK
	-20+35		0,5-2,5	0,5m						

Kanlux VARSO LED

PLAFONNIER LED ► PLAFONIERA LED



Les Kanlux VARSO sont des hublots équipés de LED SMD intégrées. C'est une excellente proposition pour les immeubles de logement collectifs ou logements individuels où sont généralement requis une certaine résistance à l'humidité (IP54).



VARSO LED + SE - variante avec capteur de mouvement

Matériau du boîtier: matériau plastique

Matériau du diffuseur: matériau plastique

Kanlux VARSO LED è una famiglia di plafoniere ermetiche con una sorgente luminosa a LED integrata. Si tratta di un'ottima proposta sia per progetti specifici che per l'uso domestico dove è necessaria una maggiore resistenza all'umidità (IP54). Per l'illuminazione delle aree particolarmente grandi, offriamo Kanlux VARSO HI da 36W con un flusso luminoso fino a 3600 lumen. Ricordate che sono disponibili anche le versioni Kanlux VARSO con rilevatori di movimento (SE).



VARSO LED + SE - versione con sensore di movimento

Materiale del corpo: plastica

Diffusore: plastica

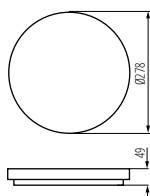

VARSO LED 18W-O

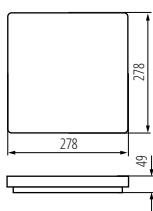

VARSO LED 18W-L

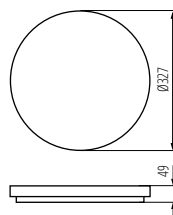

VARSO LED 24W O, VARSO HI 36W O

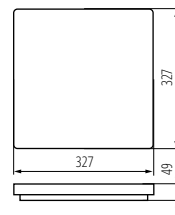

VARSO LED 24W L, VARSO HI 36W L



STIVI LED

PLAFONNIER LED ▶ PLAFONIERA LED



STIVI LED 24W-NW-O, STIVI LED 24W-NW-O-SE



STIVI LED 24W-NW-O, STIVI LED 24W-NW-O-SE STIVI LED 36W-NW-O, STIVI LED 36W-NW-O-SE



Kanlux STIVI LED, hublot Led fournit l'éclairage adéquat pour tout projet de construction. Il se caractérise par une efficacité lumineuse élevée - 130lm/W, un degré d'étanchéité également élevé - IP65 et une résistance aux chocs IK08. Le luminaire LED Kanlux STIVI peut être utilisé à l'extérieur (circulations, coursives, balcons, terrasses), dans les couloirs et les escaliers, ainsi que dans les endroits à humidité élevée (sanitaires, vestiaires, piscines). A noter également les paramètres suivants : Garantie de 5 ans et durée de vie de 50 000 heures, possibilité de choisir un hublot avec ou sans détecteur de mouvement HF. Ce hublot est recommandé pour tout projet de construction neuve ou de opération de rénovation.

Une garantie de 5 ans accordée conformément aux termes de la déclaration de garantie disponible sur le site d'Internet

Matériau du boîtier: PC

Matériau du diffuseur: PC

La plafoniera a LED Kanlux STIVI fornirà luce laddove i dispositivi tradizionali potrebbero guastarsi. È caratterizzata da un'elevata efficienza luminosa - 130lm / W, alto grado di protezione - IP65 e resistenza ai danni IK08. L'apparecchio Kanlux STIVI LED può essere utilizzato all'esterno (balconi, terrazze, patii, gazebo aperti), in corridoi e scale, nonché in luoghi con maggiore umidità (lavanderie, spogliatoi e ambienti con piscine). Si caratterizza per 5 anni di garanzia e 50.000 ore di vita , nonché la possibilità di scegliere fra la versione con o senza il sensore di movimento. È un prodotto ideale per progetti professionali in cui sono richieste elevati parametri tecnici ma è altrettanto valido per un uso domestico.

5 anni di garanzia secondo le condizioni della dichiarazione di garanzia consultabile sul sito Internet

Materiale del corpo: PC

Diffusore: PC



STIVI LED 24W-NW-O	35000	5905339350008	24	3120	4000	blanc bianco	
STIVI LED 24W-NW-O-SE	35001	5905339350015	24	3120	4000	blanc bianco	Hyperfréquence a microonde
STIVI LED 36W-NW-O	35002	5905339350022	36	4680	4000	blanc bianco	
STIVI LED 36W-NW-O-SE	35003	5905339350039	36	4680	4000	blanc bianco	Hyperfréquence a microonde

[V]	[Hz]	[°]	[h]	[h]	[lm]	Ra	Hg	SMD	IK	IP
220-240 AC	50	110	≥30000	50000	≤ 6x Mac/kdam	80			08	65
[-20+40]	IK	08	0,5-2,5	0,5m	360°	CE	ERL	UK		

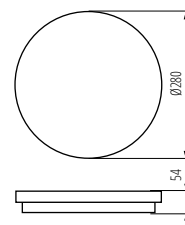

STIVI LED 24W

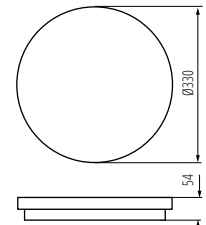

STIVI LED 36W

Kanlux

ORTE LED

PLAFONNIER LED ▶ PLAFONIERA LED



ORTE LED 18W-NW-O



ORTE LED 18W-O, ORTE LED 18W-O-SE

ORTE LED 24W



ORTE LED 18W-NW-O	29160	5905339291608	18	1600	4000	blanc bianco
ORTE LED 24W-NW-O	29161	5905339291615	24	2200	4000	blanc bianco
ORTE LED 18W-NW-O-SE	29162	5905339291622	18	1600	4000	blanc bianco Hyperfréquence a microonde
ORTE LED 24W-NW-O-SE	29163	5905339291639	24	2200	4000	blanc bianco Hyperfréquence a microonde

[V] 220-240 AC	[Hz] 50	[°] 120	[h] ≥20000	[h] 20000	[lm] ≤6x MacKdram	[Ra] 80	[Hg]	[SMD]	[RoHS]	[REACH]
IP 54	[°C] -20÷35	[mm] 0,75±2,5	[mm] 0,5m	[CE]	[EAC]	[UK CA]	[Recycling]			



Kanlux ORTE LED est une nouvelle famille de plafonniers où une attention particulière est portée au design et à la facilité d'installation. Pour plus de confort, nous vous proposons également des versions avec détecteur de mouvement.

Matériau du boîtier: matériau plastique
Matériau du diffuseur: matériau plastique



Kanlux ORTE LED è una nuova famiglia di plafoniere, dove una particolare attenzione è stata rivolta al design e alla facilità di installazione. Per ulteriore comodità vi offriamo anche versioni con rilevatore di movimento.



Materiale del corpo: plastica
Diffusore: plastica

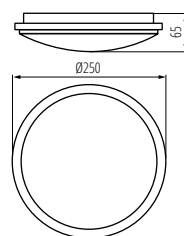

ORTE LED 18W

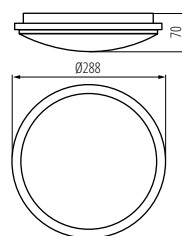

ORTE LED 24W

Kanlux DABA PRO

PLAFONNIER LED ▶ PLAFONIERA LED



DABA PRO 25W NW-B



Kanlux DABA PRO est un plafonnier étanche. Il existe en version sans détecteur de mouvement (25W) et une version avec détecteur (26W), ainsi qu' en deux coloris de finition : blanc et noir. Le hublot Kanlux DABA PRO est étanche selon la norme IP65, donc particulièrement résistant aux conditions atmosphériques extérieures. Il est également résistant aux chocs IK10 et offre une protection supplémentaire anti-vandale puisque son ouverture est impossible sans outil (fourni dans le packaging). Les hublots Kanlux DABA PRO offrent également la possibilité d'un raccordement MAITRE → ESCLAVE, c'est-à-dire que le premier luminaire qui détecte un mouvement peut déclencher l'allumage ou l'extinction de l'ensemble de la ligne lumineuse. La haute qualité de fabrication des luminaires Kanlux DABA PRO est confortée par une garantie de 5 ans et une durée de vie 50 000 h.

Une garantie de 5 ans accordée conformément aux termes de la déclaration de garantie disponible sur le site d'Internet

Matériau du boîtier: matériau plastique

Matériau du diffuseur: PC

Le Kanlux DABA PRO sono plafoniere per uso professionale. È possibile scegliere tra la versione senza sensore di movimento (25W) e quella con sensore (26W). Disponibili in due colori: bianco e nero. Kanlux DABA PRO ha un grado di protezione IP65 ed un'alta resistenza agli urti i IK10. Le plafoniere Kanlux DABA PRO possono essere collegate tra loro secondo il principio MASTER → SLAVE, ovvero il primo (primo e ultimo) apparecchio con sensore controllano tutti gli apparecchi intermedi. L'alta qualità delle plafoniere Kanlux DABA PRO è assicurata da una garanzia di 5 anni.

5 anni di garanzia secondo le condizioni della dichiarazione di garanzia consultabile sul sito www.kanlux.com

Materiale del corpo: plastica

Diffusore: PC

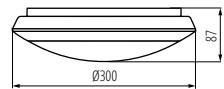

DABA PRO 25W



DABA PRO 25W NW-B	19065	5905339190659	25	2800	4000	noir nero
DABA PRO 26W NW-SE-W	19066	5905339190666	26	2800	4000	blanc bianco Hyperfréquence a microonde

[V] 220-240 AC	[Hz] 50	[°] 115	[h] ≥25000	[h] 50000	[Ra] Ra ≤ 6x MacAdam	[Ra] 80	[Hg]	[SMD]	[IP]	[IK]	[mm]	[mm]	[W]	[lm]	[°]	[CE]
IP 65																
UK CA																

Kanlux DABA N LED SMD

PLAFONNIER LED ▶ PLAFONIERA LED



DABA N LED SMD DL-16W



PRODUKT Z ATESTEM



Le hublot Kanlux DABA N à haute efficacité énergétique permet de réduire les coûts de consommation d'énergie grâce aux capteurs de mouvement et de crépuscule utilisés. Par conséquent, il ne brille que lorsque c'est nécessaire. De plus, ses paramètres (IP66, IK10) permettent de le monter pratiquement n'importe où. Grâce à sa fonction STAND BY DIMMING, après un laps de temps sans mouvement, le plafonnier entre en mode veille en abaissant son flux lumineux jusqu'à 20%.

Matériau du boîtier: PC

Matériau du diffuseur: PC

L'apparecchio Kanlux DABA N offre la possibilità di ridurre i costi energetici utilizzando sensori di movimento e crepuscolo. Ciò significa che si accende solo quando è necessario. Inoltre, i suoi parametri (IP66, IK10) consentono il montaggio praticamente in qualsiasi luogo! Grazie alla funzione STAND BY DIMMING, senza rilevare il movimento per un tempo programmato, la plafoniera passa in modalità stand-by riducendo il flusso luminoso a 20%.

Materiale del corpo: PC

Diffusore: PC

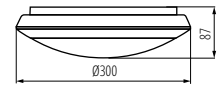

DABA N LED SMD DL-16W



DABA N LED SMD DL-16W	19062	5905339190628	16	1300	4000	blanc bianco Hyperfréquence a microonde
-----------------------	--------------	---------------	----	------	------	---

[V] 220-240 AC	[Hz] 50	[°] 120	[h] ≥20000	[h] 40000	[Ra] Ra ≤ 6x MacAdam	[Ra] 80	[Hg]	[SMD]	[IP]	[IK]	[mm]	[mm]	[W]	[lm]	[°]	[CE]

Kanlux TYBIA LED

PLAFONNIER LED ▶ PLAFONIERA LED



TYBIA LED 38W-NW



TYBIA LED 38W GY, SE



TYBIA LED 28W GY, SE



TYBIA LED 38W B, SE



TYBIA LED 28W B, SE



Kanlux TYBIA LED est un luminaire d'éclairage général dans lequel des diodes SMD sont utilisées. L'installation du luminaire TYBIA LED dans les couloirs, les cages d'escaliers, les locaux sociaux ou fonctionnels garantit des économies substantielles liées non seulement à la consommation d'énergie, mais également à son fonctionnement à long terme et sans entretien.

Une garantie de 5 ans accordée conformément aux termes de la déclaration de garantie disponible sur le site d'Internet
Matériau du boîtier: alliage en aluminium
Matériau du diffuseur: PMMA

Kanlux TYBIA LED è una plafoniera a diodi LED SMD. Il montaggio dell'apparecchio TYBIA LED in corridoi, scale, sale ristoro o ripostigli è una garanzia di risparmio, non solo in termini di consumo energetico ma anche in relazione al suo funzionamento a lungo termine e senza manutenzione.

5 anni di garanzia secondo le condizioni della dichiarazione di garanzia consultabile sul sito www.kanlux.com
Materiale del corpo: alluminio
Diffusore: PMMA

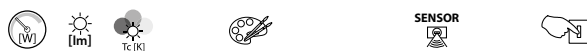

TYBIA LED 38W-NW	24640	5905339246400	38	3800	4000	gris \ blanc grigio \ bianco	≥20000
TYBIA LED 38W-NW-SE	24641	5905339246417	38	3800	4000	gris \ blanc grigio \ bianco	Hyperfréquence a microonde ≥20000
TYBIA LED 38W-NW-B	24642	5905339246424	38	3800	4000	noir nero	≥20000
TYBIA LED 38W-NW-SE B	24643	5905339246431	38	3800	4000	noir nero	Hyperfréquence a microonde ≥20000
TYBIA M 25W-NW-GY	24644	5905339246448	25	2600	4000	gris grigio	≥15000
TYBIA M 25W-NW-B	24645	5905339246455	25	2600	4000	noir nero	≥15000
TYBIA M 25W-NW-SE-GY	24646	5905339246462	25	2600	4000	gris grigio	Hyperfréquence a microonde ≥15000
TYBIA M 25W-NW-SE-B	24647	5905339246479	25	2600	4000	noir nero	Hyperfréquence a microonde ≥15000

[V] 220-240 AC	[Hz] 50	[°] 110	[h] 30000	Ra 80	Hg	SMD	IP 20
House icon	5+25	Mounting icon	Box icon	1-2,5	0,5m	CE, EAC, UK CA	Recycling icon

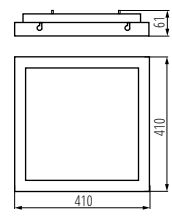

TYBIA LED 38W

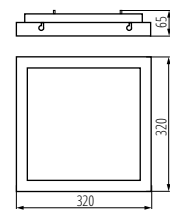

TYBIA LED 25W

Kanlux

JURBA DL

PLAFONNIER À SOURCE LUMINEUSE REMPLAÇABLE
 ► PLAFONIERA CON LAMPADINA SOSTITUIBILE



JURBA DL-2180



Le luminaire hermétique Kanlux JURBA se caractérise par une qualité parfaite. Le luminaire peut être monté au mur et au plafond, à l'intérieur et à l'extérieur des bâtiments. Les luminaires Kanlux JURBA ont un degré accru de résistance à la poussière et à l'humidité - IP44.

Matériau du boîtier: acier

Matériau du diffuseur: PC

La plafoniera ermetica Kanlux JURBA è il sinonimo di un'elevata qualità di manifattura. L'apparecchio può essere montato sia a parete che sul soffitto, sia all'esterno che all'interno. Gli apparecchi Kanlux JURBA si caratterizzano per l'elevato grado di protezione da polveri e acqua - IP44.

Materiale del corpo: metallo

Diffusore: PC



JURBA DL-2180



JURBA DL-218L



JURBA DL-2180	08980	5905339089809	2 x max 18	CFL\LED	E27	nickel satiné nichel satinato
JURBA DL-218L	08981	5905339089816	2 x max 18	CFL\LED	E27	nickel satiné nichel satinato

[V] 220-240 AC	[Hz] 50	IP 44		[°C] -10+35			
 1-2,5	 0,1m		CE	ERC	UK	CA	

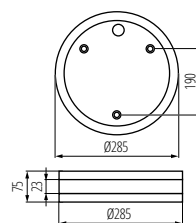

JURBA DL-2180

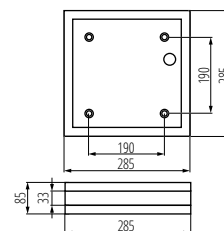

JURBA DL-218L

Kanlux

PIRES DL

PLAFONNIER À SOURCE LUMINEUSE REMPLAÇABLE
 ► PLAFONIERA CON LAMPADINA SOSTITUIBILE



PIRES DL-600



PIRES DL-600 NS



PIRES ECO DL-250



PIRES ECO DL-250 NS



Kanlux PIRES est un plafonnier d'aspect minimaliste équipé d'un capteur de mouvement à micro-ondes, doté d'une portée de détection de mouvement de 9 m. L'avantage du luminaire est également la possibilité de régler le temps d'éclairage entre 8 secondes et 12 minutes.

équipé d'un capteur de mouvement à micro-ondes (8810, 19000)
 angle horizontal maximal du capteur de mouvement de 360°
 angle vertical maximal du capteur de mouvement de 140°
 possibilité de régulation de temps d'éclairage de 8 s. à 12 min.
 portée maximale de détection de mouvement de 9 m
 détection de mouvement de 0,3...3m/s (1...10km/h), plage de réglage de la sensibilité 2...2000lx
 Matériau du boîtier: matériau plastique

Kanlux PIRES è una plafoniera dal design minimalista, disponibile con e senza sensore di movimento a microonde con portata di rilevamento di movimento pari a 9 metri. Il vantaggio dell'apparecchio è anche la possibilità di regolare il tempo di illuminazione da 8 sec. a 12 min.

plafoniere PIRES DL-60 NS, PIRES ECO DL-250 NS - senza sensore di movimento
 plafoniere PIRES DL-600, PIRES ECO DL-250 - con sensore di movimento a microonde
 angolo di rilevamento orizzontale 360°
 angolo di rilevamento verticale 140°
 tempo di accensione tarabile fra 8 secondi e 12 minuti
 distanza di rilevamento massima: 9 metri
 Materiale del corpo: plastica



Matériau du diffuseur

Modèle	Code	Code produit	Max	Source lumineuse	Base	Matériau du diffuseur	Couleur	Technologie
PIRES DL-600	08810	5905339088109	max 60	GLS\CFL\LED	E27	verre vetro	blanc bianco	Hyperfréquence a microonde
PIRES DL-600 NS	08811	5905339088116	max 60	GLS\CFL\LED	E27	verre vetro	blanc bianco	
PIRES ECO DL-250	19000	5905339190000	max 25	CFL\LED	E27	matériau plastique plastica	blanc bianco	Hyperfréquence a microonde
PIRES ECO DL-250 NS	19001	5905339190017	max 25	CFL\LED	E27	matériau plastique plastica	blanc bianco	

[V] 220-240 AC	[Hz] 50	IP 44	ES 5+35	UK CA
[mm] 1-2,5	[m] 0,5m	CE	EAC	UK CA

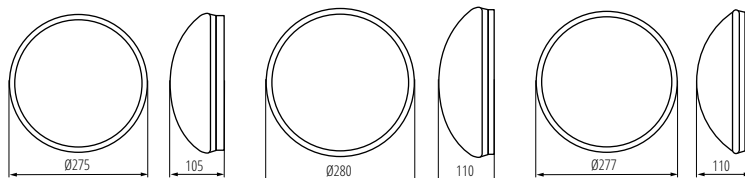

PIRES DL-600

PIRES DL-600 NS

PIRES ECO DL-250; PIRES ECO DL-250 NS

Kanlux FOGLER LED

PLAFONNIER LED ► PLAFONIERA LED



FOGLER LED 14W-NW



Le plafonnier Kanlux FOGLER LED équipé d'un détecteur de mouvement est parfaitement adapté à l'éclairage des cages d'escaliers, des locaux techniques, des locaux de stockage, des sous-sols, ainsi que des garages et des entrées de maisons individuelles.

Matériau du boîtier: acier

Matériau du diffuseur: PC

La plafoniera Kanlux FOGLER LED con il sensore di movimento è ideale per illuminare scale, locali di servizio di edifici condominiali, ripostigli, scantinati nonché garage e vialetti di case unifamiliari.

Materiale del corpo: metallo

Diffusore: PC



FOGLER LED 14W-NW | 18121 | 5905339181213 | 14 | 800 | 4000 | blanc | bianco | PIR

[V] 220-240 AC	[Hz] 50	[°] 110	[h] ≥15000	[h] 20000	[lx] ≤6lx Max/dam	[°C] Ra 80	[SMD]	[E]	[IP] 20	[°C] 5+25
[mm] 0,5-2,5	[m] max 6	[s] - [min] 360	[lx] 10-5	[lx] 5-2000	[m] 0,5m	[lm] 57	[CE]	[EAC]	[UKCA]	[Down Arrow]

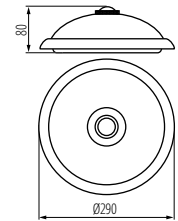

FOGLER LED 14W-NW

Kanlux FOGLER DL

PLAFONNIER À SOURCE LUMINEUSE REMPLAÇABLE ► PLAFONIERA CON LAMPADINA SOSTITUIBILE



FOGLER DL-2400



Le plafonnier Kanlux FOGLER DL équipés d'un culot pour source lumineuse remplaçable est parfaitement adapté aux cages d'escalier, sous-sols, greniers et autres locaux de ce type. Son détecteur de mouvements intégré fonctionne sur une plage horizontale de 360° et garantit que le luminaire s'allume exactement là où vous en avez besoin.

équipé d'un capteur de mouvement

angle horizontal maximal du capteur de mouvement de 360°

angle vertical maximal du capteur de mouvement de 120°

possibilité de régulation de temps d'éclairage de 5 s. à 5 min.

portée maximale de détection de mouvement de 8 m

détection de mouvement de 0,3...3m/s (1...10km/h)

Matériau du boîtier: acier

Matériau du diffuseur: verre

La plafoniera Kanlux FOGLER DL con lampadina intercambiabile è una soluzione ideale per scale, cantine, soffitte e altri locali di questo tipo. Un sensore integrato con un angolo massimo (360°) per il rilevamento del movimento fa sì che l'apparecchio si accenda esattamente quando serve la luce.

senso di movimento a 360°

angolo verticale di rilevamento 120°

tarabile fra 5 secondi e 5 minuti

distanza massima di rilevamento: 8 metri

Materiale del corpo: metallo

Diffusore: vetro



FOGLER DL-2400 | 18120 | 5905339181206 | 2 x max 40 | GLS\CFL\LED | E27 | blanc | bianco

[V] 220-240 AC	[Hz] 50	[IP] 20	[h] ≥15000	[h] 20000	[°C] 5+25	[mm] 1-2,5	[m] max 8
[PIR]	[s] - [min] 12-5	[lx] 3-2000	[m] 0,5m	[E]	[EAC]	[UKCA]	[Down Arrow]

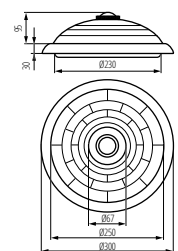

FOGLER DL-2400

Kanlux SANSO LED

PLAFONNIER LED ▶ PLAFONIERA LED



SANSO LED 15W-NW-SE

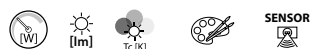

SANSO LED 15W-NW-SE | 26520 | 5905339265203 | 15 | 1250 | 4000 | blanc | bianco | PIR

[V]	[Hz]	[°]	[h]	[h]	[lm]	Ra	Hg	SMD	[m]	[W]	IP
220-240 AC	50	120	≥10000	15000	≤60 MacK/dam	80			0,5m	83	44
[°C]	[mm²]	[m]	[lx]	[s]	[min]	[lx]	[lx]	[lx]	[lx]	[lx]	[lx]
-20+35	0,5-1,5	max 6	H160	5-5	8-2000	0,5m	Im	W	83	13	
[lm] Glare	[°]	[W]	CE	ERC	UK	CA					
2000	360°	125									



Le plafonnier Kanlux SANSO LED avec capteur de mouvement PIR intégré vous permet de le personnaliser selon vos besoins. Il se caractérise également par une étanchéité accrue (IP 44), grâce à laquelle son intérieur est protégé contre les poussières.

Une garantie de 5 ans accordée conformément aux termes de la déclaration de garantie disponible sur le site d'Internet

Matériau du boîtier: PC

Matériau du diffuseur: PC

La plafoniera Kanlux SANSO LED è dotata di un sensore di movimento PIR integrato. È caratterizzata da un grado di protezione IP44 ed una forma semplice.

5 anni di garanzia secondo le condizioni della dichiarazione di garanzia consultabile sul sito www.kanlux.com

Materiale del corpo: PC

Diffusore: PC

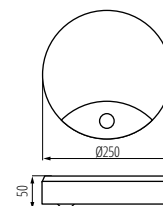

SANSO LED 15W-NW-SE

Kanlux MARC DL

PLAFONNIER À SOURCE LUMINEUSE REMPLAÇABLE ▶ PLAFONIERA CON LAMPADINA SOSTITUIBILE



MARC DL-60

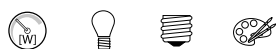

MARC DL-60 | 07015 | 5905339070159 | max 60 | GLS\CFL\LED | E27 | blanc | bianco

[V]	[Hz]	[m]	IP	[°C]	[m]	[lx]
220-240 AC	50	54		-10+35	1-1,5	0,5m
[lx]	[lx]	[lx]	[lx]	[lx]	[lx]	[lx]
1-1,5	0,5m	CE	ERC	UK	CA	



Le plafonnier Kanlux MARC DL se caractérise par une conception simple, avec toutefois une résistance très élevée aux chocs (IK10). La haute résistance à la poussière, ainsi qu'à l'humidité (IP54) et aux rayons UV sont les arguments principaux de ce luminaire.

haute résistance au rayonnement UV (PIK10)

haute résistance aux chocs

Matériau du boîtier: PC

Matériau du diffuseur: PC

La plafoniera Kanlux MARC DL è un design semplice unito ad un'elevata resistenza agli urti (IK10). L'elevata resistenza alle polveri, all'umidità (IP54) e ai raggi UV sono gli ulteriori vantaggi di questo apparecchio.

Materiale del corpo: PC

Diffusore: PC

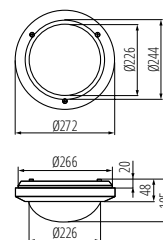

MARC DL-60

Kanlux ERTON

PLAFONNIER À SOURCE LUMINEUSE REMPLAÇABLE ▶ PLAFONIERA CON LAMPADINA SOSTITUIBILE



ERTON 140 OP-W



ERTON 140 OP-W	35770	5905339357700	max 15	GLS\CFL\LED	E27	blanc bianco
ERTON 240 OP-W	35771	5905339357717	2x max 15	GLS\CFL\LED	E27	blanc bianco

[V] 220-240 AC	[Hz] 50	□	IP 44	🏠	🌡️ -25+35	🔧
📏 0,5m	💡	🔌	CE	ERL	UK	♻️



Le plafonnier Kanlux ERTON est une solution esthétique pour les lieux à forte humidité. Les deux modèles de luminaires ont la possibilité d'utiliser des sources lumineuses puissantes - jusqu'à 15W, le modèle 240 OP-W pouvant accueillir deux sources. Ces luminaires, grâce à leur degré de protection IP44, sont adaptés aux utilisations professionnelles, domestiques et commerciales.

Matériau du boîtier: matériau plastique

Matériau du diffuseur: PC

La plafoniera Kanlux ERTON è una soluzione estetica per luoghi umidi. Disponibile in due potenze: 15W o 40 watt con due lampadine. Questi apparecchi, grazie al grado di protezione IP44, sono adatti per applicazioni professionali, domestiche e commerciali.

Materiale del corpo: plastica

Diffusore: PC

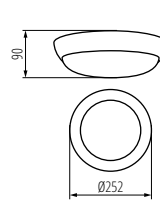

ERTON 140 OP-W

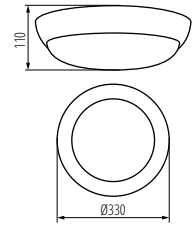

ERTON 240 OP-W

Kanlux PLAFMIN

PLAFONNIER ▶ PLAFONIERA



PLAFMIN O



PLAFMIN O	25690	5905339256904	max 40	E27	GLS\CFL\LED	blanc bianco
-----------	--------------	---------------	--------	-----	-------------	----------------

[V] 220-240 AC	[Hz] 50	□	IP 20	🏠	🌡️ 5+25	📦
📏 1+2,5	📏 0,5m	CE	ERL	UK	♻️	



Kanlux PLAFMIN est le plafonnier le plus universel dans notre offre. Il se caractérise par une forme neutre d'hémisphère, le manque de tout élément de décoration et la possibilité de personnaliser la source de lumière. Il peut être utilisé dans chaque espace (IP20), nous le recommandons tout particulièrement pour les hôtels, les restaurants et les espaces privés dans le style scandinave ou minimaliste.

Matériau du boîtier: matériau plastique

Matériau du diffuseur: matériau plastique

Kanlux PLAFMIN è la plafoniera più universale della nostra offerta. È bianca, ha la forma di semisfera, è priva di ornamenti e permette di abbinare la sorgente luminosa in piena autonomia. Può essere utilizzata in qualsiasi interno (IP20), è particolarmente consigliata per alberghi, ristoranti e interni residenziali.

Materiale del corpo: plastica

Diffusore: plastica

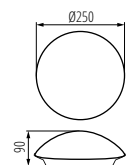

PLAFMIN O

Kanlux HERMI

HUBLOTS ► LAMPADA „TARTARUGA“



HERMI 7063NB

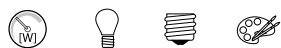

HERMI 7063NB | **70524** | 5905339705242 | max 100 | GLS\CFL\LED | E27 | blanc | bianco

[V] 220-240 AC	[Hz] 50	[mm] 1-1,5	IP 54	[-20+25]	UK CA
[mm] 1-1,5	[mm] 1-1,5	[mm] 1-1,5	CE	ERC	UK CA

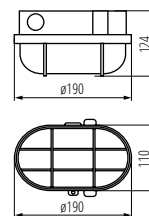

HERMI 7063NB

Kanlux MILO

HUBLOTS ► LAMPADA „TARTARUGA“



MILO 7040T/P-B



MILO 7040T/P-B | **08092** | 5905339080929 | max 60 | GLS\CFL\LED | E27 | noir | nero
 MILO 7040T | **70522** | 5905339705228 | max 60 | GLS\CFL\LED | E27 | gris | grigio
 MILO 7040T/P | **70523** | 5905339705235 | max 60 | GLS\CFL\LED | E27 | gris | grigio

[V] 220-240 AC	[Hz] 50	[mm] 1-1,5	IP 54	IK 06	UK CA
[mm] 1-1,5	[mm] 1-1,5	[mm] 0,5m	CE	ERC	UK CA



MILO 7040T



MILO 7040T/P



Kanlux MILO est un luminaire à canal classique qui est généralement utilisé dans les locaux techniques, les garages, les sous-sols, les cages d'escaliers, les couloirs, etc. Ce luminaire est doté d'un filet de protection en métal qui protège en outre le couvercle du luminaire contre les dommages mécaniques.

Matériau du boîtier: matériau plastique
 Matériau du diffuseur: verre

Kanlux MILO è una classica plafoniera di servizio utilizzata principalmente in locali di servizio, garage, scantinati, scale, corridoi ecc. L'apparecchio è dotato di una gabbia metallica (7040T) o plastica (7040T/P) di protezione che protegge ulteriormente il paralume della plafoniera da danni meccanici.

Materiale del corpo: plastica
 Diffusore: vetro

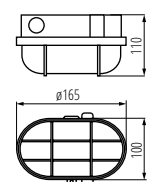

MILO 7040

Kanlux INES

HUBLOTS ► LAMPADA „TARTARUGA”



INES 7061N

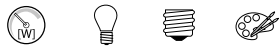

INES 7061N | 70525 | 5905339705259 max 100 GLS\CFL\LED E27 blanc | bianco

[V] 220-240 AC	[Hz] 50	[IP] 43	[W] max 100	[E27]	[Color] blanc bianco
[mm] 1	[m] 0,5m	[CE]	[EAC]	[UK CA]	[Recycle]

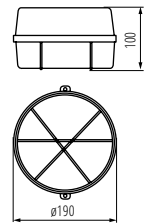

INES 7061N



Kanlux INES est un luminaire hermétique durable (IK08) avec une source de lumière remplaçable offrant une protection supplémentaire sous la forme d'un treillis métallique.

Matériau du boîtier: matériau plastique

Matériau du diffuseur: verre

Kanlux INES è una classica lampada "tartaruga" ermetica e resistente agli urti (IK08).

Materiale del corpo: plastica

Diffusore: vetro

Kanlux SANGA DL

PLAFONNIER À SOURCE LUMINEUSE REMPLAÇABLE ► PLAFONIERA CON LAMPADINA SOSTITUIBILE



SANGA DL-100



SANGA DL-100 | 08050 | 5905339080509 max 100 GLS\CFL\LED E27 blanc | bianco

[V] 220-240 AC	[Hz] 50	[IP] 44	[W] max 100	[E27]	[Color] blanc bianco
[mm] 1-1,5	[m] 0,5m	[CE]	[EAC]	[UK CA]	[Recycle]

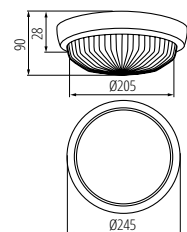

SANGA DL-100



Le plafonnier Kanlux SANGA est une solution économique pour les escaliers, les sous-sols, les greniers, les garages, mais aussi pour les terrasses et les balcons.

Matériau du boîtier: matériau plastique

Matériau du diffuseur: verre

La plafoniera Kanlux SANGA è una soluzione economica per scale, scantinati, soffitte, garage ma anche per terrazze e balconi.

Materiale del corpo: plastica

Diffusore: vetro

Kanlux TUNA

PLAFONNIER À SOURCE LUMINEUSE REMPLAÇABLE ► PLAFONIERA CON LAMPADINA SOSTITUIBILE



TUNA S1101-W



TUNA MINI N



Le plafonnier TUNA Kanlux est une solution pour les escaliers, les sous-sols, les greniers et autres pièces de ce type. Le degré approprié de protection contre la poussière et l'humidité permet l'utilisation du luminaire à l'intérieur et à l'extérieur des bâtiments.

Matériau du boîtier: matériau plastique

Matériau du diffuseur: verre

La plafoniera Kanlux TUNA è la soluzione studiata per scale, scantinati, soffitte e altri spazi di questo genere. L'apparecchio può essere utilizzato sia all'interno che all'esterno degli edifici grazie all'adeguato grado di protezione da polveri e umidità.

Materiale del corpo: plastica

Diffusore: vetro



TUNA S1101-W	04260	5905339042606	max 100	GLS\CFL\LED	E27	blanc bianco
TUNA MINI N	08091	5905339080912	max 100	GLS\CFL\LED	E27	blanc bianco

[V] 220-240 AC	[Hz] 50	□	IP 44	🏠	🔧	🔩
📏 1-1,5	📏 0,5m	🚫	CE	ERC	UK CA	🔄

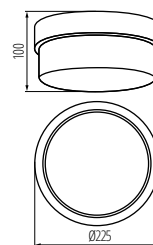

TUNA S1101

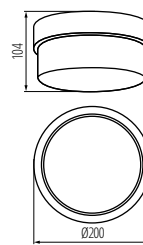

TUNA MINI

Kanlux TURK

PLAFONNIER À SOURCE LUMINEUSE REMPLAÇABLE ► PLAFONIERA CON LAMPADINA SOSTITUIBILE



TURK DL-60



Kanlux TURK est un plafonnier très résistant aux rayons UV. Il est idéal pour une utilisation en extérieur, par exemple sur la façade d'un bâtiment, d'une terrasse ou d'un balcon.

haute résistance au rayonnement UV (PIKTO)

haute résistance aux chocs

Matériau du boîtier: PC

Matériau du diffuseur: PC

Kanlux TURK è una plafoniera molto semplice. La sua elevata resistenza ai raggi UV la rende ideale per le condizioni d'utilizzo esterne, come ad esempio sulle facciate degli edifici, sulle terrazze o sui balconi.

elevata resistenza ai raggi UV

Materiale del corpo: PC

Diffusore: PC



TURK DL-60	07025	5905339070258	max 60	E27	blanc bianco
------------	-------	---------------	--------	-----	----------------

[V] 220-240 AC	[Hz] 50	□	IP 54	🏠	🔧	🔩
📏 1-2,5	📏 0,5m	🚫	CE	ERC	UK CA	🔄

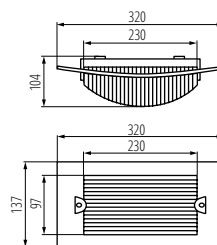

TURK DL-60

HIMA LED

LUMINAIRE DE TYPE DOWNLIGHT ► DOWNLIGHT



HIMA LED 23W-NW-W



HIMA LED 23W-NW-W



HIMA LED 23W-NW-B



HIMA LED 33W-NW-W



HIMA LED sont des downlights dits „escargots”, à haute efficacité lumineuse de plus de 100lm/W. La possibilité d'orienter ces appareils selon deux axes, combiné à un IRC de 90, rendent cet appareil idéal pour tout local d'exposition tel que boutique, surface de vente, galerie ou salon. La fiabilité de cet appareil est assurée par une garantie de 5 ans.

Une garantie de 5 ans accordée conformément aux termes de la déclaration de garantie disponible sur le site d'Internet

Matériau du boîtier: alliage en aluminium

Matériau du diffuseur: verre



I proiettori ad incasso Kanlux HIMA LED hanno un'altra efficienza luminosa (oltre 110 lm/W). Sono orientabili su due assi e hanno un elevato indice di resa cromatica rendendoli ideali per i luoghi in cui è importante valorizzare i colori, ad es: boutiques, stands o nei negozi dai grandi spazi. Essendo un apparecchio potente, Kanlux HIMA LED garantirà un'ottima illuminazione anche in ambienti dai soffitti alti. L'affidabilità di queste lampade è confermata da una garanzia di 5 anni.

5 anni di garanzia secondo le condizioni della dichiarazione di garanzia consultabile sul sito Internet

Materiale del corpo: alluminio

Diffusore: vetro

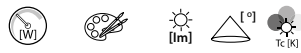

HIMA LED 23W-NW-W	22841	5905339228413	23	blanc bianco	2510	45	4000
HIMA LED 23W-NW-B	22842	5905339228420	23	noir nero	2510	45	4000
HIMA LED 33W-NW-W	22843	5905339228437	33	blanc bianco	3670	45	4000
HIMA LED 33W-NW-B	22844	5905339228444	33	noir nero	3670	45	4000

[V]	[Hz]	[lm]	[h]	[Ra]	[°]	[K]
220-240 AC	50	≥15000	30000	90	45	4000
IP 20	5+25	≤6x Macadam	45	COB	350	0,5-0,75
175 (mm)	0,5m	CE	ERC	CUK		

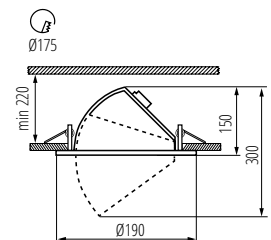

HIMA LED



TIBERI PRO

LUMINAIRE DE TYPE DOWNLIGHT ► DOWNLIGHT



TIBERI PRO 20W-940-W



TIBERI PRO 20W-940-B



TIBERI PRO 30W-940-W



TIBERI PRO 30W-940-B



TIBERI PRO 40W-940-W



TIBERI PRO 40W-940-B

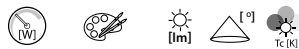

TIBERI PRO 20W-940-W	35670	5905339356703	20	blanc bianco	2100	90	4000
TIBERI PRO 20W-940-B	35671	5905339356710	20	noir nero	1900	90	4000
TIBERI PRO 30W-940-W	35672	5905339356727	30	blanc bianco	3150	90	4000
TIBERI PRO 30W-940-B	35673	5905339356734	30	noir nero	2850	90	4000
TIBERI PRO 40W-940-W	35674	5905339356741	40	blanc bianco	4200	90	4000
TIBERI PRO 40W-940-B	35675	5905339356758	40	noir nero	3800	90	4000

[V] 220-240 AC	[Hz] 50	[h] ≥30000	[h] 50000	[lm] ≤ 6k MacAdam	Ra 90	SMD	IP 44/20
	[°C] 5+25			CE	ERC	UK CA	

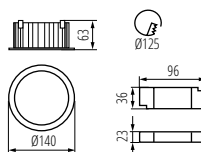

TIBERI PRO 20W

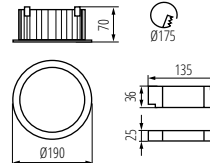

TIBERI PRO 30W

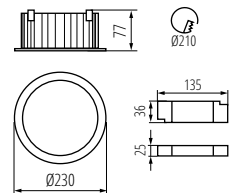

TIBERI PRO 40W



Kanlux TIBERI PRO sont des luminaires à encastrer dans le plafond. Ils sont adaptés pour les circulations, les espaces sanitaires ainsi que les bureaux et les espaces commerciaux. Les avantages de ces downlights : Durée de vie de 50 000 heures, l'indice de rendu de couleur élevé (IRC>90), efficacité lumineuse jusqu'à 105lm/W et garantie de 5 ans. L'étanchéité élevée IP44 les protège contre la poussière et l'humidité.

Une garantie de 5 ans accordée conformément aux termes de la déclaration de garantie disponible sur le site d'Internet

Matériau du boîtier: alliage en aluminium

Matériau du diffuseur: matériau plastique

I Kanlux TIBERI PRO sono faretti da incasso, si armonizzano perfettamente con i controsoffitti ed illumineranno corridoi, bagni, uffici e sono ideali per ambienti commerciali. I vantaggi di questi fari prevalentemente: 50.000 ore di durata, elevata indice di resa cromatica (CRI > 90), efficienza luminosa fino a 105lm/W e 5 anni di garanzia. Hanno un elevato grado di protezione (IP44 / 20) che li protegge da polvere, sporco e umidità.

5 anni di garanzia secondo le condizioni della dichiarazione di garanzia consultabile sul sito Internet

Materiali del corpo: alluminio

Diffusore: plastica

Kanlux

TIBERI PRO NT

LUMINAIRE DE TYPE DOWNLIGHT ► DOWNLIGHT



TIBERI PRO NT20W-940B



TIBERI PRO NT30W-940B



TIBERI PRO NT20W-940W



TIBERI PRO NT30W-940W

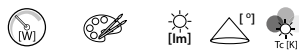

TIBERI PRO NT20W-940W	35676	5905339356765	20	blanc bianco	2200	115	4000
TIBERI PRO NT20W-940B	35677	5905339356772	20	noir nero	2200	115	4000
TIBERI PRO NT30W-940W	35678	5905339356789	30	blanc bianco	3000	115	4000
TIBERI PRO NT30W-940B	35679	5905339356796	30	noir nero	3000	115	4000

[V]	[Hz]	[h]	[h]	ellipse ≤ 6x MacAdam	Ra	SMD	CE	RoHS	IP
220-240 AC	50	≥30000	50000	90	90	SMD	CE	RoHS	54
[m]	[mm]	[m]	[m]						
0,18	0,75	0,5m							



Kanlux TIBERI PRO NT est une famille de downlights saillie. Ils sont disponibles en deux puissances (20W et 30W) et deux couleurs (blanc noir) tout en gardant la même taille. Le luminaire Kanlux TIBERI PRO se caractérise principalement par son étanchéité élevée (IP54) et son indice de rendu des couleurs élevé (Ra>90), mais aussi par son montage facile. Le luminaire Kanlux TIBERI PRO NT c'est des composants de haute qualité confirmés par une garantie de 5 ans.

Une garantie de 5 ans accordée conformément aux termes de la déclaration de garantie disponible sur le site d'Internet

Matériau du boîtier: alliage en aluminium

Matériau du diffuseur: matériau plastique

I faretto con montaggio a plafone Kanlux TIBERI PRO NT sono disponibili in due wattaggi (20W e 30W) e due colori (bianco e nero) pur mantenendo le stesse dimensioni. L'apparecchio Kanlux TIBERI PRO è caratterizzato principalmente da un'elevato grado IP (IP54) e da un'elevato indice di resa cromatica (Ra > 90), ma anche da una facile installazione a soffitto. L'elevata qualità del Kanlux TIBERI PRO NT è confermata da una garanzia di 5 anni.

5 anni di garanzia secondo le condizioni della dichiarazione di garanzia consultabile sul sito www.kanlux.com

Materiale del corpo: alluminio

Diffusore: plastica

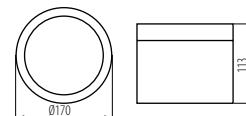

TIBERI PRO NT

AREL LED

LUMINAIRE DE TYPE DOWNLIGHT ► DOWNLIGHT



AREL LED D 14W

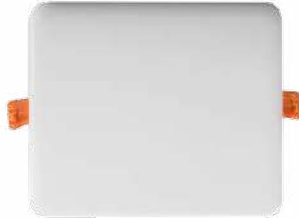

AREL LED DL 14W



AREL LED DO 6W



AREL LED DL 6W



AREL LED DO 10W

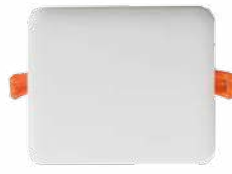

AREL LED DL 10W

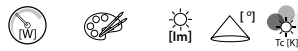

AREL LED DO 6W-NW	29580	5905339295804	6	blanc bianco	450	120	4000
AREL LED DO 6W-WW	29581	5905339295811	6	blanc bianco	440	120	3000
AREL LED DL 6W-NW	29582	5905339295828	6	blanc bianco	490	120	4000
AREL LED DO 10W-NW	29584	5905339295842	10	blanc bianco	940	120	4000
AREL LED DO 10W-WW	29585	5905339295859	10	blanc bianco	890	120	3000
AREL LED DL 10W-NW	29586	5905339295866	10	blanc bianco	1000	120	4000
AREL LED DO 14W-NW	29588	5905339295880	14	blanc bianco	1300	120	4000
AREL LED DO 14W-WW	29589	5905339295897	14	blanc bianco	1210	120	3000
AREL LED DL 14W-NW	29590	5905339295903	14	blanc bianco	1300	120	4000

[V] 220-240 AC	[Hz] 50	[h] ≥30000	[h] 15000	[lm] ≤6xNoctam	[lm] 80	[Ra] SMD	[lm] 360°	[lm] 0,75-1,5	[lm] 0,5m	[lm] 360°	[lm] CE	[lm] EAC	[lm] UK CA	[lm] IP 65/20	[lm] House
-------------------	------------	---------------	--------------	-------------------	------------	-------------	--------------	------------------	--------------	--------------	------------	-------------	---------------	------------------	---------------



IP 65/20

ultra SLIM panel

HIGH quality



Kanlux AREL LED est une nouvelle gamme de luminaires downlight sans cadre. Leur classe élevée d'étanchéité IP65/20 et un design unique, simple mais insolite, permettent à Kanlux AREL LED de bien s'intégrer dans chaque espace. Grâce à sa construction unique, le cadre a seulement 9 mm d'épaisseur: c'est le panneau le plus mince disponible sur le marché.

Matériau du boîtier: alliage en aluminium
Matériau du diffuseur: PMMA

Kanlux AREL LED è una nuova famiglia di faretti incasso ultrasottili e dal minimo ingombro. L'elevato grado di protezione IP65/20 e il design lineare e semplice ma allo stesso tempo sorprendente, permettono di abbinare Kanlux AREL LED a qualsiasi interno. Grazie alla sua costruzione unica, il faretto ha uno spessore di soli 9 mm, è il pannello più sottile disponibile sul mercato.

Materiale del corpo: alluminio
Diffusore: PMMA



AREL FRAME DO 14W W **33651** | 5905339336514 | blanc | bianco

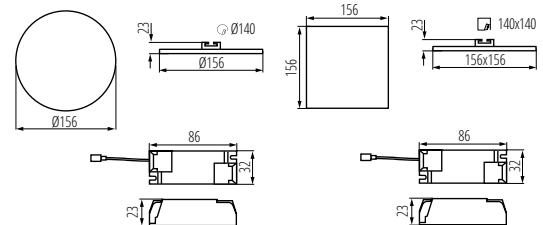

AREL LED DO 14W

AREL LED DL 14W

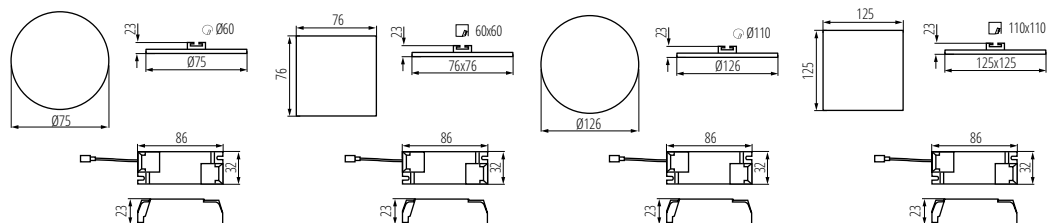

AREL LED DO 6W

AREL LED DL 6W

AREL LED DO 10W

AREL LED DL 10W

Kanlux

MATEO ES

LUMINAIRE DE TYPE DOWNLIGHT ► DOWNLIGHT



MATEO ES DLP-150-B



MATEO ES DLP-150-B	32930	5905339329301	max 25	noir nero
MATEO ES DLP-150-W	32931	5905339329318	max 25	blanc bianco
MATEO ES DLP-250-B	32932	5905339329325	2 x max 25	noir nero
MATEO ES DLP-250-W	32933	5905339329332	2 x max 25	blanc bianco

[V] 220-240 AC	[Hz] 50	ES-111	GU10	□	IP 20	⌚	⚡	✈	🔧
65/35	1,5	0,5m	CE	EMC	UK CA	⬇			



MATEO ES DLP-150-W



MATEO ES DLP-250-B



MATEO ES DLP-250-W

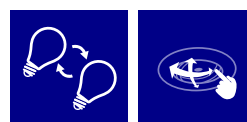

MATEO ES est un downlight carré à cardans destiné à être encastré et qui en étant équipé d'une source de type ES-111 de Kanlux. Le corps du luminaire est en tôle d'acier, peint en noir mat. Ce luminaire est disponible avec une collerette de finition blanche ou noire. Le luminaire est orientable.

Matériau du boîtier: alliage en aluminium

Kanlux MATEO ES è un elegante faretto incasso per lampade ES-111. Il corpo del faretto è in metallo verniciato in nero opaco. Il faretto è orientabile su due assi in tutte le direzioni.

Materiale del corpo: alluminio

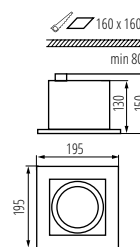

MATEO ES DLP-150

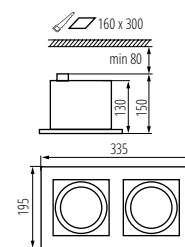

MATEO ES DLP-250

Kanlux

IVIAN LED

SPOT IP44 ► LAMPADA SPOT LED IP44



IVIAN LED 4,5W W



IVIAN LED 4,5W SN



MAN LED 4,5W W-WW	25780	5905339257802	4,5	blanc bianco	430	100	3000
MAN LED 4,5W SN-WW	25781	5905339257819	4,5	nickel satiné nichel satinato	410	100	3000
MAN LED 4,5W W-NW	25782	5905339257826	4,5	blanc bianco	480	100	4000
MAN LED 4,5W SN-NW	25783	5905339257833	4,5	nickel satiné nichel satinato	460	100	4000

[V] 220-240 AC	[Hz] 50	≥25000	15000	ellipse ≤ 6x Macadam	Ra 80	SMD	⊗	□	IP 44
⌚	⚡	✈	🔧	⊕	0,5m	CE	EMC	UK CA	⬇



Kanlux IVIAN LED est une gamme de luminaires de type downlight. Ils se caractérisent par un niveau d'étanchéité supérieur: IP44, ce qui permet de les installer dans les salles de bain et les pièces à humidité élevée. Les sources lumineuses sont des diodes LED SMD et le boîtier est conçu dans un matériau plastique de choix.

Matériau du boîtier: matériau plastique

Matériau du diffuseur: matériau plastique

Kanlux IVIAN LED è un faretto da incasso da 4,5W con un grado IP44. Realizzato in plastica è disponibile nel colore bianco o nickel satinato.

Materiale del corpo: plastica

Diffusore: plastica

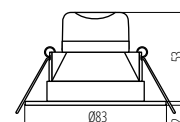

IVIAN LED 4-5W

TAVO LED

LUMINAIRE DE TYPE DOWNLIGHT ► DOWNLIGHT



TAVO LED DO 5W-NW



Kanlux TAVO LED est une gamme de downlights à encastrer. Ils sont disponibles en deux formes (ronde et carrée) et en 5 puissances (de 5 à 24 watts). Les downlights TAVO se caractérisent par un design scandinave minimaliste. Les avantages supplémentaires sont leur étanchéité IP44/20, ainsi que la possibilité de monter en saillie les modèles 12W et 18W dans le cadre TAVO FRAME de Kanlux.

Matériau du boîtier: matériau plastique
Matériau du diffuseur: matériau plastique

Kanlux TAVO LED rappresenta una nuova famiglia di faretti da incasso. Sono disponibili in due forme (tonda e quadrata) e ben 5 diverse potenze - da 5W a 24W. I Kanlux TAVO sono caratterizzati da un design minimalista e "nordico". Ulteriori vantaggi sono un grado IP44 / 20, nonché la possibilità di montaggio a superficie dei modelli 12W e 18W attraverso l'utilizzo delle apposite cornici Kanlux TAVO FRAME.

Materiale del corpo: plastica
Diffusore: plastica

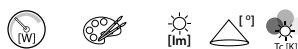

TAVO LED DO 5W-NW	36510	5905339365101	5	blanc bianco	400	120	4000
TAVO LED DO 9W-NW	36511	5905339365118	9	blanc bianco	900	120	4000
TAVO LED DO 12W-NW	36512	5905339365125	12	blanc bianco	1250	120	4000
TAVO LED DO 18W-NW	36513	5905339365132	18	blanc bianco	1900	120	4000
TAVO LED DO 24W-NW	36514	5905339365149	24	blanc bianco	2600	120	4000
TAVO LED DL 5W-NW	36515	5905339365156	5	blanc bianco	400	120	4000
TAVO LED DL 9W-NW	36516	5905339365163	9	blanc bianco	900	120	4000
TAVO LED DL 12W-NW	36517	5905339365170	12	blanc bianco	1250	120	4000
TAVO LED DL 18W-NW	36518	5905339365187	18	blanc bianco	1900	120	4000
TAVO LED DL 24W-NW	36519	5905339365194	24	blanc bianco	2600	120	4000

[V] 220-240 AC	[Hz] 50	≥15000	[h] 25000	diffuse ≤6xMaxdiam	Ra 80	SMD	IP 44/20
5+25	0,1	0,5m	CE	ERC	UK CA		

ACCESORIA ► ACCESSORIES

TAVO FRAME DO 12W	36520	5905339365200	Ramka do montażu natynkowego downlightów Kanlux TAVO LED.
TAVO FRAME DO 18W	36521	5905339365217	Ramka do montażu natynkowego downlightów Kanlux TAVO LED.
TAVO FRAME DL 12W	36522	5905339365224	Ramka do montażu natynkowego downlightów Kanlux TAVO LED.
TAVO FRAME DL 18W	36523	5905339365231	Ramka do montażu natynkowego downlightów Kanlux TAVO LED.



TAVO FRAME DO 12W



TAVO FRAME DO 18W



TAVO FRAME DL 12W



TAVO FRAME DL 18W

Kanlux

TAVO LED

LUMINAIRE DE TYPE DOWNLIGHT ► DOWNLIGHT



TAVO LED DO 5W-NW



TAVO LED DO 9W-NW



TAVO LED DO 12W-NW



TAVO LED DO 18W-NW



TAVO LED DO 24W-NW



TAVO LED DL 5W-NW



TAVO LED DL 9W-NW



TAVO LED DL 12W-NW



TAVO LED DL 18W-NW



TAVO LED DL 24W-NW

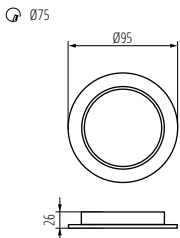

TAVO LED DO 5W-NW

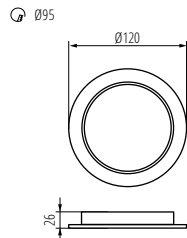

TAVO LED DO 9W-NW

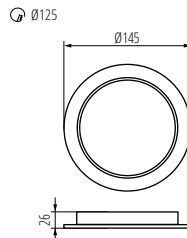

TAVO LED DO 12W-NW

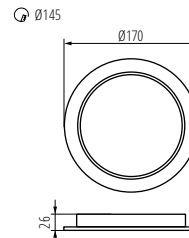

TAVO LED DO 18W-NW

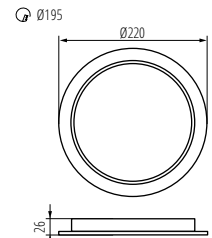

TAVO LED DO 24W-NW

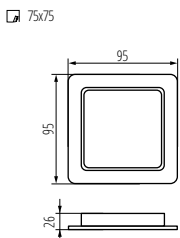

TAVO LED DL 5W-NW

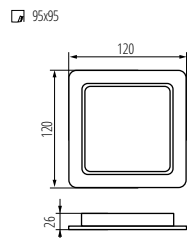

TAVO LED DL 9W-NW

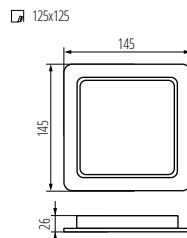

TAVO LED DL 12W-NW

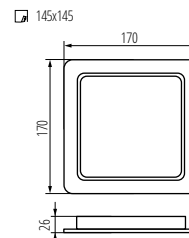

TAVO LED DL 18W-NW

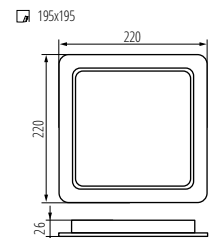

TAVO LED DL 24W-NW



ROUNDA V2LED

LUMINAIRE DE TYPE DOWNLIGHT ► DOWNLIGHT



ROUNDA V2LED18W-W

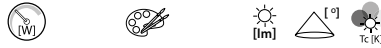

ROUNDA V2LED24W-NW-SN	27220	5905339272201	24	nickel satiné nichel satinato	1700	110	4000
ROUNDA V2LED6W-NW-SN	27221	5905339272218	6	nickel satiné nichel satinato	300	110	4000
ROUNDA V2LED12W-NW-SR	28930	5905339289308	12	argent argento	660	110	4000
ROUNDA V2LED12W-NW-W	28931	5905339289315	12	blanc bianco	780	110	4000
ROUNDA V2LED12W-WW-W	28932	5905339289322	12	blanc bianco	720	110	3000
ROUNDA V2LED18W-NW-SR	28933	5905339289339	18	argent argento	1080	110	4000
ROUNDA V2LED18W-NW-W	28934	5905339289346	18	blanc bianco	1260	110	4000
ROUNDA V2LED18W-WW-W	28935	5905339289353	18	blanc bianco	1200	110	3000
ROUNDA V2LED24W-NW-W	28936	5905339289360	24	blanc bianco	1680	110	4000
ROUNDA V2LED6W-NW-W	28937	5905339289377	6	blanc bianco	330	110	4000
ROUNDA V2LED6W-WW-W	28938	5905339289384	6	blanc bianco	300	110	3000
ROUNDA V2LED24W-WW-W	33524	5905339335241	24	blanc bianco	1560	110	3000
ROUNDA V2LED6W-WW-B	33562	5905339335623	6	noir nero	270	110	3000

[V] 220-240 AC	[Hz] 50	 ≥20000	[h] 15000	 ≤ 6W Max/Dim	 Ra 80	 SMD		 IP 44/20	
 5+25			[m] 0,05	[mm] 0,75	 0,5m	 360°			



Kanlux ROUNDA V2LED est une nouvelle version des downlights ronds populaires à usage interne. Ces downlights allient esthétique et lumière obtenue grâce à la technologie LED. Un degré élevé de protection IP44 empêche la pénétration d'eau et de poussière dans l'intérieur.

Matériau du boîtier: alliage en aluminium
Matériau du diffuseur: matériau plastique

Kanlux ROUNDA V2LED è la nuova versione dei famosi faretti rotondi di tipo downlight studiati per gli interni. Questi downlight uniscono il design estetico con la luce ottenuta grazie all'impiego della tecnologia LED. L'elevato grado di protezione IP44 impedisce all'acqua e alla polvere di penetrare all'interno.

Materiale del corpo: alluminio
Diffusore: plastica

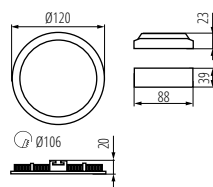

ROUNDA V2LED6W

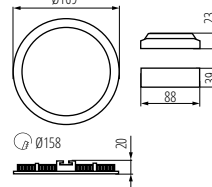

ROUNDA V2LED12W

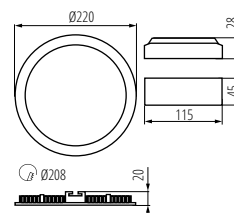

ROUNDA V2LED18W

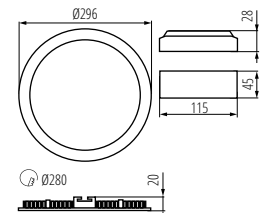

ROUNDA V2LED24W

Kanlux

RONDA V2LED

LUMINAIRE DE TYPE DOWNLIGHT ► DOWNLIGHT



RONDA V2LED6W-W



RONDA V2LED6W-SN



RONDA V2LED6W-SR



RONDA V2LED6W-B



RONDA V2LED12W-W



RONDA V2LED12W-SR



RONDA V2LED18W-W



RONDA V2LED18W-NW-SR



RONDA V2LED24W-W



RONDA V2LED24W-SN



KATRO V2LED

LUMINAIRE DE TYPE DOWNLIGHT ► DOWNLIGHT



KATRO V2LED 18W-W



KATRO V2LED 24W-NW-SN	27216	5905339272164	24	nickel satiné nichel satinato	1700	110	4000
KATRO V2LED 12W-NW-SR	28939	5905339289391	12	argent argento	660	110	4000
KATRO V2LED 12W-NW-W	28940	5905339289407	12	blanc bianco	780	110	4000
KATRO V2LED 12W-WW-W	28941	5905339289414	12	blanc bianco	720	110	3000
KATRO V2LED 18W-NW-SR	28942	5905339289421	18	argent argento	1080	110	4000
KATRO V2LED 18W-NW-W	28943	5905339289438	18	blanc bianco	1260	110	4000
KATRO V2LED 24W-NW-W	28945	5905339289452	24	blanc bianco	1680	110	4000
KATRO V2LED 6W-NW-W	28946	5905339289469	6	blanc bianco	330	110	4000

[V] 220-240 AC	[Hz] 50	[h] ≥20000	[h] 15000	[lm] ≤ 60 Macadam	Ra 80	SMD	[°] 360°	IP 44/20	°C 5±25
[mm] 0,05	[mm] 0,75	[mm] 0,5m	Φ _{use} 360°	CE	ERL	UKCA	↓		



Kanlux KATRO V2LED est une nouvelle version des luminaires KATRO N LED, downlights carrés très populaires à usage interne. Ils combinent un design esthétique à la lumière obtenue grâce à la technologie LED. Un degré élevé de protection IP44 empêche la pénétration d'eau et de poussière dans l'intérieur.

Matériau du boîtier: alliage en aluminium
Matériau du diffuseur: matériau plastique

Kanlux KATRO V2LED è una nuova versione del faretto KATRO N LED, famosi downlight a forma quadrata studiata per gli interni. L'elevato grado di protezione IP44 impedisce all'acqua e alla polvere di penetrare all'interno.

Materiale del corpo: alluminio
Diffusore: plastica

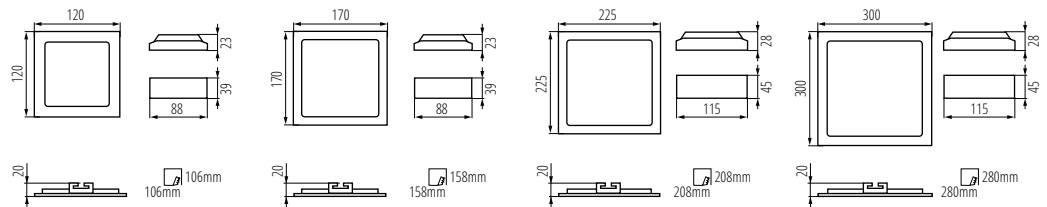

KATRO V2LED 6W

KATRO V2LED 12W

KATRO V2LED 18W

KATRO V2LED 24W

Kanlux

KATRO V2LED

LUMINAIRE DE TYPE DOWNLIGHT ► DOWNLIGHT



KATRO V2LED 6W-W



KATRO V2LED 12W-W



KATRO V2LED 12W-SR

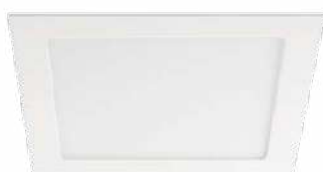

KATRO V2LED 18W-W



KATRO V2LED 18W-SR



KATRO V2LED 24W-W



KATRO V2LED 24W-SN



Kanlux

CARSA V2LED

LUMINAIRE DE TYPE DOWNLIGHT ► DOWNLIGHT



CARSA V2LED 24W-NW-W



Kanlux CARSA V2 LED est un luminaire circulaire caractérisé par une combinaison harmonieuse de la technologie LED avec un look attrayant et moderne. Il se distingue par son efficacité énergétique élevée tout en maintenant d'excellents paramètres d'éclairage. Kanlux CARSA V2 LED est idéal pour éclairer les intérieurs d'habitation ainsi que les bureaux.

Matériau du boîtier: alliage en aluminium
Matériau du diffuseur: matériau plastique

Kanlux CARSA V2 LED è una piccola plafoniera rotonda con montaggio a soffitto caratterizzata da un'armoniosa combinazione di tecnologia LED con design accattivante e moderno. Si distingue per l'efficienza energetica mantenendo al contempo eccellenti parametri di illuminazione. Kanlux CARSA V2 LED è ideale per l'illuminazione di interni residenziali e uffici.

Materiale del corpo: alluminio
Diffusore: plastica



CARSA V2LED 12W-NW-W



CARSA V2LED 18W-NW-W

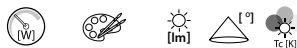

CARSA V2LED 12W-NW-W	28948	5905339289483	12	blanc bianco	780	110	4000
CARSA V2LED 18W-NW-W	28949	5905339289490	18	blanc bianco	1260	110	4000
CARSA V2LED 24W-NW-W	33541	5905339335418	24	blanc bianco	1680	110	4000

[V] 220-240 AC	[Hz] 50	≥20000	15000	diffuse ≤60°Maxbeam	Ra 80	SMD			IP 20	
5+25			0,05	0,75	0,5m	CE	ERC	UK CA		

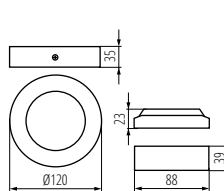

CARSA V2LED 12W

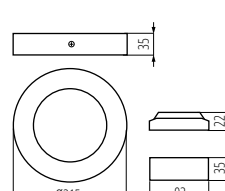

CARSA V2LED 18W

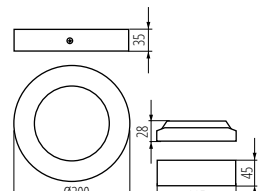

CARSA V2LED 24W

Kanlux

KANTI V2LED

LUMINAIRE DE TYPE DOWNLIGHT ► DOWNLIGHT



KANTI V2LED 18W-SN



KANTI V2LED 12W-W



KANTI V2LED 12W-SN



KANTI V2LED 18W-W



Kanlux KANTI V2 LED est un luminaire carré caractérisé par une combinaison harmonieuse de la technologie moderne avec un look attrayant et moderne. Il se distingue par son efficacité énergétique élevée tout en maintenant d'excellents paramètres d'éclairage. Kanlux KANTI V2 LED est idéal pour éclairer les intérieurs d'habitation ainsi que les bureaux.

Matériau du boîtier: alliage en aluminium
Matériau du diffuseur: matériau plastique

Kanlux KANTI V2 LED è una piccola plafoniera quadrata con montaggio a soffitto, disponibile nella versione da 12 o 18W. Si distingue per l'efficienza energetica mantenendo al contempo eccellenti parametri di illuminazione. Kanlux KANTI V2 LED è ideale per l'illuminazione di interni residenziali e uffici.

Materiale del corpo: alluminio
Diffusore: plastica



KANTI V2LED 12W-NW-SN	27212	5905339272126	12	nickel satiné nichel satinato	720	110	4000
KANTI V2LED 18W-NW-SN	27213	5905339272133	18	nickel satiné nichel satinato	1200	110	4000
KANTI V2LED 12W-NW-W	28950	5905339289506	12	blanc bianco	780	110	4000
KANTI V2LED 18W-NW-W	28951	5905339289513	18	blanc bianco	1260	110	4000

[V]	[Hz]	[h]	[h]	[lm]	[°]	[K]	[IP]	[°C]
220-240 AC	50	≥20000	15000	≤ 6x MacAdam	80	SMD	IP 20	5+25
[mm]	[mm]	[mm]	[mm]	[mm]	[mm]	[mm]	[mm]	[mm]
0,05	0,75	0,5m	360° Q _{use}	CE	EAC	UK CA		

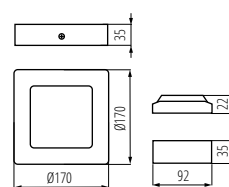

KANTI V2LED 12W

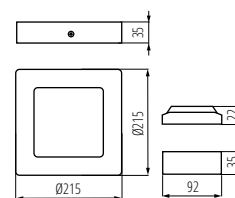

KANTI V2LED 18W

FL AGOR LED

PROJECTEUR LED ► PROIETTORE A LED



FL AGOR LED 100W NW



FL AGOR LED 150W NW



FL AGOR LED 200W NW



FL AGOR/A LED 100W NW



FL AGOR/A LED 150W NW



FL AGOR/A LED 200W NW



FL AGOR LED 100W NW	33470	5905339334701	100	12000	10800	4000	100	noir nero	E
FL AGOR LED 150W NW	33471	5905339334718	150	18000	15300	4000	100	noir nero	E
FL AGOR LED 200W NW	33472	5905339334725	200	24000	20300	4000	100	noir nero	E
FL AGOR/A LED 100W NW	33473	5905339334732	100	11000	9500	4000	X45\Y80	noir nero	F
FL AGOR/A LED 150W NW	33474	5905339334749	150	16500	12400	4000	X45\Y80	noir nero	E
FL AGOR/A LED 200W NW	33475	5905339334756	200	22000	17000	4000	X45\Y80	noir nero	E

[V] 220-240 AC	[Hz] 50	[W] ≥25000	[h] 50000	diptipe ≤6xNoctkam	Ra 80	SMD	⊕	IP 65	🏠	🌡️ -40+35
🔌	↻ 180	🔌	📏 1	📏 1m	⚡ Hg	CE	ERC	UK CA	♻️	

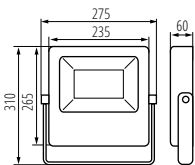

FL AGOR LED 100W
FL AGOR/A LED 100W

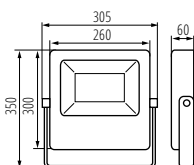

FL AGOR LED 150W
FL AGOR/A LED 150W

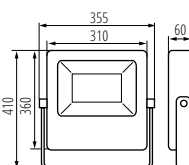

FL AGOR LED 200W
FL AGOR/A LED 200W



FL AGOR est une gamme de projecteurs produits sur des chaînes totalement automatisées, ce qui limite fortement tout risque d'erreur ou de malfaçon d'origine humaine. Des led de durée de vie 50 000h, combiné à une garantie de 5ans assurent un fonctionnement durable dans le temps et un maintien optimal des performances.

Une garantie de 5 ans accordée conformément aux termes de la déclaration de garantie disponible sur le site d'Internet

Matériau du boîtier: alliage en aluminium
Matériau vitre de protection: verre trempé

Kanlux AGOR LED è la serie di proiettori professionali ad alta potenza. Assemblati con componenti di alta qualità hanno una grado IP65. I proiettori Kanlux AGOR sono disponibili a distribuzione della luce simmetrica (AGOR) o asimmetrica (AGOR/A). Ideali per illuminare aree sportive o industriali, grandi cartelloni pubblicitari, magazzini e facciate di edifici. La durata e l'affidabilità dei proiettori Kanlux AGOR è sottolineata da una garanzia di 5 anni.

5 anni di garanzia secondo le condizioni della dichiarazione di garanzia consultabile sul sito www.kanlux.com

Materiale del corpo: alluminio
Vetro: vetro temperato

Kanlux

FL AGOR HI

PROJECTEUR LED ► PROIETTORE A LED



FL AGOR HI 240W NW



FL AGOR/A HI 240W NW



FL AGOR HI 300W NW



FL AGOR/A HI 300W NW



FL AGOR HI 240W NW	33476	5905339334763	240	36000	28800	4000	90	noir nero	D
FL AGOR/A HI 240W NW	33477	5905339334770	240	36000	28800	4000	X40°Y90	noir nero	D
FL AGOR HI 300W NW	33478	5905339334787	300	45000	36000	4000	90	noir nero	D
FL AGOR/A HI 300W NW	33479	5905339334794	300	45000	36000	4000	X40°Y90	noir nero	D

[V] 220-240 AC	[Hz] 50	120° Φ _{use}	≥50000	(h) 50000	(°C) ≤ 60/Max/Min	Ra 70	SMD		IP 65		°C -20+45
	° 180	IK 08	(mm) 0,28	(mm) 1	(m) 1m		CE	ERC	UK		

ACCESSORIA ► ACCESSORIES

FL AGOR HI GRID 240W	33482	5905339334824	Grille de protection pour projecteur FL AGOR HI 240W, FL AGOR HI GRID 240W, argent (33482) Griglia protettiva per proiettore FL AGOR HI 240W, FL AGOR HI GRID 240W, argento (33482)								
FL AGOR HI GRID 300W	33483	5905339334831	Grille de protection pour projecteur FL AGOR HI 300W, FL AGOR HI GRID 300W, argent (33483) Griglia protettiva per proiettore FL AGOR HI 300W, FL AGOR HI GRID 300W, argento (33483)								

WARRANTY
5 years

SUPER HIGH
lumen

up to

150 lm/W

FL AGOR HI „high” sont proposés en deux puissances élevées 240W et 300W, disponibles avec deux optiques symétriques et asymétriques, avec une garantie de 5ans, FL AGOR bénéficie d'une protection contre les surtensions (6kV), ainsi qu'une étanchéité IP65 et une résistance mécanique IK08 élevées. L'efficacité lumineuse de 150lm/W permet l'éclairage de grandes surfaces industrielles, commerciales et sportives.

Une garantie de 5 ans accordée conformément aux termes de la déclaration de garantie disponible sur le site d'Internet
Matériau du boîtier: alliage en aluminium
Matériau vitre de protection: verre trempé

I proiettori Kanlux AGOR HI hanno due potenze elevate: 240W e 300W. Questi proiettori sono disponibili in due versioni: FL AGOR HI (simmetrico), FL AGOR / A HI (asimmetrico) con una garanzia di 5 anni. Kanlux AGOR LED HI è un prodotto professionale, ha una protezione da sovratensione (6kV), un elevato grado di resistenza agli agenti atmosferici (IP 65) e ai danni meccanici (IK08) Un ulteriore vantaggio è l'altissima efficienza: fino a 150lm / W. Gli apparecchi sono progettati per illuminare grandi aree industriali, commerciali, sportive e ricreative. Opzionalmente è possibile dotarli di una griglia protettiva.

5 anni di garanzia secondo le condizioni della dichiarazione di garanzia consultabile sul sito Internet
Materiale del corpo: alluminio
Vetro: vetro temperato

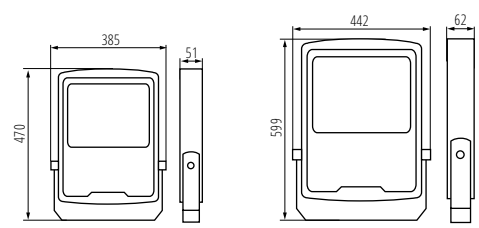

FL AGOR/A HI 240W

FL AGOR/A HI 300W

IQ-LED FL

PROJECTEUR LED ► PROIETTORE A LED



IQ-LED FL-30W-NW



5+
WARRANTY
5 years

up to
120 lm/W

DE
SIGN
unique

LED
technology

IQ LED FL est une gamme de projecteurs qualitative produit sur des chaines de production totalement automatisées, ce qui limite le risque de malfaçon d'origine humaine. Avec une efficacité de 120lm/W et une garantie de 5ans, IQ LED FL est la gamme la plus adéquate pour tout projet éclairage extérieur.

Une garantie de 5 ans accordée conformément aux termes de la déclaration de garantie disponible sur le site d'Internet

Matériau du boîtier: métal

Matériau du diffuseur: verre trempé

L'elevato standard di una produzione completamente automatizzata garantisce la ripetibilità dei parametri illuminotecnici. Questi ultimi includono LED di marca con una vita media di almeno 50.000 ore. L'insieme di queste caratteristiche ci permette di fornire una garanzia di 5 anni sull'intera serie di proiettori.

5 anni di garanzia secondo le condizioni della dichiarazione di garanzia consultabile sul sito www.kanlux.com

Materiale del corpo: metallo

Diffusore: vetro temperato



Model	Code	Part No.	Beam Angle	Power	Light Output	Beam Diameter	Color	Finish
IQ-LED FL-10W-NW	33880	5905339338808	10	1200	4000	65	noir nero	
IQ-LED FL-20W-NW	33881	5905339338815	20	2300	4000	65	noir nero	
IQ-LED FL-30W-NW	33882	5905339338822	30	3450	4000	65	noir nero	
IQ-LED FL-50W-NW	33883	5905339338839	50	6000	4000	65	noir nero	
IQ-LED FL-90W-NW	33884	5905339338846	90	10800	4000	65	noir nero	
IQ-LED FL-10W-NW-SE	33885	5905339338853	10	1200	4000	44	noir nero	PIR
IQ-LED FL-20W-NW-SE	33886	5905339338860	20	2300	4000	44	noir nero	PIR
IQ-LED FL-30W-NW-SE	33887	5905339338877	30	3450	4000	44	noir nero	PIR
IQ-LED FL-50W-NW-SE	33888	5905339338884	50	6000	4000	44	noir nero	PIR

[V]	[Hz]	[°]	[h]	[h]	[Ra]	[SMD]	[E]	[E]	[E]
220-240 AC	50	100	≥25000	50000	80	SMD			
[°C]	[mm]	[mm]	[mm]	[mm]	[mm]	[mm]	[mm]	[mm]	[mm]
-30+50	180	0,3	1	1m					
UK	CA								

ACCESSORIA ► ACCESSORIES

IQ-LED FL QC I 3x1MM2	33889	5905339338891	Presse-étoupe pour une connexion facile, rapide et sûre du câble de connexion et du projecteur, IQ-LED FL QC I 3x1MM2 (33889) Connettore rapido ermetico per un collegamento facile, rapido e sicuro del cavo di collegamento e del proiettore, IQ-LED FL QC I 3x1MM2 (33889)
-----------------------	-------	---------------	---

IQ-LED FL

PROJECTEUR LED ► PROIETTORE A LED



IQ-LED FL-10W-NW



IQ-LED FL-20W-NW



IQ-LED FL-30W-NW



IQ-LED FL-50W-NW



IQ-LED FL-90W-NW



IQ-LED FL-10W-NW-SE



IQ-LED FL-20W-NW-SE



IQ-LED FL-30W-NW-SE



IQ-LED FL-50W-NW-SE

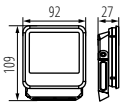

IQ-LED FL-10W-NW

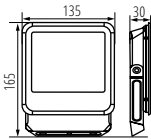

IQ-LED FL-20W-NW

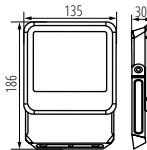

IQ-LED FL-30W-NW

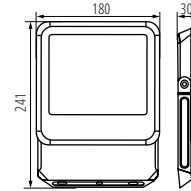

IQ-LED FL-50W-NW

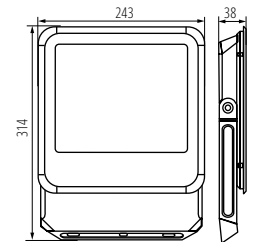

IQ-LED FL-90W-NW

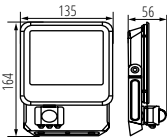

IQ-LED FL-10W-NW-SE

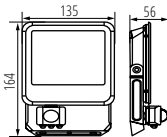

IQ-LED FL-20W-NW-SE

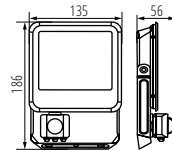

IQ-LED FL-30W-NW-SE

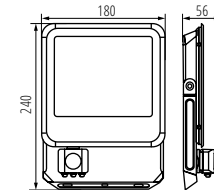

IQ-LED FL-50W-NW-SE



ANTEM LED

PROJECTEUR LED ► PROIETTORE A LED



ANTEM LED 10W-NW-SE B



ANTEM LED 20W-NW B



ANTEM LED 30W-NW B



ANTEM LED 50W-NW-SE B



Kanlux ANTEM est une gamme de projecteurs LED. Ces projecteurs sont avant tout faciles à raccorder grâce à leur boîte de jonction, vous pouvez ainsi éviter les connexions inesthétiques par câble. Kanlux ANTEM LED offre un large choix de puissance allant de 10 W à 100 W, ainsi que des versions avec et sans capteurs de mouvement. Un diffuseur opal à prismes disperse la lumière et réduit l'effet d'éblouissement. La version sans capteur de mouvement a indice d'étanchéité IP65, tandis que celui avec capteur a une étanchéité IP44. Le capteur peut être paramétré en fonction de la durée d'éclairage souhaitée, l'intensité lumineuse et la portée de détection.

Matériau du boîtier: alliage en aluminium
 Matériau vitre de protection: verre trempé
 Matériau du support: métal

Kanlux ANTEM è una serie di proiettori a LED per esterni. Sono molto facili da collegare, e grazie alla scatola di giunzione integrata si evita anche un antiestetico collegamento via cavo. Kanlux ANTEM LED offre una vasta gamma di opzioni: da 10W a 100W, nonché versioni con e senza sensori di movimento. Un paralume semiopaco con un delicato prisma disperde dolcemente la luce e riduce l'effetto abbagliante. La versione senza sensore di movimento ha un grado di tenuta IP65 e la versione con sensore IP44. Il sensore è tarabile per durata di accensione e sensibilità della luce circostante.

Materiale del corpo: alluminio
 Vetro: vetro temperato
 Materiale del braccio: metallo



Model	Power [W]	Beam angle [°]	Beam diameter [m]	Beam diameter [m]	Beam diameter [m]	Beam diameter [m]	Beam diameter [m]	Color	Material	Sensor
ANTEM LED 10W-NW B	33200	5905339332004	10	800	730	4000	65	noir nero	F	
ANTEM LED 20W-NW B	33201	5905339332011	20	1600	1510	4000	65	noir nero	F	
ANTEM LED 30W-NW B	33202	5905339332028	30	2400	2340	4000	65	noir nero	F	
ANTEM LED 50W-NW B	33203	5905339332035	50	4000	4000	4000	65	noir nero	F	
ANTEM LED 100W-NW B	33204	5905339332042	100	9500	8300	4000	65	noir nero	F	
ANTEM LED 10W-NW-SE B	33205	5905339332059	10	800	730	4000	44	noir nero	PIR	F
ANTEM LED 20W-NW-SE B	33206	5905339332066	20	1600	1510	4000	44	noir nero	PIR	F
ANTEM LED 30W-NW-SE B	33207	5905339332073	30	2400	2340	4000	44	noir nero	PIR	F
ANTEM LED 50W-NW-SE B	33208	5905339332080	50	4000	4000	4000	44	noir nero	PIR	F

[V] 220-240 AC	[Hz] 50	120° Φ _{use}	100	≥10000	15000	≤6 Macadam	80 Ra	SMD	IP44	PIR	House icon
Temp: -20+35	180	1-1,5	1m	CE	RoHS	UKCA	Recycling				

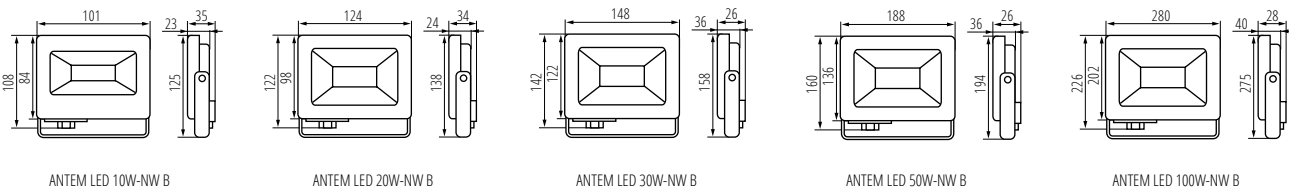
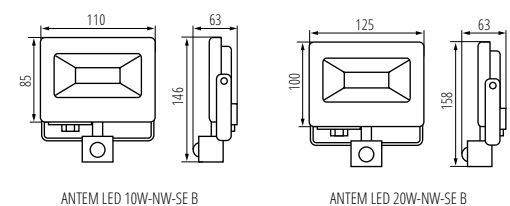
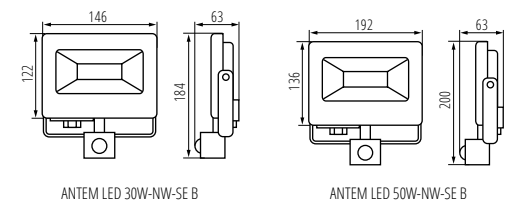

Kanlux STATO LED

PROJECTEUR LED ► PROIETTORE A LED



STATO N LED 30W-B



STATO N LED 30W-B



STATO N LED 50W-B

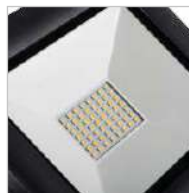

STATO LED est un projecteur portatif avec une étanchéité élevée IP65, recommandé sur les chantiers de construction et de rénovation. L'inclinaison du projecteur offre une souplesse d'utilisation, notamment grâce à son câble de longueur 2m doté d'une prise électrique.

Matériau du boîtier: alliage en aluminium
Matériau vitre de protection: verre trempé
Matériau du support: acier

Kanlux STATO LED è un proiettore portatile con elevato grado di protezione (IP65). È consigliato per illuminare cantieri, officine e dove serve una fonte di luce trasportabile. Orientabile, ha un indice di resa cromatica più elevato rispetto alla maggior parte dei proiettori (CRI≥80) il che si traduce in una possibilità di utilizzo all'interno (durante i lavori di ristrutturazione è possibile vedere meglio il colore della superficie illuminata). Kanlux STATO LED viene fornito con un cavo di 2 metri con spina.

Materiale del corpo: alluminio
Vetro: vetro temperato
Materiale del braccio: metallo

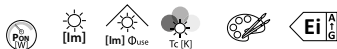

STATO N LED 30W-B	29222	5905339292223	30	3150	2770	4000	noir nero	F
STATO N LED 50W-B	29223	5905339292230	50	5250	4430	4000	noir nero	F

[V]	[Hz]	Φ_{use}	θ	≥ 15000	≤ 25000	ellipse $\leq 6x$ Macadam	Ra	SMD			IP	
220-240 AC	50	120°	120		25000		80				65	
°C		°	IK	[m]	[mm]	[m]			CE	ERL	UKA	
-20+35		330	07	2	1	1m						

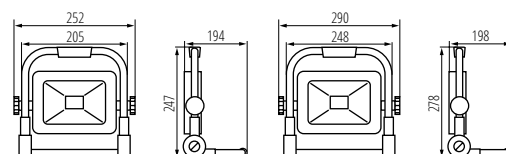

STATO N LED 30W-B

STATO N LED 50W-B

FL SONE SLR

LUMINAIRE SOLAIRE À LED ▶ LAMPADA SOLARE LED

NEW



FL SONE SLR M NW-GR



FL SONE SLR L NW-GR



FL SONE SLR

est un projecteur à énergie solaire, disponible selon deux versions : 10/100W ou 15/150W. Son étanchéité IP65 le rend étanche à la poussière et le protège contre les infiltrations d'eau. Les adaptateurs de fixation permettent d'installer séparément le luminaire et le panneau solaire.

Matériau du boîtier: ABS
Matériau du diffuseur: verre

Kanlux FL SONE e' un apparecchio alimentato dall'energia è solare . Possiamo scegliere fra due soluzioni: 10/100 watt o 15/150 watt. Il grado IP65 li rende a prova di agenti atmosferici protetti da infiltrazioni .e' possibile separare l'apparecchio dal pannello solare

Materiale del corpo: ABS
Diffusore: vetro



FL SONE SLR M NW-GR	36606	5905339366061	10\100	800	4000	65
FL SONE SLR L NW-GR	36607	5905339366078	15\150	1300	4000	65

[V] 3,2 DC		 90	 ≥20000	 25000	 ellipsoe ≤ 6x MacAdam	
	 -10+35					

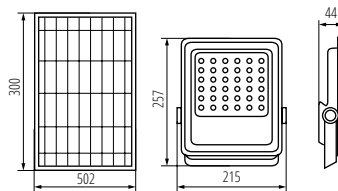

FL SONE SLR M NW-GR

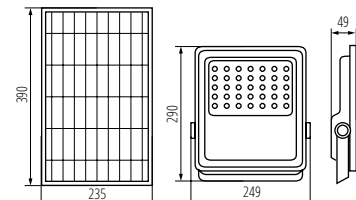

FL SONE SLR L NW-GR

FL SOLNAR SLR

LUMINAIRE SOLAIRE À LED ▶ LAMPADA SOLARE LED



FL SOLNAR SLR 8W NW-B

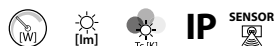

FL SOLNAR SLR 8W NW-B | 36605 | 5905339366054 | max 8 | max 800 | 4000 | 54 | PIR

IP 3,7 DC	≥15000	20000 h s (6x) / Max 1000h	80	SMD	
		-15+35	max 10	120	10-1
15-1000	max 100				

	15lx - 1000lx	
1 MODE	—	max 800 lm ☀️ 10s - 60s
2 MODE Night light	~40 lm	max 800 lm ☀️ 10s - 60s

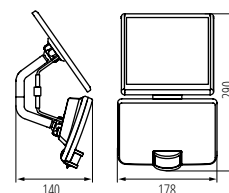

FL SOLNAR SLR 8W NW-B

Le luminaire Kanlux FL SOLNAR est un projecteur solaire. La puissance du projecteur est de 8W et son efficacité lumineuse est de 100lm/W (lorsque le luminaire est complètement chargé). L'indice de protection IP54 permet d'installer le projecteur dans des conditions poussiéreuses et humides sans crainte, ainsi qu'à l'extérieur dans des zones non couvertes. L'adaptateur réglable permet de monter séparément le luminaire et le panneau solaire. Le projecteur est équipé d'un détecteur de mouvement.

Un câble de rallonge de 2 m est fourni avec le luminaire pour permettre au panneau photovoltaïque d'être installé à une certaine distance du luminaire.

Matériau du boîtier: PC

Matériau du diffuseur: PC

L'apparecchio Kanlux FL SOLNAR è un proiettore solare. La potenza è di 8W e la sua efficacia luminosa è di 100lm / W (quando l'apparecchio è completamente carico). Il grado IP54 consente di montare facilmente il proiettore all'esterno così come in luoghi coperti. L'adattatore regolabile consente di montare separatamente l'apparecchio e il pannello solare. La lampada e' inoltre dotata di sensore di movimento.

Il proiettore viene fornito completo di un di cavo da 2mt che permette l'installazione del pannello fotovoltaico a distanza

Materiale del corpo: PC

Diffusore: PC



STRETON LED

LUMINAIRE LED POUR PARKING ► PROIETTORE STARDALE



STRETON LED 20W NW



STRETON LED 20W NW	36228	5905339362285	20	2800	4000	X140\Y90	gris grigio	D
STRETON LED 40W NW	36229	5905339362292	40	5600	4000	X140\Y90	gris grigio	D
STRETON LED 60W NW	36230	5905339362308	60	8400	4000	X140\Y90	gris grigio	D
STRETON LED 100W NW	36231	5905339362315	100	14000	4000	X140\Y90	gris grigio	D
STRETON LED 150W NW	36232	5905339362322	150	19500	4000	X140\Y90	gris grigio	E
STRETON LED 200W NW	36233	5905339362339	200	26000	4000	X140\Y90	gris grigio	E

[V] 220-240 AC	[Hz] 50	360° Φ _{use}	≥20000	50000	≤60 MacAdam	Ra 70
SMD		IP 65				
IK 08		0,4	1	1m		CE
ERC	UK CA					



Kanlux STRETON LED sont des luminaires extérieurs conçus pour éclairer des parkings ou des zones plus vastes qui doivent être éclairées même la nuit. Grâce à leur durée de vie (50 000 heures), leur étanchéité (IP65) et leur puissance élevée (jusqu'à 200W), les luminaires Kanlux STRETON LED sont adaptés aux espaces urbains, aux parkings, aux installations sportives ou places.

Une garantie de 5 ans accordée conformément aux termes de la déclaration de garantie disponible sur le site d'Internet

Matériau du boîtier: alliage en aluminium

Matériau vitre de protection: PC

I Kanlux STRETON LED sono proiettori stradali progettati per illuminare parcheggi o aree più grandi che devono essere ben illuminate anche dopo il tramonto. La loro durata (50.000 ore), elevato grado IP (65) ed elevata potenza (fino a 200W). Kanlux STRETON LED sono perfetti per realizzare progetti in spazi urbani, nei parcheggi, negli impianti sportivi, nelle piazze o nei parchi

5 anni di garanzia secondo le condizioni della dichiarazione di garanzia consultabile sul sito www.kanlux.com

Materiale del corpo: alluminio

Vetro: PC

STRETON LED

LUMINAIRE LED POUR PARKING ▶ PROIETTORE STARDALE



STRETON LED 20W NW



STRETON LED 40W NW



STRETON LED 60W NW



STRETON LED 100W NW



STRETON LED 150W NW



STRETON LED 200W NW

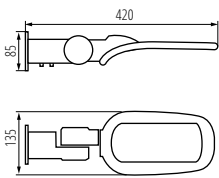

STRETON LED 20W NW

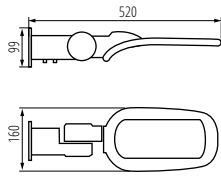

STRETON LED 40W NW

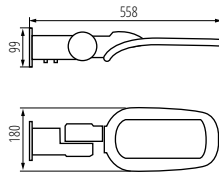

STRETON LED 60W NW

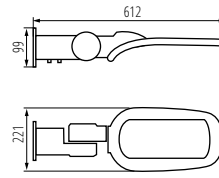

STRETON LED 100W NW

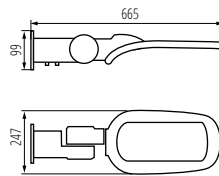

STRETON LED 150W NW

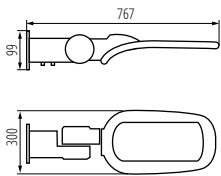

STRETON LED 200W NW



HB PRO LED HI

LUMINAIRE LED HIGH BAY ▶ LAMPADA LED HIGH BAY



HB PRO LED HI 100W-NW



HB PRO LED HI 150W-NW



HB PRO LED HI 200W-NW



HB PRO sont des armatures industrielles de type „High Bay“. Outre leur efficacité lumineuse 150lm/W, ces appareils se distinguent par leur robustesse et leur étanchéité élevée IP65. Le boîtier de jonction facilite le raccordement électrique.

Une garantie de 5 ans accordée conformément aux termes de la déclaration de garantie disponible sur le site d'Internet

Matériau du boîtier: alliage en aluminium

Matériau vitre de protection: matériau plastique

I proiettori Kanlux HB PRO LED sono progettati per massimizzare la dispersione della temperatura e assicurare un'elevata protezione (IP65). Hanno un sistema di connessione integrato che ne facilita il cablaggio ed un elevato rapporto di efficienza illuminotecnica pari a 150 lm/W.

5 anni di garanzia secondo le condizioni della dichiarazione di garanzia consultabile sul sito www.kanlux.com

Materiale del corpo: alluminio

Vetro: plastica



HB PRO LED HI 100W-NW	27155	5905339271556	100	14000	4000	noir nero
HB PRO LED HI 150W-NW	27156	5905339271563	150	21750	4000	noir nero
HB PRO LED HI 200W-NW	27157	5905339271570	200	28000	4000	noir nero

[V]	[Hz]	[°]	[h]	[h]	ellipse	Ra	SMD	IP
220-240 AC	50	90	≥15000	30000	≤6x MacAdam	80		65
			IK 08					
	-20+40			1m				

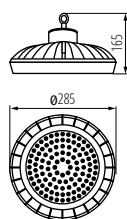

HB PRO LED HI 100W-NW

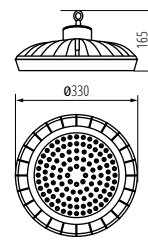

HB PRO LED HI 150W-NW

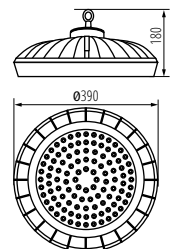

HB PRO LED HI 200W-NW

HB PRO LED HI

LUMINAIRE LED HIGH BAY ► LAMPADA LED HIGH BAY



HB PRO LED HI 200W



HBPH LENS 120D 100W



HBPH LENS 120D 150W



HBPH LENS 120D 200W



HBPH LENS 50D 100W



HBPH LENS 50D 150W



HBPH LENS 50D 200W



HBPH GRID 100W



HBPH GRID 150W



HBPH GRID 200W

AKCESORIA ► ACCESSORIES

HBPH LENS 120D 100W	33193	5905339331939	Lentille 120 degrés pour le luminaire HB PRO HI 100W, HBPH LENS 120D 100W (33193) Lente 120 gradi per apparecchio HB PRO HI 100W, HBPH LENS 120D 100W (33193)
HBPH LENS 120D 150W	33194	5905339331946	Lentille 120 degrés pour le luminaire HB PRO HI 150W, HBPH LENS 120D 150W (33194) Lente 120 gradi per apparecchio HB PRO HI 150W, HBPH LENS 120D 150W (33194)
HBPH LENS 120D 200W	33195	5905339331953	Lentille 120 degrés pour le luminaire HB PRO HI 200W, HBPH LENS 120D 200W (33195) Lente 120 gradi per apparecchio HB PRO HI 200W, HBPH LENS 120D 200W (33195)
HBPH LENS 50D 100W	33190	5905339331908	Lentille 50 degrés pour le luminaire HB PRO HI 100W, HBPH LENS 50D 100W (33190) Lente 50 gradi per apparecchio HB PRO HI 100W, HBPH LENS 50D 100W (33190)
HBPH LENS 50D 150W	33191	5905339331915	Lentille 50 degrés pour le luminaire HB PRO HI 150W, HBPH LENS 50D 150W (33191) Lente 50 gradi per apparecchio HB PRO HI 150W, HBPH LENS 50D 150W (33191)
HBPH LENS 50D 200W	33192	5905339331922	Lentille 50 degrés pour le luminaire HB PRO HI 200W, HBPH LENS 50D 200W (33192) Lente 50 gradi per apparecchio HB PRO HI 200W, HBPH LENS 50D 200W (33192)
HBPH GRID 100W	33196	5905339331960	Filet de protection pour le luminaire HB PRO LED HI 100W-NW, HBPH GRID 100W, argent (33196) Rete di protezione per apparecchio HB PRO LED HI 100W-NW, HBPH GRID 100W, argento (33196)
HBPH GRID 150W	33197	5905339331977	Filet de protection pour luminaire HB PRO LED HI 150W-NW, HBPH GRID 150W, argent (33197) Rete di protezione per apparecchio HB PRO LED HI 150W-NW, HBPH GRID 150W, argento (33197)
HBPH GRID 200W	33198	5905339331984	Filet de protection pour le luminaire HB PRO LED HI 200W-NW, HBPH GRID 200W, argent (33198) Rete di protezione per apparecchio HB PRO LED HI 200W-NW, HBPH GRID 200W, argento (33198)

REKA LED

LUMINAIRE POUR FAÇADE ► LAMPADA DA PARTE



REKA LED EL 7W-L-GR



REKA LED EL 7W-O-GR



REKA LED EL 7W-L-W



REKA LED EL 7W-O-W



Le principal avantage de Kanlux REKA LED est un effet lumineux visuel unique que vous pouvez créer vous-même après l'avoir allumé. Grâce aux ailes situées en haut et en bas du luminaire, la direction et la largeur du faisceau lumineux peuvent être décidées par l'utilisateur. La lampe Kanlux REKA brille dans deux directions - vers le haut et vers le bas - et le flux lumineux peut être réglé indépendamment l'un de l'autre en créant, par exemple, une ligne lumineuse parfaitement fine en haut, et en réglant en bas de larges cascades de lumière qui s'écouleront de la lampe jusqu'au sol. Kanlux REKA LED peut être utilisé pour éclairer les façades des bâtiments, les terrasses, les balcons ou les murs extérieurs des tonnelles.

Réglage de l'angle d'éclairage

Une garantie de 5 ans accordée conformément aux termes de la déclaration de garantie disponible sur le site d'Internet

Matériau du boîtier: alliage en aluminium

Matériau vitre de protection: verre trempé

Il vantaggio principale di Kanlux REKA LED è l'uso dei diodi LED che non perdono la loro luminosità nel tempo. L'effetto luce che la lampada crea all'accensione è visivamente interessante, così come una libera regolazione dell'angolo di luce emesso grazie alle alette orientabili. Kanlux REKA LED è una lampada da parete disponibile nel colore bianco o nero.

Regolazione dell'angolo di illuminazione

5 anni di garanzia secondo le condizioni della dichiarazione di garanzia consultabile sul sito www.kanlux.com

Materiale del corpo: alluminio

Vetro: vetro temperato

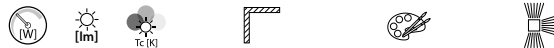

REKA LED EL 7W-L-GR	28990	5905339289902	7	max 360	4000	mural montaggio a parete	graphite grafite	haut et bas su e giù
REKA LED EL 7W-O-GR	28991	5905339289919	7	max 380	4000	mural montaggio a parete	graphite grafite	haut et bas su e giù
REKA LED EL 7W-L-W	28992	5905339289926	7	max 500	4000	mural montaggio a parete	blanc bianco	haut et bas su e giù
REKA LED EL 7W-O-W	28993	5905339289933	7	max 510	4000	mural montaggio a parete	blanc bianco	haut et bas su e giù

[V] 220-240 AC	[Hz] 50	[°] max 90	[lm] ≥20000	[h] 30000	[lm] ≤ 6x MacAdam	Ra 80	COB	[W] 5,3	[W] 41
IP 54	0,5m	[-15+35]	1	500	360°	5,3	41		
CE	ERC	UK CA							

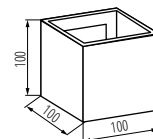

REKA LED EL-L

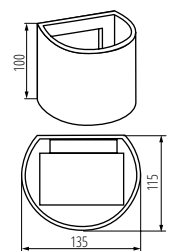

REKA LED EL 7W-O-W

Kanlux BISO LED

LUMINAIRE POUR FAÇADE ► LAMPADA DA PARTE



BISO LED EL 8W-GR



Kanlux FORRO sont des appliques d'extérieur qui se caractérisent par une conception simple et attrayante. Elles peuvent être utilisées comme luminaires d'intérieur (elles possèdent un IRC adéquat), mais elles peuvent également trouver une application sur les façades des immeubles (IP54). Dans le luminaire Kanlux BISO, la lumière du module LED est doucement dispersée sur la façade et la partie postérieure du luminaire.

Matériau du boîtier: alliage en aluminium

Matériau vitre de protection: matériau plastique

Kanlux FORRO sono apparecchi per facciate caratterizzati da un design semplice ed accattivante. Possono essere utilizzati come apparecchi di illuminazione per interni (hanno un indice CRI appropriato), ma allo stesso tempo possono essere utilizzati anche su facciate di edifici (IP54). Nell'apparecchio Kanlux BISO la luce proveniente dal modulo LED viene dolcemente diffusa sulla facciata e sulla parte posteriore dell'apparecchio.

Materiale del corpo: alluminio

Vetro: plastica

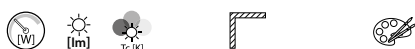

BISO LED EL 8W-GR	29260	5905339292605	8	140	4000	mural	montaggio a parete	graphite	grafite
BISO LED EL 8W-W	29261	5905339292612	8	375	4000	mural	montaggio a parete	blanc	bianco

[V]	[Hz]	[h]	[h]	[Ra]	[SMD]	[IP]
220-240 AC	50	≥25000	25000	80	COB	54
0,5m	-15+40	1,5+2,5	CE	ERAC	UK	

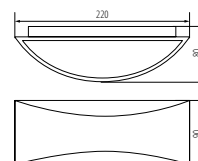

BISO LED EL 8W

Kanlux GARTO LED

LUMINAIRE POUR FAÇADE ► LAMPADA DA PARTE



GARTO LED EL 8W-GR



Kanlux GARTO sont des appliques d'extérieur qui se caractérisent par une conception simple et attrayante. Elles peuvent être utilisées comme luminaires d'intérieur (elles possèdent un IRC adéquat), mais elles peuvent également trouver une application sur les façades des immeubles (IP54). Dans le luminaire Kanlux GARTO, la lumière tombe sur la façade vers le haut et vers le bas, en étant dispersée dans les deux directions de manière uniforme.

Matériau du boîtier: alliage en aluminium

Matériau vitre de protection: matériau plastique

Kanlux GARTO sono apparecchi per facciate caratterizzati da un design semplice e accattivante. Possono essere utilizzati come apparecchi di illuminazione per interni (hanno un indice CRI appropriato), ma allo stesso tempo possono essere utilizzati anche su facciate di edifici (IP54). Nel caso di apparecchi Kanlux GARTO la luce illumina la facciata sia dall'alto che dall'basso e viene diffusa uniformemente in entrambe le direzioni.

Materiale del corpo: alluminio

Vetro: plastica

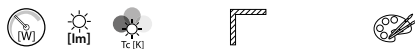

GARTO LED EL 8W-GR	29270	5905339292704	8	300	4000	mural	montaggio a parete	graphite	grafite
GARTO LED EL 8W-W	29271	5905339292711	8	350	4000	mural	montaggio a parete	blanc	bianco

[V]	[Hz]	[h]	[h]	[Ra]	[SMD]	[IP]
220-240 AC	50	≥25000	25000	80	SMD	54
0,5m	-15+40	1,5+2,5	CE	ERAC	UK	

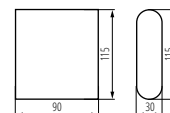

GARTO LED EL 8W

Kanlux ZEW EL

LUMINAIRE POUR FAÇADE ► LAMPADA DA PARTE



ZEW EL-235J-B



ZEW EL-235U-B



ZEW EL-235J-GR



ZEW EL-235U-GR



Les luminaires Kanlux ZEW sont parfaits pour l'éclairage des façades d'immeubles de tout style. Grâce au flux lumineux direct et indirect, ils créent des effets décoratifs sur les façade. Le degré d'étanchéité élevé IP44 permet d'installer ces luminaires dans des endroits exposés aux intempéries.

Matériau du boîtier: alliage en aluminium
Matériau vitre de protection: verre trempé

Le lampade da parete Kanlux ZEW sono ideali per illuminare facciate di edifici, balconi e terrazzi, e attraverso il flusso luminoso orientato sia verso l'altro che verso il basso, disegnano bellissimi e ornamentali accenti luminosi. L'elevato grado di protezione IP44 li rende adatti all'installazione in luoghi direttamente esposti agli agenti atmosferici.

Materiale del corpo: alluminio
Vetro: vetro temperato



Model	Code	Ref	Size	Socket	Mount	Color	Beam	Temp	Height	Depth
ZEW EL-235J-B	22440	5905339224408	2 x max 35	PAR16	GU10	mural montaggio a parete	noir nero	haut et bas	su e giù	
ZEW EL-235U-B	22441	5905339224415	2 x max 35	PAR16	GU10	mural montaggio a parete	noir nero	haut et bas	su e giù	
ZEW EL-235J-GR	22442	5905339224422	2 x max 35	PAR16	GU10	mural montaggio a parete	gris grigio	haut et bas	su e giù	
ZEW EL-235U-GR	22443	5905339224439	2 x max 35	PAR16	GU10	mural montaggio a parete	gris grigio	haut et bas	su e giù	

[V] 220-240 AC	[Hz] 50	Light bulb icon	Grounding icon	IP 44	0.5m	House icon
Temperature icon -20+35	Light bulb icon	Dimensions icon 1+2,5	CE	EMC	UKCA	Recycling icon

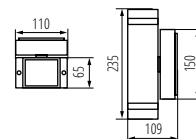

ZEW EL-235J

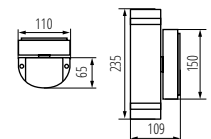

ZEW EL-235U

Kanlux

BART EL

LUMINAIRE POUR FAÇADE ► LAMPADA DA PARTE



BART EL-235



Kanlux BART EL est une applique murale qui s'intègre parfaitement à la façade d'un bâtiment moderne ou classique. Le degré d'étanchéité IP54 qui caractérise le luminaire Kanlux BART EL lui garantit une résistance élevée aux intempéries.

Matériau du boîtier: alliage en aluminium
Matériau vitre de protection: verre trempé

Lampada da parete up/down BART EL IP54 realizzata interamente in metallo e vetro.

Materiale del corpo: alluminio
Vetro: vetro temperato



BART EL-235 | **07080** | 5905339070807 | 2 x max 35 | PAR16 | GU10 | mural | montaggio a parete | gris | grigio | haut et bas | su e giù

[V] 220-240 AC	[Hz] 50			IP 54	 0,5m	
 -20+35		 1+2,5	CE	ERC	UK CA	

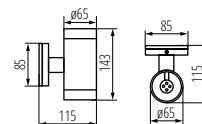

BART EL-235

Kanlux

LART EL

LUMINAIRE POUR FAÇADE ► LAMPADA DA PARTE



LART EL-160-GR



LART EL-260-GR



La gamme des appliques murales Kanlux LART offre des conceptions austères et classiques à la fois, dotées de boîtiers en aluminium. La surface externe du luminaire est recouverte de couleur anthracite. Les luminaires Kanlux LART sont très efficaces aussi bien séparément que dans une installation de plusieurs luminaires, en complétant délicatement les arrangements lumineux des terrasses ou des façades.

Matériau du boîtier: alliage en aluminium
Matériau vitre de protection: verre trempé

La serie di lampade da parete Kanlux LART è connotata da linee sobrie ma al contempo classiche. La superficie esterna in alluminio è rifinita in colore grigio grafite.

Materiale del corpo: alluminio
Vetro: vetro temperato

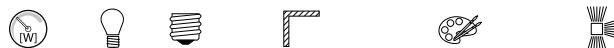

LART EL-160-GR | **29832** | 5905339298324 | max 60 | GLS\CFL\LED | E27 | mural | montaggio a parete | anthracite | antracite | bas | fondo
LART EL-260-GR | **29833** | 5905339298331 | 2x max 60 | GLS\CFL\LED | E27 | mural | montaggio a parete | anthracite | antracite | haut et bas | su e giù

[V] 220-240 AC	[Hz] 50			IP 54	 0,5m	
 -20+35		 0,5+1,5	CE	ERC	UK CA	

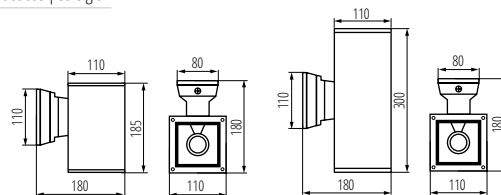

LART EL-160

LART EL-260

DULI LED

LUMINAIRE MURAL ► LAMPADA DA PARETE



DULI LED 4W-NW-L-GR



DULI LED est une gamme d'appliques murales saillies, directement alimentées sur le secteur 230V. Les formes géométriques classiques, la finition graphite mat et la température de couleur 4000°K font de ces appliques un modèle universel.

Matériau du boîtier: alliage en aluminium

Matériau vitre de protection: PC

Kanlux DULI LED è una nuova serie di lampade da parete. Il design moderno e geometrico conferisce a queste lampade un carattere universale e versatile. Hanno una finitura in grafite opaco ed una temperatura Kelvin pari a 4000K. Kanlux DULI LED funge da illuminazione decorativa con un carattere d'accento, illuminando e decorando gli spazi intorno all'edificio. Le lampade Kanlux DULI LED sono alimentate a 230V senza la necessità di ulteriori alimentatori.

Materiale del corpo: alluminio

Vetro: PC



DULI LED 4W-NW-O-GR



DULI LED 6,5W-NW-L-GR



DULI LED 6,5W-NW-O-GR

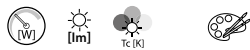

DULI LED 4W-NW-L-GR	33750	5905339337504	4	100	4000	anthracite antracite
DULI LED 4W-NW-O-GR	33751	5905339337511	4	100	4000	anthracite antracite
DULI LED 6,5W-NW-L-GR	33752	5905339337528	6,5	270	4000	anthracite antracite
DULI LED 6,5W-NW-O-GR	33753	5905339337535	6,5	270	4000	anthracite antracite

[V] 220-240 AC	[Hz] 50	 ≥25000	 30000	 Ra 80	 SMD
	 IP 54	 0,2m	 -15+35		
 0,75-1,5	 360° Φuse				

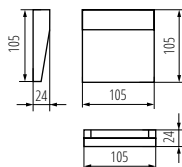

DULI LED 4W-NW-L-GR

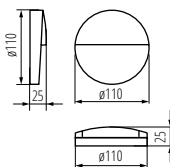

DULI LED 4W-NW-O-GR

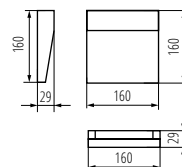

DULI LED 6,5W-NW-L-GR

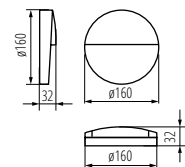

DULI LED 6,5W-NW-O-GR

Kanlux GLASI LED

LUMINAIRE ENCASTRABLE ► SEGNAPASSI



GLASI LED 3W P WW-W

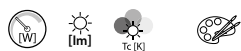

GLASI LED 3W P WW-W	33690	5905339336903	3	130	3000	blanc bianco
GLASI LED 3W P WW-B	33691	5905339336910	3	130	3000	noir nero
GLASI LED 3W P WW-GR	33692	5905339336927	3	130	3000	graphite grafite
GLASI LED 3W P NW-W	33693	5905339336934	3	140	4000	blanc bianco
GLASI LED 3W P NW-B	33694	5905339336941	3	140	4000	noir nero
GLASI LED 3W P NW-GR	33695	5905339336958	3	140	4000	graphite grafite

[V] 220-240 AC	[Hz] 50	[°] 120	[h] 15000	[h] 30000	[lm] ≤ 6x MacAdam	Ra 80	SMD	[W]	[lm]	[K]	[m]
IP 44	0,1m	10:35	96x61	CE	ERC	UK CA	[m]	[m]	[m]	[m]	[m]

Kanlux TAXI SMD

LUMINAIRE ENCASTRABLE ► SEGNAPASSI



TAXI SMD

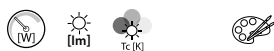

TAXI SMD L CVM-NW	26461	5905339264619	0,6	10	4000	chrome mat cromato opaco
TAXI SMD P CVM-NW	26463	5905339264633	0,6	10	4000	chrome mat cromato opaco

[V] 220-240 AC	[Hz] 50	[h] ≥10000	[h] 20000	[lm] ≤ 6x MacAdam	Ra 80	SMD	[W]	[lm]	[K]	[m]
IP 54	0,1m	-20:35	0,22	0,75	CE	ERC	UK CA	[m]	[m]	[m]



GLASI LED 3W P-GR



GLASI LED 3W P-B



GLASI LED est une gamme d'appareils pour éclairage mural de forme classique, déclinée en 3 couleurs (noir, graphite, blanc) destinée à éclairer les murs, façades et escaliers dans les locaux publics ou privés.

la boîte de jonction incluse
Matériau du boîtier: alliage en aluminium
Matériau vitre de protection: verre
Matériau du panneau/cadre: PC

Kanlux GLASI LED è una serie di segnapassi da parete. La forma semplice e tre colori dell'involucro (nero, grafite e bianco) rendono Kanlux GLASI LED perfetti per illuminare pareti, facciate di edifici e scale (sia in appartamenti che in luoghi pubblici) e conferiscono loro un carattere unico.

scatola da incasso inclusa
Materiale del corpo: alluminio
Vetro: vetro
Materiale del pannello/della cornice: PC

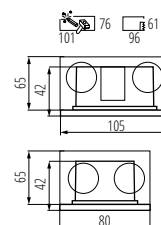

GLASI LED 3W P



Kanlux TAXI SMD est un luminaire d'accentuation à LED. Il peut être installé à l'intérieur et à l'extérieur des bâtiments (IP54). C'est une solution idéale pour l'éclairage décoratif des escaliers ou des paliers.

Matériau du boîtier: métal
Matériau vitre de protection: verre
Matériau du panneau/cadre: acier inoxydable

Kanlux TAXI SMD è un segnapassi ideale per esterni ed interni. Grado IP54. Disponibile con gradazione 3000K o 4000K. Quadrato o rettangolare.

Materiale del corpo: metallo
Vetro: vetro
Materiale del pannello/della cornice: acciaio inox



TAXI SMD P C/M

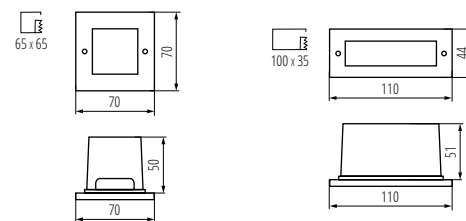

TAXI SMD L

TAXI SMD P

Kanlux

TURRO LED

LUMINAIRE ENCASTRE SOL ► PROIETTORE CARRABILE



TURRO LED 3X15W-NW



Kanlux TURRO LED est un robuste luminaire encastrable sol avec une source intégrée. Le luminaire est fabriqué avec des matériaux de la haute qualité et avec le souci du détail. Grâce à la haute protection IP67 et à la résistance aux chocs IK10, ce luminaire est adapté à l'éclairage des entrées, des allées, des trottoirs, etc. Kanlux TURRO c'est également un flux lumineux élevé, ce qui nous permet de l'utiliser dans les grands espaces.

Matériau du boîtier: alliage en aluminium

Matériau vitre de protection: verre trempé

Matériau du panneau/cadre: acier inoxydable

Kanlux TURRO LED è un robusto proiettore da incasso terra con lampada led integrata. L'apparecchio è realizzato con materiali di altissima qualità e curato in ogni dettaglio. Grazie all'elevato grado IP67 e ad un grado di resistenza ai danni meccanici IK10, questo apparecchio è perfetto per illuminare viali, vicoli, marciapiedi, facciate etc,etc. Kanlux TURRO LED è un proiettore potente ed affidabile.

Materiale del corpo: alluminio

Vetro: vetro temperato

Materiale del pannello/della cornice: acciaio inox



TURRO LED 3X15W-NW | 18983 | 5905339189837 | 45 | argent | argento | 3600 | 40 | 4000

[V] 220-240 AC	[Hz] 50	[h] ≥15000	[h] 30000	[lm] ≤60 Macadam	Ra 80	COB	⊕	IP 67	1m	🏠
[°C] -20+35	[kN] 20	IK 10	[m] 0,5	[mm] 1	lm W 80	CE	ERC	UK CA	🔄	

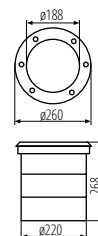

TURRO LED 3X15W-NW

Kanlux

GORDO N

LUMINAIRE ENCASTRE SOL ► PROIETTORE CARRABILE



GORDO N 1W CW-L-SR



GORDO N 1W CW-O-SR



Kanlux GORDO LED14 un luminaire à inertie avec une source lumineuse intégrée à LED, conçue pour être encastré dans le sol. Ce luminaire est fabriqué à partir de matériaux de la plus haute qualité, grâce à quoi il résiste à des pressions allant jusqu'à 2 tonnes et un degré de protection élevé IP67.

Matériau du boîtier: alliage en aluminium

Matériau verre de protection: verre trempé

Matériau du panneau/cadre: acier inoxydable

Kanlux GORDO N è un faretto incasso terra. È realizzato con materiali di altissima qualità che ne garantiscono una resistenza a pressioni fino a 20kN. Ha un elevato grado IP67

Materiale del corpo: alluminio

Vetro: vetro temperato

Materiale del pannello/della cornice: acciaio inox



GORDO N 1W CW-L-SR	18192	5905339181923	1	argent argento	50	80	6500
GORDO N 1W CW-O-SR	18193	5905339181930	1	argent argento	50	80	6500

[V]	[Hz]	⚡	⌚	⊕	Ra	⊖	⊗
220-240 AC	50	≥10000	20000	ellipse ≤ 6x MacAdam	80	SMD	⊗
⚡	IP	⚡	🏠	🌡️	[kN]	IK	🐍
	67	0,1m		-20+35	20	08	
[m]	[mm]	💡	lm	CE	EAC	UK	⚡
0,2	0,75		W			CA	
			50				

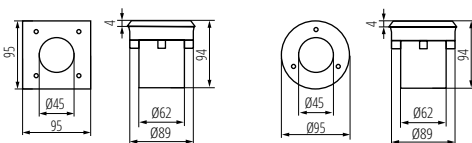

GORDO N 1W CW-L

GORDO N 1W CW-O

Kanlux

ROGER DL

LUMINAIRE ENCASTRE SOL ► FARETTO LED - LUCE RADANTE



ROGER DL-LED12



ROGER DL-2LED6



Kanlux ROGER DL est un luminaire à installer dans le sol avec un module LED intégré. La forme spécifique du globe répartit la lumière de manière uniforme, ce qui se traduit par un effet lumineux unique. Le luminaire se caractérise par un degré élevé de étanchéité IP66 et une résistance aux dommages mécaniques IK09.

la boîte de jonction incluse

Matériau du boîtier: acier

Matériau verre de protection: matériau plastique

Matériau du panneau/cadre: alliage en aluminium

Kanlux ROGER DL sono faretti incasso a luce radante competiti di un modulo LED integrato. Il proiettore è caratterizzato dall'elevato grado di protezione IP66 e la resistenza meccanica IK09.

scatola da incasso inclusa

Materiale del corpo: metallo

Vetro: plastica

Materiale del pannello/della cornice: alluminio

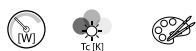

ROGER DL-LED12	07280	5905339072801	1	6000-6500	gris grigio
ROGER DL-2LED6	07281	5905339072818	1	6000-6500	gris grigio

[V]	[Hz]	⌚	⊗	⚡	IP	⚡	🏠	🌡️
220-240 AC	50	20000			66	0,1m		-20+35
⚡	IK	[m]	[mm]	💡	CE	EAC	UK	⚡
	09	0,3	0,75					

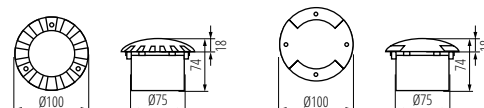

ROGER DL-LED12

ROGER DL-2LED6

Kanlux BERG AD

LUMINAIRE ENCASTRE SOL ► PROIETTORE CARRABILE



BERG AD-70



BERG AD est un encastré de sol destiné à recevoir une lampe de culot GU10. Caractérisé par un indice de protection élevé IP67 et IK 10, il est particulièrement robuste et est garanti 5ans.

Une garantie de 5 ans accordée conformément aux termes de la déclaration de garantie disponible sur le site d'Internet

Matériau du boîtier: alliage en aluminium, matériau plastique

Matériau vitre de protection: verre trempé

Matériau du panneau/cadre: acier inoxydable

Kanlux BERG AD è un faretto da incasso terra molto robusto e con lampada GU10 sostituibile. È perfetto per valorizzare vialetti, vicoli, giardini, terrazzi, ecc. Il modello AD offre una serie di nuovi vantaggi, quali: doppio pressacavo (possibilità di collegamento passante), fascio luminoso orientabile sia orizzontalmente (360°) che verticalmente (25°) elevato sgrado IP (67) e protezione agli urti molto elevata con un grado IK10. La qualità del proiettore Kanlux BERG AD è confermata da una garanzia di cinque anni.

5 anni di garanzia secondo le condizioni della dichiarazione di garanzia consultabile sul sito Internet

Materiale del corpo: alluminio, plastica

Vetro: vetro temperato

Materiale del pannello/della cornice: acciaio inox



BERG AD-70	36430	5905339364302	max 7	PAR16	GU10	acier inoxydable	acciaio inox
BERG AD-7L	36431	5905339364319	max 7	PAR16	GU10	acier inoxydable	acciaio inox

[V] 220-240 AC	[Hz] 50	Light bulb icon	LED icon	Grounding icon	IP 67	0,5m	House icon	Temperature icon -20+35	25°
[kN] 20	IK 10	Box icon	Wiring icon	Wiring icon	CE	ERC	UK CA	Down arrow icon	



BERG AD-70

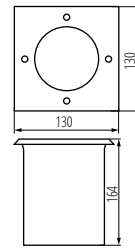

BERG AD-7L

Kanlux BERG DL

LUMINAIRE ENCASTRE SOL ► PROIETTORE CARRABILE



BERG DL-100



Kanlux BERG est un luminaire à installer dans le sol, durable avec source lumineuse remplaçable avec un culot GU10. C'est une solution idéale pour exposer les allées, les trottoirs, etc. Ce luminaire est fabriqué à partir de matériaux de la plus haute qualité, grâce à quoi il résiste à des pressions allant jusqu'à 500 kg.

la boîte de jonction incluse

possibilité de connexion des luminaires par câblage traversant

échange de la source de lumière plus facile

Matériau du boîtier: acier

Matériau vitre de protection: verre trempé

Matériau du panneau/cadre: acier inoxydable

Kanlux BERG è un faretto da incasso carrabile con una sorgente luminosa intercambiabile con attacco GU10. È ideale per illuminare vialetti, vicoli, marciapiedi ecc. È realizzato in materiali di altissima qualità che lo rendono resistente alla pressione fino a 500 kg.

scatola da incasso inclusa

collegamento passante per una facile connessione in serie senza raccordi esterni

facile sostituzione della lampada

Materiale del corpo: metallo

Vetro: vetro temperato

Materiale del pannello/della cornice: acciaio inox



BERG DL-100	07172	5905339071729	max 10	PAR16 LED	GU10	acier inoxydable	acciaio inox
BERG DL-10L	07173	5905339071736	max 10	PAR16 LED	GU10	acier inoxydable	acciaio inox

[V] 220-240 AC	[Hz] 50	Light bulb icon	LED icon	Grounding icon	IP 67	0,5m	House icon	Temperature icon -20+35
[kN] 5	IK 08	Box icon	Wiring icon	Wiring icon	CE	ERC	UK CA	Down arrow icon

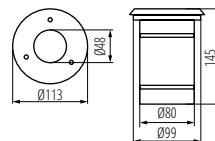

BERG DL-100

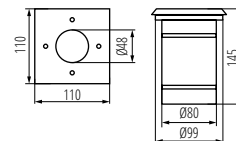

BERG DL-10L

Kanlux XARD DL

LUMINAIRE ENCASTRE SOL ► PROIETTORE CARRABILE



XARD DL-40



XARD DL-40 | 07195 | 5905339071958 max 40 A60 E27 acier inoxydable | acciaio inox

[V] 220-240 AC	[Hz] 50				IP 67	 0,5m	 -20+35		[kN] 20
IK 10		 0,22	 1						

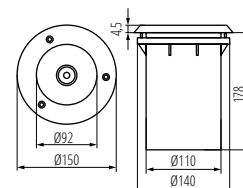

XARD DL-40



Le luminaire à installer dans le sol, Kanlux XARD, a le plus haut degré de résistance aux dommages mécaniques - ce qu'on appelle « anti-vandalisme » - IK10. Si l'on ajoute à cela un degré élevé d'étanchéité IP67, nous obtenons un luminaire qui constitue une excellente solution pour éclairer la façade de bâtiments, places, terrasses, parcs, chemins, passages, allées, escaliers, etc.

la boîte de jonction incluse

longueur totale de la source de lumière - max. 110 mm

Matériau du boîtier: alliage en aluminium

Matériau vitre de protection: verre trempé

Matériau du panneau/cadre: acier inoxydable

Kanlux XARD è un faretto incasso terra carrabile con attacco E27 ed un'elevata resistenza agli urti (IK10). Grado IP67. Controcassa in plastica inclusa.

scatola da incasso inclusa

lunghezza della lampadina max 110mm

Materiale del corpo: alluminio

Vetro: vetro temperato

Materiale del pannello/della cornice: acciaio inox

Kanlux MORO N

LUMINAIRE ENCASTRE SOL ► PROIETTORE CARRABILE



MORO N IG-20



MORO N IG-20 | 18194 | 5905339181947 max 20 PAR16 GU10 acier inoxydable | acciaio inox

[V] 220-240 AC	[Hz] 50				IP 67	 0,5m	 -20+35	[kN] 20	IK 08
	 3x1								

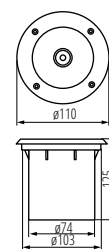

MORO N IG-20



Kanlux MORO DL est un luminaire à installer dans le sol, durable avec les sources lumineuses remplaçables avec un culot GU10, utilisé pour éclairer les allées, les voies, les trottoirs, etc. Fabriqué avec des matériaux de la plus haute qualité, il résiste à une pression de 20 kN. Le luminaire se caractérise par un degré élevé de d'étanchéité IP67 et une résistance aux dommages mécaniques IK08.

Matériau du boîtier: alliage en aluminium

Matériau vitre de protection: verre trempé

Matériau du panneau/cadre: acier inoxydable

Kanlux MORO N è un apparecchio da incasso terra con sorgente luminosa sostituibile ed attacco GU10 (max 20W). Puoi usarlo con per illuminare e vialetti, vicoli, marciapiedi o piante in giardino. È realizzato con materiali di altissima qualità, che ne garantiscono una resistenza a pressioni di 20kN. I suoi ulteriori vantaggi sono il grado IP67 e la resistenza IK08 ai danni meccanici.

Materiale del corpo: alluminio

Vetro: vetro temperato

Materiale del pannello/della cornice: acciaio inox



Kanlux

ABETE LED

LUMINAIRE EXTÉRIEUR LED ► PICCHETTO LED

NEW



ABETE LED 60 GR



ABETE LED 80 GR



ABETE LED EL 20 GR



ABETE LED EL 20 SE-GR



ABETE LED 60 GR	36570	5905339365705	7	540	4000	graphite grafite	sol a terra
ABETE LED 80 GR	36571	5905339365712	7	540	4000	graphite grafite	sol a terra
ABETE LED EL 20 GR	36572	5905339365729	7	540	4000	graphite grafite	mural montaggio a parete
ABETE LED EL 20 SE-GR	36573	5905339365736	7	540	4000	graphite grafite	mural montaggio a parete PIR

[V] 220-240 AC	[Hz] 50	≥15000	30000	ellipso ≤ 6x MacAdam	Ra 80	SMD
lm W 77	CE	EAC	UK CA	IP 44	-20+35	0,2m

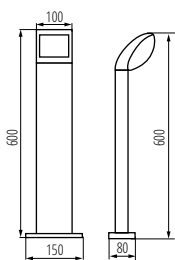

ABETE LED 60 GR

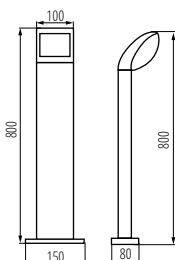

ABETE LED 80 GR

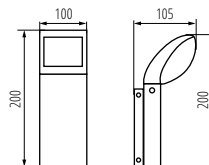

ABETE LED EL 20 GR

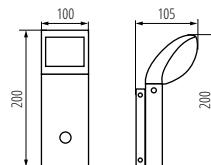

ABETE LED EL 20 SE-GR



Kanlux ABETE sont des luminaires d'extérieur pour ceux qui apprécient les classiques et la simplicité. Deux bornes de 60 et 80 cm de haut et deux appliques (dont une avec détecteur de mouvement - SE) offrent un design universel et fonctionnel. Le design élégant et fin permet l'utilisation des luminaires Kanlux ABETE de manière large et universelle aussi bien pour les jardins privés que pour les projets commerciaux.

Matériau du boîtier: alliage en aluminium
Matériau du diffuseur: matériau plastique

Gli apparecchi per esterni Kanlux ABETE sono consigliati a coloro che apprezzano lo stile classico e la semplicità. Due pali con un'altezza di 60 e 80 cm e due apparecchi a parete (di cui uno con sensore di movimento - SE) sono un design universale e funzionale. Il design elegante e sottile e il diffusore di luce in plastica lattiginosa consentono un uso ampio e universale degli apparecchi Kanlux ABETE sia in giardini privati che in progetti commerciali.

Materiale del corpo: alluminio
Diffusore: plastica

Kanlux PEVO

LUMINAIRE EXTÉRIEUR AVEC SOURCE DE LUMIÈRE REMPLAÇABLE
▶ LAMPADA DA GIARDINO CON LAMPADINA SOSTITUIBILE

NEW



PEVO 80 GR



PEVO 50 GR



PEVO EL 25 GR

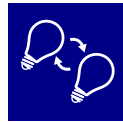

Kanlux PEVO est un éclairage extérieur de construction stable et robuste. Ces luminaires sont adaptés aux jardins à faible végétation. Ils ont été créés pour les zones de promenade, les avenues et les espaces verts à côté des immeubles d'habitation. Les bornes ainsi que l'applique murale Kanlux PEVO produisent un effet d'éclairage intéressant et discret. Les luminaires peuvent recevoir des sources lumineuses remplaçables avec culot GX53, ce qui confère au luminaire un caractère particulier et lui donne l'aspect d'une source lumineuse intégrée.

Matériau du boîtier: alliage en aluminium
Matériau du diffuseur: PC

Le Kanlux PEVO sono lampade ideali per giardini con vegetazione bassa. Sono state pensate per zone pedonali, vicoli e aree verdi adiacenti ai condomini. Sia i paletti che le lampade da parete Kanlux PEVO creano un effetto luminoso interessante e discreto. Gli apparecchi sono adattati a sorgenti luminose sostituibili con una attacco GX53.

Materiale del corpo: alluminio
Diffusore: PC



PEVO 80 GR	36550	5905339365507	max 11	LED	GX53	montage sol montaggio a parete/soffitto	graphite grafite
PEVO 50 GR	36551	5905339365514	max 11	LED	GX53	montage sol montaggio a parete/soffitto	graphite grafite
PEVO EL 25 GR	36552	5905339365521	max 11	LED	GX53	mural montaggio a parete	graphite grafite

[V] 220-240 AC	[Hz] 50				IP 44		 -20+35
	 1,5	 0,5m					

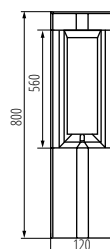

PEVO 80 GR

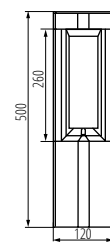

PEVO 50 GR

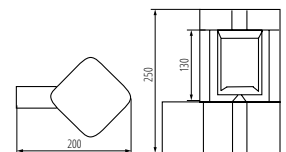

PEVO EL 25 GR

Kanlux

LAVEN

LUMINAIRE EXTÉRIEUR AVEC SOURCE DE LUMIÈRE REMPLAÇABLE
 ► LAMPADA DA GIARDINO CON LAMPADINA SOSTITUIBILE

NEW



LAVEN 80 GR



LAVEN 50 GR



LAVEN EL 28 SE-GR



LAVEN EL 25 GR



Kanlux LAVEN est un éclairage d'extérieur particulièrement élégant. Ces lampes de jardin ont un design unique basé sur un abat-jour fumé relié au reste du luminaire par une ligne diagonale. Leur style unique est mis en valeur par les sources lumineuses LED à filament - en particulier dans les couleurs chaudes. Collier à la base des poteaux Kanlux LAVEN facilite la fixation de la lampe dans le sol. Dans la famille de ces luminaires, il y a deux bornes : 50 et 80 cm, et deux appliques, dont l'une (SE) est équipée d'un détecteur de mouvement et de crépuscule intégré.

Matériau du boîtier: alliage en aluminium
 Matériau du diffuseur: PC

Le lampade da giardino Kanlux LAVEN sono eleganti e funzionali. Hanno un design unico basato su un diffusore fumé collegato in modo diagonale alla struttura della lampada. Il loro stile unico può essere enfatizzato dalle sorgenti luminose LED a filamento, specialmente in un colore caldo. La flangia alla base dei lampioncini Kanlux LAVEN facilita il fissaggio degli stessi al terreno. Nella famiglia di questi apparecchi ci sono due misure di lampadoni: 50 e 80 cm, e due applique, di cui una (SE) con sensore di movimento e crepuscolare integrato.

Materiale del corpo: alluminio
 Diffusore: PC



LAVEN 80 GR	36545	5905339365453	max 10	LED	E27	montage sol	montaggio a parete\soffitto	graphite	grafite
LAVEN 50 GR	36546	5905339365460	max 10	LED	E27	montage sol	montaggio a parete\soffitto	graphite	grafite
LAVEN EL 28 SE-GR	36547	5905339365477	max 10	LED	E27	mural	montaggio a parete	graphite	grafite PIR
LAVEN EL 25 GR	36548	5905339365484	max 10	LED	E27	mural	montaggio a parete	graphite	grafite

[V] 220-240 AC	[Hz] 50				IP 44		
			CE	ERC	UK	CA	

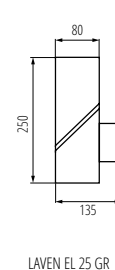
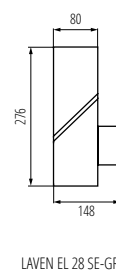
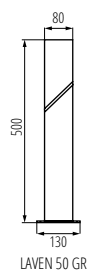
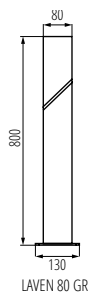

Kanlux PRESO

LUMINAIRE EXTÉRIEUR AVEC SOURCE DE LUMIÈRE REMPLAÇABLE
► LAMPADA DA GIARDINO CON LAMPADINA SOSTITUIBILE

NEW



PRESO 80 GR



PRESO 50 GR



PRESO 30 GR



PRESO EL 18 GR



PRESO 80 GR	36540	5905339365408	max 10	LED	E27	montage sol montaggio a parete/soffitto	graphite grafite
PRESO 50 GR	36541	5905339365415	max 10	LED	E27	montage sol montaggio a parete/soffitto	graphite grafite
PRESO 30 GR	36542	5905339365422	max 10	LED	E27	montage sol montaggio a parete/soffitto	graphite grafite
PRESO EL 18 GR	36543	5905339365439	max 10	LED	E27	mural montaggio a parete	graphite grafite

[V] 220-240 AC	[Hz] 50				IP 44		 -20+35
	 1,5	 0,5m	CE	EMC	UK CA		

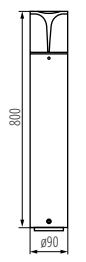

PRESO 80 GR



PRESO 50 GR

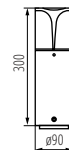

PRESO 30 GR

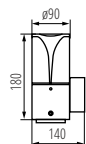

PRESO EL 18 GR



Kanlux PRESO est une famille de 4 luminaires de jardin, parmi lesquels on trouve trois bornes d'une hauteur allant de 30 à 80 cm, et leur complément idéal est une applique murale. Grâce à leur conception spéciale, les lampes éclairent latéralement plutôt que vers le haut, ce qui permet d'éclairer correctement les zones souhaitées. Le design profilé de l'abat-jour empêche l'eau de rester sur la surface de la lampe. Toute la gamme de lampes de jardin Kanlux PRESO convient aux sources lumineuses remplaçables E27, ce qui nous permet de choisir nous-mêmes l'intensité lumineuse et la couleur.

Matériau du boîtier: alliage en aluminium

Matériau du diffuseur: PC

Kanlux PRESO è una famiglia di 4 lampade da giardino, tra cui tre lampadine con altezze da 30 a 80 cm, e una lampada parete. Grazie allo speciale design, le lampade illuminano lateralmente invece che verso l'alto. Il design profilato del paralume impedisce all'acqua di rimanere sulla superficie della lampada. L'intera serie di apparecchi da giardino Kanlux PRESO è adattata a sorgenti luminose sostituibili con attacco E27 in modo da poter scegliere l'intensità e il colore della luce più appropriati.

Materiale del corpo: alluminio

Diffusore: PC

Kanlux

SELTO

LUMINAIRE EXTÉRIEUR AVEC SOURCE DE LUMIÈRE REMPLAÇABLE
 ► LAMPADA DA GIARDINO CON LAMPADINA SOSTITUIBILE

NEW



SELTO 80 B



SELTO 50 B



SELTO EL 23 B



Une forme simple et moderne intégrée dans le métal et le verre caractérise la famille de luminaires de jardin Kanlux SELTO. Grâce à sa forme, elle est adaptée aux jardins classiques ainsi qu'à ceux inspirés du style asiatique (référence à la forme de la pagode). La fonctionnalité supplémentaire de la colerette à la base permet une installation facile du luminaire. Les luminaires adaptés aux sources lumineuses E27.



Matériau du boîtier: acier inoxydable
 Matériau du diffuseur: verre

Le lamapde da giardino Kanlux SELTO hanno forme semplici e moderne collocate all'interno di una struttura in metallo e vetro. Grazie alle loro forme, sono perfette per i giardini classici così come quelli ispirati allo stile asiatico (simile a una pagoda), il supporto alla base consente un facile montaggio al terreno. Gli apparecchi sono adattati a sorgenti luminose con attacco E27.

Materiale del corpo: acciaio inox
 Diffusore: vetro



SELTO 80 B	36555	5905339365552	max 15	LED	E27	montage sol	montaggio a parete\soffitto	noir nero
SELTO 50 B	36556	5905339365569	max 15	LED	E27	montage sol	montaggio a parete\soffitto	noir nero
SELTO EL 23 B	36557	5905339365576	max 15	LED	E27	mural	montaggio a parete	noir nero

220-240 AC	50				IP 44	-20+35
1,5	0,5m					

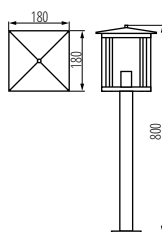

SELTO 80 B

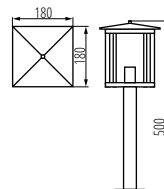

SELTO 50 B

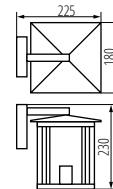

SELTO EL 23 B

Kanlux VIMO

LUMINAIRE EXTÉRIEUR AVEC SOURCE DE LUMIÈRE REMPLAÇABLE
▶ LAMPADA DA GIARDINO CON LAMPADINA SOSTITUIBILE



VIMO EL 27 SE-B



VIMO EL 27 BR; SE



VIMO 50 B; SE



VIMO 50 BR; SE



VIMO 80 B



VIMO 80 BR



Kanlux VIMO luminaires series is characterised by a unique shape bringing to mind lanterns. These garden lamps with a replaceable light source are available in two colours: matte black and bronze (copper). Kanlux VIMO consists of two sizes of posts and a wall lamp, including a version with a motion sensor. This unconventional shape and IP44 tightness class will make Kanlux VIMO lamps look great in every garden or house environment.

Matériau du boîtier: alliage en aluminium
Matériau du diffuseur: PC

La serie di lampade Kanlux VIMO è caratterizzata da una forma unica che porta pensare alle lanterne. Queste lampade da giardino con lampadina intercambiabile sono disponibili in due colori: nero opaco e bronzo (rame). Kanlux VIMO è disponibile di due misure e anche nella versione da parete, con o senza sensore di movimento. Le Kanlux VIMO hanno un grado IP44.

Materiale del corpo: alluminio
Diffusore: PC

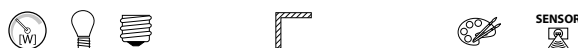

Model	Code	Part No.	Max H	Light	Base	Mounting	Color	Sensor
VIMO EL 27 B	34980	5905339349804	max 15	LED	E27	mural montaggio a parete	noir nero	
VIMO EL 27 BR	34981	5905339349811	max 15	LED	E27	mural montaggio a parete	brun marrone	
VIMO EL 27 SE-B	34982	5905339349828	max 15	LED	E27	mural montaggio a parete	noir nero	PIR
VIMO EL 27 SE-BR	34983	5905339349835	max 15	LED	E27	mural montaggio a parete	brun marrone	PIR
VIMO 50 B	34984	5905339349842	max 15	LED	E27	montage sol montage a parete/soffitto	noir nero	
VIMO 50 BR	34985	5905339349859	max 15	LED	E27	montage sol montage a parete/soffitto	brun marrone	
VIMO 50 SE-B	34986	5905339349866	max 15	LED	E27	montage sol montage a parete/soffitto	noir nero	PIR
VIMO 50 SE-BR	34987	5905339349873	max 15	LED	E27	montage sol montage a parete/soffitto	brun marrone	PIR
VIMO 80 B	34988	5905339349880	max 15	LED	E27	montage sol montage a parete/soffitto	noir nero	
VIMO 80 BR	34989	5905339349897	max 15	LED	E27	montage sol montage a parete/soffitto	brun marrone	

V	H	Light	Ground	IP	Temp
220-240 AC	50	LED	IP 44	-20+40	
1,5+2,5	0,5m	CE	UK		

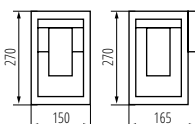

VIMO EL 27

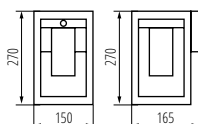

VIMO EL 27 SE

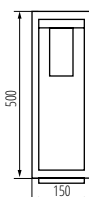

VIMO 50

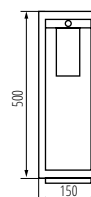

VIMO 50 SE

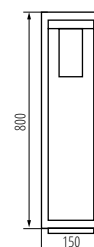

VIMO 80

Kanlux GORI

LUMINAIRE EXTÉRIEUR AVEC SOURCE DE LUMIÈRE REMPLAÇABLE
▶ LAMPADA DA GIARDINO CON LAMPADINA SOSTITUIBILE



GORI EL 235 D



GORI EL 235 D



GORI 50



GORI 80



GORI EL 135 D	29000	5905339290007	max 35	PAR16	GU10	bas fondo	anthracite antracite
GORI EL 235 D	29001	5905339290014	2 x max 35	PAR16	GU10	haut et bas su e giù	anthracite antracite
GORI 50	29002	5905339290021	max 35	PAR16	GU10	bas fondo	anthracite antracite
GORI 80	29003	5905339290038	max 35	PAR16	GU10	bas fondo	anthracite antracite

[V] 220-240 AC	[Hz] 50			IP 44		 -20/+35
	 1+2,5	 0,5m	CE	ERAC	UK CA	

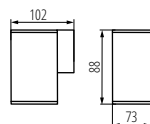

GORI EL 135

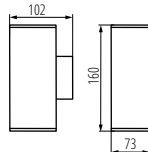

GORI EL 235

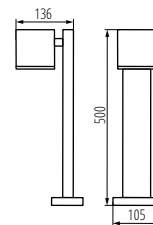

GORI 50

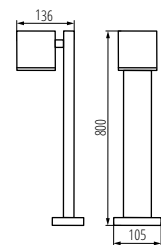

GORI 80

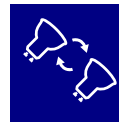

Les luminaires de jardin Kanlux GORI constituent une série complète de luminaires muraux et de potelets. Leur forme carrée et austère répond à la tendance du marché. Tous les luminaires Kanlux GORI sont équipés de sources lumineuses remplaçables, ce qui permet de choisir librement la couleur et l'intensité de la lumière.

Matériau du boîtier: alliage en aluminium
Matériau vitre de protection: verre trempé

Kanlux GORI è una serie completa, composta da lampade da parete e lampioni. La loro forma squadrata e minimalista è in sintonia con le tendenze del mercato. Tutti gli apparecchi di illuminazione Kanlux GORI sono dotati di sorgenti luminose sostituibili offrendo quindi la possibilità di scegliere liberamente il colore e l'intensità della luce intorno alla casa.

Materiale del corpo: alluminio
Vetro: vetro temperato

Kanlux

VADRA

LUMINAIRE EXTÉRIEUR AVEC SOURCE DE LUMIÈRE REMPLAÇABLE
 ► LAMPADA DA GIARDINO CON LAMPADINA SOSTITUIBILE



VADRA 21L-UP SE



VADRA 16L-UP



VADRA 50



VADRA 80



Les luminaires Kanlux VADRA d'extérieur sont conçus pour un montage mural (applique) ou au sol (potelet). Les luminaires VADRA sont équipés de sources lumineuses remplaçables, ce qui donne la possibilité de choisir librement la couleur et l'intensité de la lumière.

Hauteur maximale de la source lumineuse 110 mm

Matériau du boîtier: alliage en aluminium
 Matériau du diffuseur: matériau plastique

Gli apparecchi di illuminazione esterni Kanlux VADRA sono progettati per il montaggio a parete o a terra (lampioncini). I Kanlux VADRA sono dotati di attacchi E27 permettendo di scegliere la lampadine in base alle proprie esigenze.

La lampadina può avere un ingombro massimo di 110 mm

Materiale del corpo: alluminio
 Diffusore: plastica

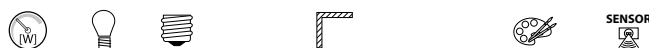

VADRA 16L-UP	29010	5905339290106	max 11	GLS\CFL\LED	E27	mural	montaggio a parete	anthracite	antracite	
VADRA 21L-UP SE	29011	5905339290113	max 11	GLS\CFL\LED	E27	mural	montaggio a parete	anthracite	antracite	PIR
VADRA 50	29012	5905339290120	max 11	GLS\CFL\LED	E27	montage sol	montaggio a parete\soffitto	anthracite	antracite	
VADRA 80	29013	5905339290137	max 11	GLS\CFL\LED	E27	montage sol	montaggio a parete\soffitto	anthracite	antracite	

[V] 220-240 AC	[Hz] 50			IP 44			
1,5+2,5			0,2m				

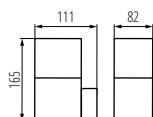

VADRA 16L

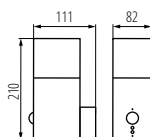

VADRA 21L

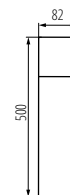

VADRA 50

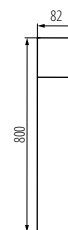

VADRA 80

INVO OP

LUMINAIRE ARCHITECTURAL AVEC SOURCE LUMINEUSE REMPLAÇABLE
 ► LAMPADA DA GIARDINO CON LAMPADINA SOSTITUIBILE



INVO OP 77-L-GR



INVO OP EL-53-L-GR



INVO OP 47-L-GR



INVO OP 77-L-GR



Kanlux INVO OP est une série de luminaires architecturaux externes. Toute la série comprend des poteaux et un luminaire de façade. Dans les luminaires Kanlux INVO, vous utiliserez votre couleur de lumière préférée, car elle est adaptée aux sources remplaçables avec un culot E27.

Diffuseur dépoli

Matériau du boîtier: matériau plastique

Matériau du diffuseur: matériau plastique

Kanlux INVO OP è una serie di lampade per esterni. Tutta la famiglia è composta da lampioncini e lampade da parete. Gli apparecchi d'illuminazione Kanlux INVO possono essere abbinati al vostro colore di luce preferito in quanto sono adatti a sorgenti luminose intercambiabili con attacco E27.

Il diffusore opalino

Materiale del corpo: plastica

Diffusore: plastica



INVO OP EL-53-L-GR	29170	5905339291707	max 20	GLS\CFL\LED	E27	mural montaggio a parete	graphite grafite
INVO OP 47-L-GR	29171	5905339291714	max 20	GLS\CFL\LED	E27	montage sol montaggio a parete\soffitto	graphite grafite
INVO OP 77-L-GR	29172	5905339291721	max 20	GLS\CFL\LED	E27	montage sol montaggio a parete\soffitto	graphite grafite
INVO OP 107-L-GR	29173	5905339291738	max 20	GLS\CFL\LED	E27	montage sol montaggio a parete\soffitto	graphite grafite

[V] 220-240 AC	[Hz] 50				IP 54		-20÷35
			0,75÷1,5	0,5m	CE	EMC	UKCA

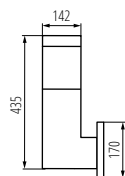

INVO OP EL-53

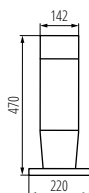

INVO OP 47

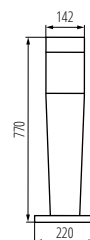

INVO OP 77

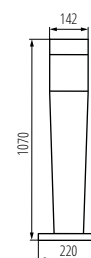

INVO OP 107

Kanlux

INVO TR

LUMINAIRE ARCHITECTURAL AVEC SOURCE LUMINEUSE REMPLAÇABLE
 ► LAMPADA DA GIARDINO CON LAMPADINA SOSTITUIBILE



INVO TR 77-O-GR



INVO TR EL-53-O-GR



INVO TR 47-O-GR



INVO TR 107-O-GR



Kanlux INVO TR est une série de luminaires architecturaux avec une source de lumière GU10 remplaçable. Les poteaux extérieurs et le luminaire de façade distribuent très efficacement la lumière non seulement dans le jardin, mais également dans les allées, les chemins ou les sentiers de promenade. Chaque luminaire peut accueillir 3 sources de lumière.

Diffuseur transparent

Matériau du boîtier: matériau plastique
 Matériau du diffuseur: matériau plastique

Kanlux INVO TR è una serie di lampade dotate di attacco GU10. La luce diffusa dei lampioni è molto d'effetto, consente di illuminare efficacemente non solo giardini, ma anche vialetti, sentieri e percorsi da passeggio. Ogni apparecchio dispone di uno spazio per 3 lampadine.

Diffusore in plastica trasparente
 Materiale del corpo: plastica
 Diffusore: plastica



INVO TR EL-53-O-GR	29174	5905339291745	3 x max 3,5	PAR16	GU10	mural	montaggio a parete	graphite	grafite
INVO TR 47-O-GR	29175	5905339291752	3 x max 3,5	PAR16	GU10	montage sol	montaggio a parete\soffitto	graphite	grafite
INVO TR 77-O-GR	29176	5905339291769	3 x max 3,5	PAR16	GU10	montage sol	montaggio a parete\soffitto	graphite	grafite
INVO TR 107-O-GR	29177	5905339291776	3 x max 3,5	PAR16	GU10	montage sol	montaggio a parete\soffitto	graphite	grafite

[V] 220-240 AC	[Hz] 50				IP 54		
	 0,75+2,5	 0,5m					°C -20+35

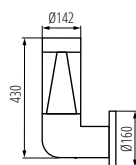

INVO TR EL-53

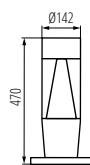

INVO TR 47

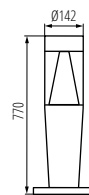

INVO TR 77

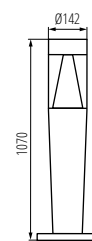

INVO TR 107

STONO N

LUMINAIRE EXTÉRIEUR AVEC SOURCE DE LUMIÈRE REMPLAÇABLE
 ► LAMPADA DA GIARDINO CON LAMPADINA SOSTITUIBILE



STONO 20 N



STONO 30

STONO 390 N

STONO 490 N



STONO 585 N

STONO 780 N



Les luminaires Kanlux STONO N sont un incontournable du jardin. Il s'agit de boules imitation pierre dont le diamètre varie de 31 à 78 cm. Ils s'intègrent parfaitement aux rocailles ou aux abords des buissons. Chaque modèle est équipé de piques qui permettent de fixer le luminaire dans le sol et d'un long câble d'alimentation (3 mètres). Kanlux STONO N sont des luminaires pour des sources lumineuses remplaçables.

câble 3 m dans le kit

Jeu de 4 piquets de fixation au sol inclus.

Matériau du boîtier: ABS

Matériau du diffuseur: LLDPE

Le lampade Kanlux STONO N sono un prodotto di indiscusso successo. Si tratta di sfere con diametri da 31 a 78 cm. Si adattano perfettamente ai giardini simulando il materiale roccioso. Ciascuna di esse è dotata di picchetti che consentono di fissare l'apparecchio nel terreno oltre che di un lungo cavo di alimentazione (3 metri). Le Kanlux STONO N utilizzano lampade led sostituibili.

cavo da 3m incluso

Materiale del corpo: ABS

Diffusore: LLDPE



Diamètre [mm]

Modèle	Code	SKU	max	Ø	Matériau	Base	Matériau
STONO 20 N	24654	5905339246547	max 15	200	GLS\CFL\LED	E27	granite granito
STONO 30	24651	5905339246516	max 25	300	GLS\CFL\LED	E27	granite granito
STONO 390 N	36591	5905339365910	max 20	390	GLS\CFL\LED	E27	granite granito
STONO 490 N	36592	5905339365927	max 20	490	GLS\CFL\LED	E27	granite granito
STONO 585 N	36593	5905339365934	max 20	585	GLS\CFL\LED	E27	granite granito
STONO 780 N	36594	5905339365941	max 20	780	GLS\CFL\LED	E27	granite granito

[VI] 220-240 AC	[Hz] 50			IP 65				
3	1	0,2m						

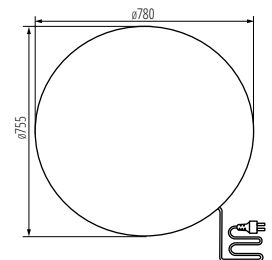

STONO 780 N

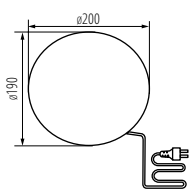

STONO 20 N

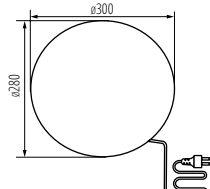

STONO 30

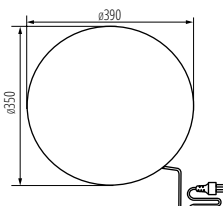

STONO 390 N

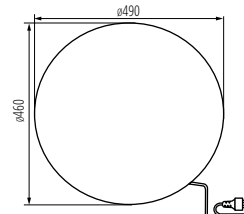

STONO 490 N

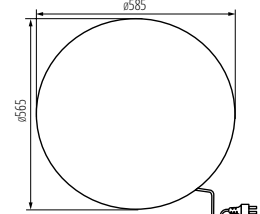

STONO 585 N



Kanlux

USTI SP

LUMINAIRE EXTÉRIEUR AVEC SOURCE DE LUMIÈRE REMPLAÇABLE
 ► LAMPADA DA GIARDINO CON LAMPADINA SOSTITUIBILE

NEW



USTI SP 2X7 GR



USTI SP 1X7 GR

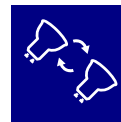

Kanlux USTI sont des luminaires parfaits pour l'éclairage directionnel de la verdure, des rocailles, des façades ou des éléments architecturaux intéressants que l'on souhaite mettre en valeur. La conception avec une tête mobile permet de régler librement et d'orienter la lumière dans la direction choisie. Il est possible de choisir un luminaire avec un ou deux points lumineux (les éléments lumineux peuvent être positionnés indépendamment les uns des autres). Les luminaires Kanlux USTI sont compatibles avec les sources GU10.

Matériau du boîtier: alliage en aluminium
 Matériau du diffuseur: verre

I faretto Kanlux USTI sono stati ideati per l'illuminazione direzionale del verde, di giardini rocciosi, facciate o elementi architettonici. La testa mobile permette di orientare la luce a piacere. Disponibili in due opzioni: apparecchi con uno o due punti luce (gli elementi luminosi possono essere regolati indipendentemente l'uno dall'altro). Sono compatibili con lampade con attacco GU10.

Materiale del corpo: alluminio
 Diffusore: vetro



USTI SP 2X7 GR	36560	5905339365606	2 x max 7	PAR16 LED	GU10	anthracite antracite
USTI SP 1X7 GR	36561	5905339365613	max 7	PAR16 LED	GU10	anthracite antracite

[V] 220-240 AC	[Hz] 50	[W] 10W	[m] 0,5m	IP 54	[°C] -20+35	[m] 0,5m
[m] 0,5-1	[m] 6-7,5	[m] 0,5m	CE	EAC	UK	[m] 0,5m

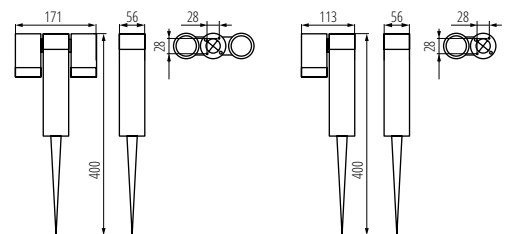

USTI SP 2X7 GR

USTI SP 1X7 GR

Kanlux VORA

LUMINAIRE EXTÉRIEUR AVEC SOURCE DE LUMIÈRE REMPLAÇABLE
▶ LAMPADA DA GIARDINO CON LAMPADINA SOSTITUIBILE

NEW



VORA SP 20 GR

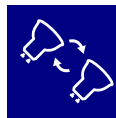

VORA est un luminaire extérieur destiné à recevoir une ampoule de culot GU10. Fixé au sol grâce à un piquet, il est facilement orientable dans l'espace, avec notamment sa visière pour éviter la dispersion du flux lumineux.

Matériau du boîtier: alliage en aluminium

Matériau vitre de protection: PC



Kanlux VORA è un apparecchio per esterni con una sorgente luminosa sostituibile (attacco GU10). La sua natura portatile (montata nel terreno con un picchetto) consente di modificare la disposizione dell'illuminazione della luce. Lavorazione solida ed esteticamente gradevole, aspetto esclusivo, design moderno e una testa con una flangia che limita la dispersione della luce sono solo alcuni dei suoi vantaggi.

Materiale del corpo: alluminio

Vetro: PC



VORA SP 20 GR	36565	5905339365651	max 7	PAR16 LED	GU10	graphite grafite
VORA EL 20 GR	36566	5905339365668	max 7	PAR16 LED	GU10	graphite grafite

[V] 220-240 AC	[Hz] 50				IP 44		 -20+35
		CE	EAC	UK CA			

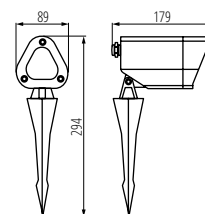

VORA SP 20 GR

Kanlux

GRIBLO 7 GR

LUMINAIRE EXTÉRIEUR AVEC SOURCE DE LUMIÈRE REMPLAÇABLE
► LAMPADA DA GIARDINO CON LAMPADINA SOSTITUIBILE

NEW



GRIBLO 7 GR



GRIBLO 7 GR | 36432 | 5905339364326 max 7 PAR16 LED GU10 anthracite | antracite

[V] 220-240 AC	[Hz] 50				IP 65		 -20+35		 180
	[m] 1		0,5m	CE	ERAC	UK CA			



GRIBLO 7 GR, destiné à l'éclairage de sujets faibles hauteurs comme les arbustes, les rocailles ou des petites petites architectures de jardin. Kanlux GRIBLO 7 GR est un des rares luminaires sur le marché à être équipé d'un câble d'alimentation muni d'une fiche, ce qui renforce son coté pratique.

Matériau du boîtier: alliage en aluminium
Matériau du diffuseur: verre

Kanlux GRIBLO 7 GR è il nuovo faretto orientabile da giardino con attacco GU10. È dotato di un picchetto metallico e di un cavo che termina con una spina ed è quindi molto comodo e facile da installare. Grado IP 65.

Materiale del corpo: alluminio

Diffusore: vetro

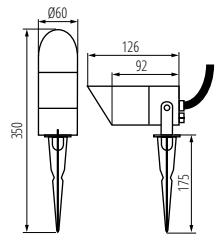

GRIBLO 7 GR

Kanlux

AKVEN LED

LUMINAIRE EXTÉRIEUR AVEC SOURCE DE LUMIÈRE REMPLAÇABLE ► LAMPADA DA GIARDINO CON LAMPADINA SOSTITUIBILE



AKVEN LED



AKVEN LED | 25720 | 5905339257208 max 35 MR16 Gx5,3 vert | verde

[V] 12 AC; 12 DC	[Hz] 50			 300	 120	 ≥15000	 25000	 3000	 ≤6°/MacAdam	 80		
IP 68		 -20+35		 180	 1-1,5	 0,5m	CE	ERAC	UK CA			



GRIBLO 7 GR, destiné à l'éclairage de sujets faibles hauteurs comme les arbustes, les rocailles ou des petites petites architectures de jardin. Kanlux GRIBLO 7 GR est un des rares luminaires sur le marché à être équipé d'un câble d'alimentation muni d'une fiche, ce qui renforce son coté pratique.

Matériau du boîtier: alliage en aluminium

Kanlux AKVEN LED è la soluzione perfetta per l'illuminazione di laghetti da giardino. Si tratta di un piccolo faretto led sommersibile fino a 3 metri di profondità. Funziona a 12 Volts ed è realizzato in metallo e vetro.

Materiale del corpo: alluminio

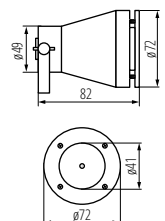

AKVEN LED



GRL 6M5E27-B



GRL 6M5E27-B



GRL 11M10E27-B



GRL 15M15E27-B



GRL 6M5E27-B	35750	5905339357502	5 x max 10	LED	E27	noir nero
GRL 11M10E27-B	35754	5905339357540	10 x max 10	LED	E27	noir nero
GRL 15M15E27-B	35758	5905339357588	15 x max 10	LED	E27	noir nero



La guirlande lumineuse Kanlux GRL est un moyen d'organiser rapidement l'éclairage à l'intérieur et à l'extérieur de la maison. Vous avez le choix entre trois longueurs de guirlande : 5, 11 et 15 mètres. Grâce à l'alimentation traversante, vous pouvez connecter plusieurs guirlandes ensemble et créer une installation jusqu'à 150 mètres de long. Pour la guirlande, nous recommandons les sources lumineuses LED Kanlux ST45 de 0,5W. Les guirlandes GRL se distinguent par leur câble de 1,5 mm², sûr et de bonne qualité.

La cordoniera di luci Kanlux GRL permette di illuminare con grande facilità gli ambienti all'interno e all'esterno della casa. Disponibile in tre lunghezze tra cui scegliere: 5, 11 e 15 metri. Grazie all'alimentatore passante, puoi collegare più ghirlande tra loro e creare una linea continua lunga fino a 150 metri. Per le ghirlande, consigliamo le sorgenti luminose Kanlux ST45 LED 0,5W. Le ghirlande Kanlux GRL si distinguono per il cavo da 1,5 mm² di alta qualità e sicurezza.

[V]	[Hz]	[W]	[L]	[IP]	[H]
220-240 AC	50			IP 44	
[°C]	[mm ²]	[CE]	[EAC]	[UKCA]	[Down Arrow]
-20+40	1,5				

AKCESORIA ► ACCESSORIES

ST45 LED 0,5W E27-NW	26046	5905339260468	A light source dedicated to Kanlux GRL string lights, (26046)
ST45 LED 0,5W E27-WW	26045	5905339260451	A light source dedicated to Kanlux GRL string lights, (26045)
ST45 LED 0,9W E27-BL	26039	5905339260390	Źródło światła dedykowane do girland Kanlux GRL, (26039)
ST45 LED 0,9W E27-GR	26048	5905339260482	Źródło światła dedykowane do girland Kanlux GRL, (26048)
ST45 LED 0,9W E27-RE	26049	5905339260499	Źródło światła dedykowane do girland Kanlux GRL, (26049)

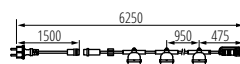

GRL 6M5E27-B

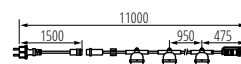

GRL 11M10E27-B

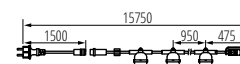

GRL 15M15E27-B

Kanlux DASTO



NEW



DASTO 250C FR B

IP



DASTO 250C FR B | 36585 | 5905339365859 | 44 | anthracite | antracite

[V] 220-240 AC	In[A] 16		 1,5			
 -20+35	CE	ERC	UK CA			



IP
44



Poteaux de raccordement Kanlux DASTO / NASTO avec prises de courant de type français. Grâce à leur sobriété, ils s'intègrent dans tous les types de jardins. Vous pouvez y raccorder un arroseur, une tondeuse à gazon, un barbecue électrique, des guirlandes lumineuses pour un arbre de Noël en plein air ou tout autre éclairage portable dont vous avez besoin.

Matériau: acier inoxydable

Colonnine di collegamento Kanlux DASTO / NASTO con prese di tipo francese. Grazie alla loro estetica semplice, possono essere integrati in qualsiasi tipo di giardino. Puoi collegare a loro un irrigatore, un tosaerba, una griglia elettrica, una ghirlanda luminosa, luci invernali per un albero di Natale all'aperto o qualsiasi altra illuminazione portatile di cui hai bisogno.

Materiale: acciaio inox

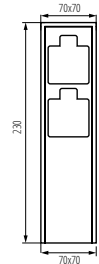

DASTO 250C FR B

Kanlux NASTO



NEW



NASTO 250C FR B

IP



NASTO 250C FR B | 36586 | 5905339365866 | 44 | anthracite | antracite

[V] 220-240 AC	In[A] 16		 1,5			
 -20+35	CE	ERC	UK CA			



IP
44



Poteaux de raccordement Kanlux DASTO / NASTO avec prises de courant de type français. Grâce à leur sobriété, ils s'intègrent dans tous les types de jardins. Vous pouvez y raccorder un arroseur, une tondeuse à gazon, un barbecue électrique, des guirlandes lumineuses pour un arbre de Noël en plein air ou tout autre éclairage portable dont vous avez besoin.

Matériau: acier inoxydable

Colonnine di collegamento Kanlux DASTO / NASTO con prese di tipo francese. Grazie alla loro estetica semplice, possono essere integrati in qualsiasi tipo di giardino. Puoi collegare a loro un irrigatore, un tosaerba, una griglia elettrica, una ghirlanda luminosa, luci invernali per un albero di Natale all'aperto o qualsiasi altra illuminazione portatile di cui hai bisogno.

Materiale: acciaio inox

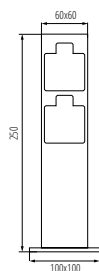

NASTO 250C FR B



ACORD ATL1

PROJECTEUR POUR MONTAGE SUR RAIL ► PROIETTORE PER BINARIO



ATL1 30W



ATL1 18W



Kanlux ACORD ATL1 sont des luminaires prévus pour un montage sur rails triphasés et qui peuvent s'adapter aux besoins spécifiques. Il est possible de choisir entre une finition en blanc ou en noir, deux puissances électriques (20W et 30W), la température de couleur et l'angle de diffusion de la lumière (en standard 60°, mais il est possible d'opter pour un réflecteur pour un angle de diffusion de 15° ou 36°) selon que vous souhaitez éclairer une surface générale ou souligner un détail particulier. Kanlux ACORD ATL1 a une durée de vie de 50 000 heures avec une garantie de 5 ans. Equipés de composants de marques reconnues (LED COB et alimentation), allié à un niveau élevé de rendu des couleurs (IRC>90) et un faible éblouissement (UGR <19), ces luminaires sont hautement qualitatifs.

Une garantie de 5 ans accordée conformément aux termes de la déclaration de garantie disponible sur le site d'Internet

Matériau du boîtier: alliage en aluminium

Matériau vitre de protection: matériau plastique

Kanlux ACORD ATL1 sono degli apparecchi d'illuminazione integrati da montare su binario trifase. Si tratta di lampade che possono essere adattate alle nostre esigenze individuali. Possiamo scegliere tra: bianco o nero, due potenze (20W e 30W), colore della luce e angolo di illuminazione (lo standard è 60°, ma possiamo sostituire il riflettore e cambiare l'angolo a 15° o 36°) a secondo quello che si desidera illuminare la superficie o un dettaglio specifico. Kanlux ACORD ATL1 è sinonimo di 50.000 ore di durata e 5 anni di garanzia. Componenti chiave di marca (LED COB e alimentatore), alto livello di resa cromatica reale (CRI>90) ed eliminazione dell'abbagliamento (UGR<19) sono gli altri vantaggi di questi apparecchi unici.

5 anni di garanzia secondo le condizioni della dichiarazione di garanzia consultabile sul sito www.kanlux.com

per il montaggio sul binario TEAR N

Materiale del corpo: alluminio

Vetro: plastica

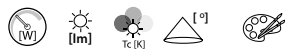

ATL1 18W-930-S6-W	33130	5905339331304	18	1700	3000	60	blanc bianco
ATL1 18W-930-S6-B	33131	5905339331311	18	1700	3000	60	noir nero
ATL1 18W-940-S6-W	33132	5905339331328	18	1800	4000	60	blanc bianco
ATL1 18W-940-S6-B	33133	5905339331335	18	1800	4000	60	noir nero
ATL1 30W-930-S6-W	33134	5905339331342	30	2850	3000	60	blanc bianco
ATL1 30W-930-S6-B	33135	5905339331359	30	2850	3000	60	noir nero
ATL1 30W-940-S6-W	33136	5905339331366	30	3000	4000	60	blanc bianco
ATL1 30W-940-S6-B	33137	5905339331373	30	3000	4000	60	noir nero

[V] 220-240 AC	[Hz] 50	 ≥30000	 50000	 ellipse ≤60 Macadam	 Ra 90	 COB			 IP 20	
 5+25		 315	 90	 0,5m						

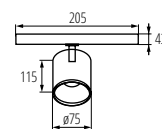

ATL1 18W-930-S6

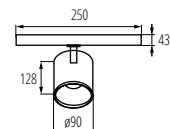

ATL1 30W-930-S6

ACORD ATL1

PROJECTEUR POUR MONTAGE SUR RAIL ► PROIETTORE PER BINARIO



ATL1 18W



ATL1 18W



ATL1 30W



ATL1 30W

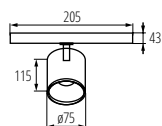

ATL1 18W-930-S6

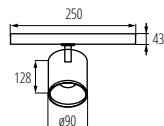

ATL1 30W-930-S6

AKCESORIA ► ACCESSORIES

REF ATL1-18W-S15	33140	5905339331403	Projecteur pour le luminaire ATL 1, 18W, 15 degrés Proiettore per apparecchio ATL1, 18W, 15 gradi
REF ATL1-18W-S36	33141	5905339331410	Projecteur pour le luminaire ATL 1, 18W, 36 degrés Proiettore per apparecchio ATL1, 18W, 36 gradi
REF ATL1-30W-S15	33142	5905339331427	Projecteur pour le luminaire ATL 1, 30W, 15 degrés Proiettore per apparecchio ATL1, 30W, 15 gradi
REF ATL1-30W-S36	33143	5905339331434	Projecteur pour le luminaire ATL 1, 30W, 36 degrés Proiettore per apparecchio ATL1, 30W, 36 gradi



Kanlux

ACORD ATL2 GU10

PROJECTEUR POUR MONTAGE SUR RAIL ► PROIETTORE PER BINARIO



ATL2 GU10-W



ATL2 GU10-W	33138	5905339331380	blanc bianco	GU10
ATL2 GU10-B	33139	5905339331397	noir nero	GU10

[V] 220-240 AC	[Hz] 50	[W] max 10	PAR16	IP 20	5+25	UK CA
330	100	0,5m	CE	ERL	PZH	UK CA



Les ACORD ATL 2 de Kanlux sont des luminaires prévus pour un montage sur rails triphasées. Prévus pour un fonctionnement avec des sources lumineuses remplaçables, ils peuvent être adaptés à des besoins spécifiques. Ils sont disponibles en finition blanc ou noir. En fonction des besoins, il est possible de choisir bonne couleur, l'angle de diffusion et la puissance souhaités. Les luminaires Kanlux ACORD ATL 1 sont garantis 5 ans.

Matériau du boîtier: alliage en aluminium

Kanlux ACORD ATL 2 sono degli apparecchi d'illuminazione da montare su binario trifase. Si tratta di lampade con una sorgente luminosa sostituibile che può essere adattata alle nostre esigenze individuali. Possiamo scegliere il colore della lampada: tra bianco o nero e una fonte di luce. A seconda delle nostre esigenze, possiamo scegliere il giusto colore, angolazione e potenza.

per il montaggio sul binario TEAR N

Materiale del corpo: alluminio

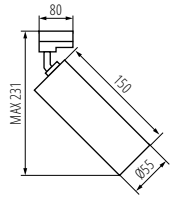

ATL2 GU10

Kanlux

ACORD ATL3 GU10

PROJECTEUR POUR MONTAGE SUR RAIL ► PROIETTORE PER BINARIO



NEW

ATL3 GU10-B



ATL3 GU10-B	33144	5905339331441	GU10	noir nero
ATL3 GU10-W	33145	5905339331458	GU10	blanc bianco

[V] 220-240 AC	[Hz] 50	[W] max 10	PAR16	IP 20	5+25	UK CA
330	90	0,5m	CE	ERL	PZH	UK CA



Kanlux ATL3 sont des luminaires prévus pour un montage sur rails triphasées. Ils sont fabriqués en alliage d'aluminium et disposent d'une source lumineuse remplaçable avec un culot GU10. Les luminaires Kanlux ATL3 ont deux axes de rotation - horizontal 330 degrés et vertical 90 degrés, et vous pouvez également choisir la couleur du luminaire, blanc ou noir. Les lampes Kanlux ACORD ATL bénéficient d'une garantie de 5 ans.

Une garantie de 5 ans accordée conformément aux termes de la déclaration de garantie disponible sur le site d'Internet

Matériau du boîtier: alliage en aluminium

Kanlux ATL3 sono faretti per binari trifase. Sono realizzati in alluminio e funzionano con una lampada gu10. I faretti Kanlux ATL3 sono regolabili da due assi: - orizzontalmente per 330° e verticalmente per 90°, Disponibili nei colori bianco o nero. 5 anni di garanzia

5 anni di garanzia secondo le condizioni della dichiarazione di garanzia consultabile sul sito Internet

Materiale del corpo: alluminio

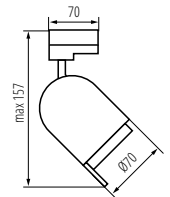

ATL3 GU10

Kanlux

ACORD ATL4 GU10

PROJECTEUR POUR MONTAGE SUR RAIL ► PROIETTORE PER BINARIO



NEW

ATL4 GU10-B



ATL4 GU10-B	33146	5905339331465	GU10	noir nero
ATL4 GU10-W	33147	5905339331472	GU10	blanc bianco

[V] 220-240 AC	[Hz] 50	[W] max 10	PAR16	IP 20	CE
5+25	330	90	0,5m		
ERC	CDK				



Kanlux ATL4 sont des luminaires prévus pour un montage sur rails triphasées. Ils sont fabriqués en alliage d'aluminium et disposent d'une source lumineuse remplaçable avec un culot GU10. Les luminaires Kanlux ATL4 ont deux axes de rotation - horizontal 330 degrés et vertical 90 degrés, et vous pouvez également choisir la couleur du luminaire, blanc ou noir. Les lampes Kanlux ACORD ATL bénéficient d'une garantie de 5 ans.

Une garantie de 5 ans accordée conformément aux termes de la déclaration de garantie disponible sur le site d'Internet

Matériau du boîtier: alliage en aluminium

Kanlux ATL4 sono faretti per binari trifase. Sono realizzati in alluminio e funzionano con una lampada gu10. I faretti Kanlux ATL4 sono regolabili su due assi: - orizzontalmente per 330° e verticalmente per 90°. Disponibili nei colori bianco o nero. 5 anni di garanzia.

5 anni di garanzia secondo le condizioni della dichiarazione di garanzia consultabile sul sito Internet

Materiale del corpo: alluminio

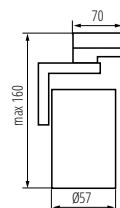

ATL4 GU10

Kanlux

ACORD ATL5 GU10

PROJECTEUR POUR MONTAGE SUR RAIL ► PROIETTORE PER BINARIO



NEW

ATL5 GU10-W



ATL5 GU10-B	33148	5905339331489	GU10	noir nero
ATL5 GU10-W	33149	5905339331496	GU10	blanc bianco

[V] 220-240 AC	[Hz] 50	[W] max 10	PAR16	IP 20	CE
5+25	330	90	0,5m		
ERC	CDK				



Kanlux ATL5 sont des luminaires prévus pour un montage sur rails triphasées. Ils sont fabriqués en alliage d'aluminium et disposent d'une source lumineuse remplaçable avec un culot GU10. Les luminaires Kanlux ATL5 ont deux axes de rotation - horizontal 330 degrés et vertical 120 degrés, et vous pouvez également choisir la couleur du luminaire, blanc ou noir. Les lampes Kanlux ACORD ATL bénéficient d'une garantie de 5 ans.

Une garantie de 5 ans accordée conformément aux termes de la déclaration de garantie disponible sur le site d'Internet

Matériau du boîtier: alliage en aluminium

Kanlux ATL5 sono faretti per binari trifase. Sono realizzati in alluminio e funzionano con una lampada gu10. I faretti Kanlux ATL5 sono regolabili su due assi: - orizzontalmente per 330° e verticalmente per 120°. Disponibili nei colori bianco o nero. 5 anni di garanzia.

5 anni di garanzia secondo le condizioni della dichiarazione di garanzia consultabile sul sito Internet

Materiale del corpo: alluminio

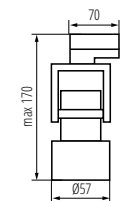

ATL5 GU10

BTL LED

PROJECTEUR POUR MONTAGE SUR RAIL ► PROIETTORE PER BINARIO



BTL 18W-930-W



BTL 18W-930-B



BTL 18W-940-W



Kanlux BTL LED c'est un nouveau design de projecteurs adaptés au système Kanlux TEAR et à la plupart des systèmes de rails à 3 circuits. Les luminaires sont équipés d'une alimentation électrique intégrée à l'adaptateur. Kanlux BTL sont des luminaires directionnels avec lentille et réglage de l'angle de diffusion de 15° à 45°. En option, un diffuseur avec une structure en nid d'abeille peut être utilisé pour réduire l'éblouissement. Kanlux BTL sont disponibles en 18W, 28W et 38W, deux couleurs du boîtier (blanc ou noir) et deux teintes de la lumière (chaude ou neutre). Les luminaires de la gamme Kanlux BTL ont un indice de rendu des couleurs élevé Ra 90+, et leur qualité de fabrication est confirmée par une garantie de 5 ans.

Une garantie de 5 ans accordée conformément aux termes de la déclaration de garantie disponible sur le site d'Internet

Matériau du boîtier: alliage en aluminium

Kanlux BTL LED è un nuovo gruppo di faretti di design adatti ai binari Kanlux TEAR e alla maggior parte dei binari trifase. Gli apparecchi sono dotati di alimentatore integrato con l'adattatore. I Kanlux BTL permettono di modificare a piacere l'angolo di rifrazione della luce fra da 15° a 45°. E' inoltre possibile abbinare opzionalmente un diffusore con struttura a nido d'ape che riduce l'abbagliamento. In Kanlux BTL sono disponibili in varie potenze (18W 28W 38W), in due colori (bianco o nero) edue temperature della luce (calda o neutra). La serie di apparecchi Kanlux BTL ha un elevato indice di resa cromatica Ra 90+ e la loro alta qualità è confermata da una garanzia di 5 anni.

5 anni di garanzia secondo le condizioni della dichiarazione di garanzia consultabile sul sito Internet

Materiale del corpo: alluminio



BTL 18W-930-W	35650	5905339356505	18	1800	3000	15-45	blanc bianco
BTL 18W-930-B	35651	5905339356512	18	1750	3000	15-45	noir nero
BTL 18W-940-W	35652	5905339356529	18	1800	4000	15-45	blanc bianco
BTL 18W-940-B	35653	5905339356536	18	1750	4000	15-45	noir nero
BTL 28W-930-W	35654	5905339356543	28	3000	3000	15-45	blanc bianco
BTL 28W-930-B	35655	5905339356550	28	2800	3000	15-45	noir nero
BTL 28W-940-W	35656	5905339356567	28	3000	4000	15-45	blanc bianco
BTL 28W-940-B	35657	5905339356574	28	2800	4000	15-45	noir nero
BTL 38W-930-W	35658	5905339356581	38	4000	3000	15-45	blanc bianco
BTL 38W-930-B	35659	5905339356598	38	3800	3000	15-45	noir nero
BTL 38W-940-W	35660	5905339356604	38	4000	4000	15-45	blanc bianco
BTL 38W-940-B	35661	5905339356611	38	3800	4000	15-45	noir nero

[V] 220-240 AC	[Hz] 50	⚡ ≥30000	⌚ 50000	☀️ diffuse ≤6 MacAdam	☀️ Ra 90	🔲 COB
🌀	📐 IP 20	🏠	🌡️ 5+25	🔌	🔄 340	
🔄 90	📏 0,5m	CE	ERL	UK	🌱	

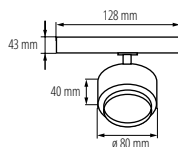

BTL 18W

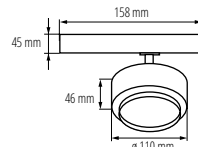

BTL 28W

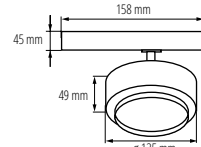

BTL 38W

BTLW LED

PROJECTEUR POUR MONTAGE SUR RAIL ▶ PROIETTORE PER BINARIO



BTLW 18W-930-W



BTLW 18W-930-W



BTLW 18W-930-B



BTLW 18W-940-W



BTLW 18W-930-W	35662	5905339356628	18	1450	3000	120	blanc bianco
BTLW 18W-930-B	35663	5905339356635	18	1400	3000	120	noir nero
BTLW 18W-940-W	35664	5905339356642	18	1450	4000	120	blanc bianco
BTLW 18W-940-B	35665	5905339356659	18	1400	4000	120	noir nero



Kanlux BTLW LED c'est un nouveau design de projecteurs adaptés au système Kanlux TEAR et à la plupart des systèmes de rails à 3 circuits. Les luminaires sont équipés d'une alimentation électrique intégrée à l'adaptateur. Les projecteurs Kanlux BTLW se caractérisent par un diffuseur opaque, assurant un large angle de diffusion de 120°. Ils sont disponibles en 18W, en deux couleurs de boîtier (blanc ou noir) et en deux teintes de lumière. Ils sont adaptés aux usages privés comme l'éclairage principal et partout où un grand angle d'éclairage est nécessaire.

Une garantie de 5 ans accordée conformément aux termes de la déclaration de garantie disponible sur le site d'Internet

Matériau du boîtier: alliage en aluminium

Kanlux BTLW LED è un nuovo gruppo di faretto di design adatti ai binari Kanlux TEAR e alla maggior parte dei binari trifase. Gli apparecchi sono dotati di alimentatore integrato con l'adattatore. I Kanlux BTLW sono caratterizzati da una lampada con diffusore opalino, un ampio angolo di rifrazione di 120°. Sono da 18W, disponibili in due colori (bianco o nero) e due temperature di luce (calda e neutra). Sono perfetti per ambienti domestici, come illuminazione primaria e ovunque sia necessario un ampio angolo del fascio luminoso.

5 anni di garanzia secondo le condizioni della dichiarazione di garanzia consultabile sul sito Internet

Materiale del corpo: alluminio

[V] 220-240 AC	[Hz] 50	[h] ≥30000	[h] 50000	[lm] ≤ 6x MacAdam	Ra 90	[C] COB
[IP] 20	[°C] 5+25	[°] 90	[m] 0,5m	[m] 340	[m] 340	[m] 340
[m] 90	[m] 0,5m	[m] 340	[m] 340	[m] 340	[m] 340	[m] 340

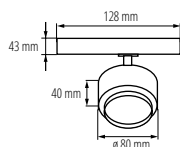

BTLW 18W-930-W

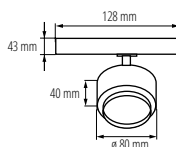

BTLW 18W-930-B

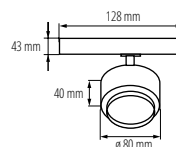

BTLW 18W-940-W

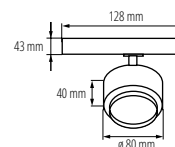























BTLW 18W-940-B

Kanlux

TEAR N

ACCESSOIRE POUR SYSTÈME DE RAILS ► ACCESSORI DEL SISTEMA A BINARIO

	TEAR N TR 1M-W	33230	5905339332301	Rail 3 allumages, longueur 1m, blanc, (33230) Elemento di sistema a sbarra , trifase TEAR N TR 1M-W,bianco
	TEAR N TR 1M-B	33231	5905339332318	Rail 3 allumages, longueur 1m, noir, (33231) Elemento di sistema a sbarra , trifase TEAR N TR 1M-B,nero
	TEAR N TR 2M-W	33232	5905339332325	Rail 3 allumages, longueur 2m, blanc, (33232) Elemento di sistema a sbarra , TEAR N TR 2M-W, 3 circuits, bianco, (33232)
	TEAR N TR 2M-B	33233	5905339332332	Rail 3 allumages, longueur 2m, noir, (33233) Elemento di sistema a sbarra , trifase TEAR N TR 1M-B,nero (33233)
	R  TEAR N PCON R-W	33234	5905339332349	Alimentation avec fiche droite, R, blanc, (33234) Elemento di sistema a sbarra , TEAR N PCON R-W,bianco (33234)
	R  TEAR N PCON R-B	33235	5905339332356	Alimentation avec fiche droite, R, noir (33235) Elemento di sistema a sbarra , TEAR N PCON R-W,nero (33235)
	L  TEAR N PCON L-W	33260	5905339332608	Alimentation avec fiche gauche L, noir, (33260) Elemento di sistema a sbarra ,TEAR N PCON L-W ,bianco (33260)
	L  TEAR N PCON L-B	33261	5905339332615	Alimentation avec fiche gauche L, noir, (33261) Elemento di sistema a sbarra,TEAR N PCON L-B ,nero (33261)
	TEAR N EPLUG W	33236	5905339332363	Embout de fermeture, blanc, (33236) Tappo per binario TEAR N EPLUG W ,bianco (33236)
	TEAR N EPLUG B	33237	5905339332370	Embout de fermeture, noir, (33237) Tappo per binario TEAR N EPLUG B ,nero (33237)
	L  R TEAR N ICON-I W	33238	5905339332387	Connecteur interne droit de type „I“,avec fiche L et R, , blanc, (33238) Connettore lineare integrato TEAR N ICON-I W,bianco (33238)
	L  R TEAR N ICON-I B	33239	5905339332394	Connexion interne droit de type „I“, avec fiche L et R, noir, (33239) Connettore lineare integrato TEAR N ICON-I B,nero (33239)
	L  R TEAR N CON-I W	33240	5905339332400	Connecteur droit de type „I“, avec fiche L et R, blanc, (33240) Connettore lineare integrato TEAR N CON-I W,bianco (33240)
	L  R TEAR N CON-I B	33241	5905339332417	Connecteur droit de type „I“, avec fiche L et R, noir, (33241) Connettore lineare integrato TEAR N CON-I B,nero (33241)
	L  R TEAR N CON-I FLEX W	33252	5905339332523	Connecteur flexible de type „I“, avec fiche L et R, blanc, (33252) Connettore flessibile TEAR N CON-I FLEX W,bianco (33252)
	L  R TEAR N CON-I FLEX B	33253	5905339332530	Connecteur flexible de type „I“, avec fiche L et R, noir, (33253) Connettore flessibile TEAR N CON-I FLEX B.nero (33253)
	R  L TEAR N CON-L RL-W	33242	5905339332424	Connecteur 90° de type „L“, avec fiche R et L, blanc, (33242) Connettore a L TEAR N CON-L RL-W,bianco (33242)
	R  L TEAR N CON-L RL-B	33243	5905339332431	Connecteur 90° de type „L“, avec fiche R et L, noir, (33243) Connettore a L TEAR N CON-L RL-B,nero (33243)
	L  R TEAR N CON-L LR-W	33244	5905339332448	Connecteur 90° de type „L“, avec fiches L et R, blanc, (33244) Connettore a L TEAR N CON-L LR-W,bianco (33244)
	L  R TEAR N CON-L LR-B	33245	5905339332455	Connecteur 90° de type „L“, avec fiches L et R, noir, (33245) Connettore a L TEAR N CON-L LR-B,nero (33245)
	R  L TEAR N CON-X W	33246	5905339332462	Connecteur croix de type „X“, avec fiche L,L,R,R, blanc, (33246) Connettore a X TEAR N CON-X W,bianco (33246)
	R  L TEAR N CON-X B	33247	5905339332479	Connecteur croix de type „X“, avec fiche L,L,R,R, noir, (33247) Connettore a X TEAR N CON-X B,nero (33247)

		TEAR N CON-T RRL-W	33248	5905339332486	Connecteur de type „T”, avec fiche R,R,L, blanc, (33248) Connettore a T TEAR N CON-T RRL-W,bianco (33248)
		TEAR N CON-T RRL-B	33249	5905339332493	Connecteur de type „T”, avec fiche R,R,L, noir, (33249) Connettore a T TEAR N CON-T RRL-B,nero (33249)
		TEAR N CON-T RLL-W	33250	5905339332509	Connecteur de type „T”, avec fiche R,L,L, blanc, (33250) Connettore a T TEAR N CON-T RLL-W,bianco (33250)
		TEAR N CON-T RLL-B	33251	5905339332516	Connecteur de type „T”, avec fiche R,L,L, noir, (33251) Connettore a T TEAR N CON-T RLL-B,nero (33251)
		TEAR N CON-T LRR-W	33262	5905339332622	Connecteur de type „T”, avec fiche L,R,R, blanc, (33262) Connettore a T TEAR N CON-T LRR-W,bianco (33262)
		TEAR N CON-T LRR-B	33263	5905339332639	Connecteur de type „T”, avec fiche L,R,R, noir, (33263) Connettore a T TEAR N CON-T LRR-B,nero (33263)
		TEAR N CON-T LLR-W	33264	5905339332646	Connecteur de type „T”, avec fiche L,L,R, blanc, (33264) Connettore a T TEAR N CON-T LLR-W,bianco (33264)
		TEAR N CON-T LLR-B	33265	5905339332653	Connecteur de type „T”, avec fiche L,L,R, noir, (33265) Connettore a T TEAR N CON-T LLR-B,nero (33265)
		TEAR N SKIT W	33256	5905339332561	Filin de suspension réglable 2m, blanc, (33256) Cavetto di sospensione per binario regolabile - metri 2 TEAR N SKIT W, bianco (33256)
		TEAR N SKIT B	33257	5905339332578	Filin de suspension réglable 2m, noir, (33257) Cavetto di sospensione per binario regolabile - metri 2 TEAR N SKIT B, nero (33257)
		TEAR N SCLAMP W	33254	5905339332547	Élément de renfort de rails, blanc, (33254) Supporto di montaggio TEAR N SCLAMP W,bianco (33254)
		TEAR N SCLAMP B	33255	5905339332554	Élément de renfort de rails, noir, (33255) Supporto di montaggio TEAR N SCLAMP B,nero (33255)
		TEAR N PADAPTOR-W	33266	5905339332660	Élément adaptateur pour suspension, blanc,, (33266) Adattatore per sospensione , TEAR N PADAPTOR-W, colore bianco (33266)
		TEAR N PADAPTOR-B	33267	5905339332677	Élément adaptateur pour suspension, noir, (33267) Adattatore per sospensione , TEAR N PADAPTOR-B, colore nero (33267)



		TEAR N R-TR 2M-W	35800	5905339358004	Rail encastré TEAR N R-TR 2M-W, rail 3 allumages, longueur 2m, blanc (35800) Binario trifase a incasso TEAR N R-TR 2M-W, (35800)
		TEAR N R-TR 2M-B	35801	5905339358011	Rail encastré TEAR N R-TR 2M-B, rail 3 allumages, longueur 2m, noir (35801) Binario trifase a incasso TEAR N R-TR 2M-B, colore nero (35801)
		TEAR N RC-PCON W	35790	5905339357908	Alimentation pour rail encastré, TEAR N RC-PCON W, blanc, (35790) Cover terminale per schermare l'alimentatore- colore bianco (35790)
		TEAR N RC-PCON B	35791	5905339357915	Alimentation pour rail encastré, TEAR N RC-PCON B, noir, (35791) Cover terminale per schermare l'alimentatore- colore nero (35791)
		TEAR N RC-CON-H W	35794	5905339357946	Élément de connexion droite pour rail encastré, connexion type ‚I ‚, TEAR N RC-PCON W, blanc, (35794) Cover lineare tipo „I” per schermare il connettore di giunzione - colore bianco (35794)
		TEAR N RC-CON-H B	35795	5905339357953	Élément de connexion droite pour rail encastré, connexion type ‚I ‚, TEAR N RC-PCON B, nero, (35795) Cover lineare tipo „I” per schermare il connettore di giunzione - colore nero (35795)
		TEAR N RC-CON-L W	35792	5905339357922	Élément de connexion pour rail encastré, connexion 90° type ‚L” pour système de rails TEAR N RC-PCON W, blanc, (35792) Cover tipo „L” per schermare la giunzione a L - colore bianco (35792)

TEAR N

AKCESORIUM SYSTEMU SZYNOPRZEWODOWEGO ► ACCESSORI DEL SISTEMA A BINARIO

	TEAR N RC-CON-LB	35793	5905339357939	Élément de connexion pour rail encastré, connexion 90° type „L” pour système de rails TEAR N RC-PCON B, noir, (35792) Cover tipo „L” per schermare la giunzione a L - colore nero (35792)
	TEAR N RC-CON-XW	35798	5905339357984	Élément de connexion pour rail encastré, connexion type „X” pour système de rails TEAR N RC-PCON W, blanc, (35798) Cover tipo „X” per schermare la giunzione a X - colore bianco (35798)
	TEAR N RC-CON-XB	35799	5905339357991	Élément de connexion pour rail encastré, connexion type „X” pour système de rails TEAR N RC-PCON B, noir, (35799) Cover tipo „X” per schermare la giunzione a X - colore nero (35799)
	TEAR N RC-CON-TW	35796	5905339357960	Élément de connexion pour rail encastré, connexion type „T” pour système de rails TEAR N RC-PCON W, blanc, (35796) Cover tipo „T” per schermare la giunzione a T - colore bianco (35796)
	TEAR N RC-CON-TB	35797	5905339357977	Élément de connexion pour rail encastré, connexion type „T” pour système de rails TEAR N RC-PCON B, noir, (35797) Cover tipo „T” per schermare la giunzione a T - colore nero (35797)
	TEAR N RCLIP-W	35802	5905339358028	Element pour rail encastré, clips de fixation, blanc, (35802) Supporto per ancoraggio binario - colore bianco (35802)
	TEAR N RCLIP-B	35803	5905339358035	Element pour rail encastré, clips de fixation, noir, (35803) Supporto per ancoraggio binario - colore nero (35803)

Kanlux TEAR N Schéma de connexion Schema collegamenti

TEAR N RC Couverture de fermeture pour rail encastré TEAR N R-TR
Cover per binario ad incasso
TEAR N R-TR

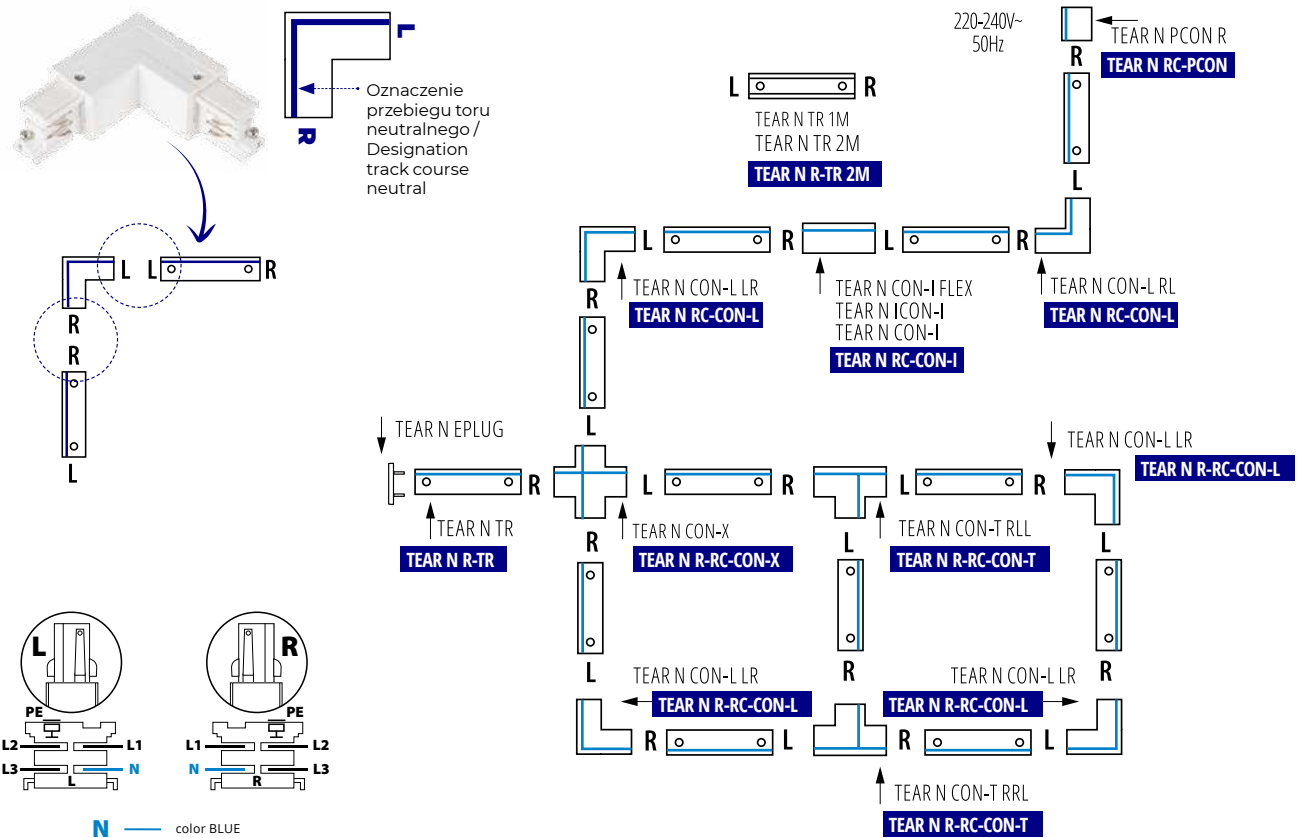

TEAR N PADAPTOR

ACCESSOIRE POUR SYSTÈME DE RAILS
 ► ACCESSORI DEL SISTEMA A BINARIO



TEAR N PADAPTOR-W



TEAR N PADAPTOR-B



TEAR N PADAPTOR-W	33266	5905339332660	blanc bianco
TEAR N PADAPTOR-B	33267	5905339332677	noir nero

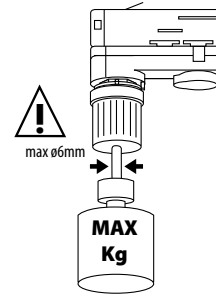
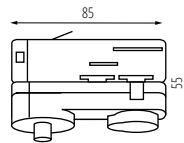

!	
max kg	
2 x 0,75	2,2
2 x 1,00	2,9
3 x 0,75	3,3
3 x 1,00	4,4

[V] 220-240 AC	[Hz] 50	In[A] 10		IP 20		 5+25



Kanlux



EQUIPEMENTS CONNECTES KANLUX SMART PRODOTTI SMART

Les solutions Kanlux Smart sont simples à installer, et tout utilisateur peut réaliser lui-même l'installation en toute autonomie. Il est possible de connecter des appareils tels que lampes, luminaires, radiateurs, ... - ou bien d'y rattacher de nouveaux appareils tels que caméras ou détecteurs. Grâce à cette solution technique, il est aisé de mettre en place un système de domotique connectée sans avoir à faire ni gros travaux, ni trous dans les murs.

I dispositivi Kanlux SMART sono molto facili da configurare, chiunque può farlo. Inoltre possono essere utilizzati con altri dispositivi già in uso. Lampade, fotocamere e sensori ti consentiranno di iniziare a controllare la tua casa in qualsiasi momento ed ovunque tu sia senza alcuna modifica strutturale.

*Données photométriques et plugin
Dialux sont téléchargeables sur:
Dati fotometrici consultabili su:*



► kanlux.com

Pilotez les produits Kanlux SMART avec l'application mobile SMART LIFE

Utilizza l'applicazione SMART LIFE
dal tuo dispositivo mobile



Kanlux

KANLUX SMART

► SENSORE PORTA/FINESTRA



S SENSOR ON/OFF INT



S SENSOR ON/OFF INT | 34942 | 5905339349422 | 2 x 1,5 DC | 2 x AAA

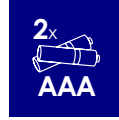

Une fenêtre ou une porte ouverte sur la terrasse - on se demande souvent si on l'a fermée, après avoir quitté la maison. Le capteur de fenêtre/porte nous montrera leur statut. Lors de l'installation sur la porte d'entrée, la terrasse, le balcon ou la fenêtre, pendant le voyage, nous ne devons pas nous demander si tout va bien dans la maison. Le capteur vérifiera les fenêtres et les portes, et nous prenons connaissance de l'ouverture possible à partir de l'application sur notre appareil mobile. Une alarme nous informera du niveau de pile faible. Pour en savoir plus sur Kanlux SMART sur www.kanluxsmart.com.

Una finestra o una porta aperta sul terrazzo: spesso ci chiediamo se l'abbiamo chiusa dopo essere usciti di casa. Questo sensore ci mostrerà il loro stato. Quando lo installiamo sulla porta d'ingresso, sul terrazzo, sul balcone o sulla finestra, non dovremo più chiederci se in casa va tutto bene. Il sensore controllerà le finestre e le porte e scopriremo il loro stato attraverso l'applicazione che lo comunicherà al nostro dispositivo mobile. Un allarme ci informerà del livello di batteria basso. Scopri di più su Kanlux SMART su www.kanluxsmart.com.

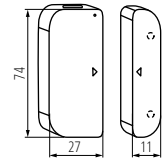

S SENSOR ON/OFF INT

Kanlux

KANLUX SMART

DÉTECTEUR DE MOUVEMENT PIR ► SENSORE DI MOVIMENTO PIR



S SENSOR PIR INT 10M



S SENSOR PIR INT 10M | 34940 | 5905339349408 | 2 x 3V DC / 5V USB | 2 x CR123A



Capteur de détection de mouvement pour une utilisation en intérieur. En le connectant dans l'application aux appareils SMART sélectionnés, il allumera non seulement la lumière lorsqu'un mouvement est détecté, mais lancera également toute action programmée - en fonction des appareils SMART couplés et de la fonction qui leur est attribuée. Le capteur est alimenté par batterie ainsi que par USB. Une alarme nous informera du niveau de pile faible. En savoir plus sur Kanlux SMART sur www.kanluxsmart.com.

Sensore di movimento per uso interno. Collegandolo attraverso l'applicazione ai dispositivi SMART selezionati, non solo accenderà la luce quando viene rilevato un movimento, ma avvierà anche qualsiasi azione programmata, a seconda dei dispositivi SMART associati e della funzione loro assegnata. Il sensore è alimentato a batteria e ricaricabile con USB. Un allarme ci informerà del livello di batteria basso. Scopri di più su Kanlux SMART su www.kanluxsmart.com.

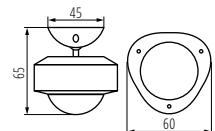

S SENSOR PIR INT 10M

Kanlux

KANLUX SMART

CAPTEUR D'INONDATION ► SENSORE PERDITE ACQUA



S SENSOR W INT



S SENSOR W INT | 34941 | 5905339349415 | 2 x 1,5 DC | 2 x AAA



Le capteur d'inondation nous aidera à réagir à une fuite d'eau d'un tuyau cassé, d'un robinet non-fermé ou à l'inondation d'une maison ou d'un appartement, indépendante de nous. Le capteur doit être placé dans un tel endroit pour qu'il puisse détecter l'eau. Il dispose d'une alarme acoustique intégrée, mais nous recevons également des informations de l'application sur un appareil mobile, même lorsque nous sommes loin de chez nous. Une alarme nous informera du niveau de pile faible. En savoir plus sur Kanlux SMART sur www.kanluxsmart.com.

Il sensore di allagamento segnalerà tutte le perdite d'acqua, ad esempio provenienti da un tubo rotto o da un rubinetto. Il sensore deve essere posizionato in un luogo tale che in caso di allagamento possa rilevare l'acqua. Ha un allarme acustico integrato, ma trasmetterà anche l'allarme dall'applicazione ad un dispositivo mobile associato. Un allarme ci informerà del livello di batteria basso. Scopri di più su Kanlux SMART su www.kanluxsmart.com.

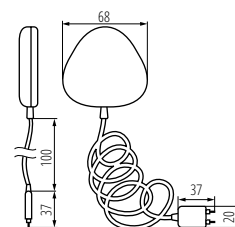

S SENSOR W INT



Kanlux

KANLUX SMART

ADAPTATEUR DE PRISE ► ADATTATORE PER PRESA



S AD GN SCH 10A PM



S AD GN 16A PM

Grâce à l'adaptateur de prise, vous pouvez contrôler (fonction marche/arrêt) des appareils sans fonctions SMART (par exemple : un fer à repasser). On peut également programmer une séquence d'actions de son choix. La fonction de base est marche/arrêt, mais l'adaptateur a aussi une horloge intégrée (horloge hebdomadaire avec calendrier), des fonctions aléatoires et d'une fonction de minuterie/compte à rebours. Cela vous permet de programmer différents appareils pour qu'ils s'allument et s'éteignent à des heures précises, même lorsque vous n'êtes pas chez vous. En outre, l'adaptateur dispose d'une fonction permettant de mesurer la consommation d'énergie (de l'appareil qui y est connecté). Pour en savoir plus sur Kanlux SMART à l'adresse www.kanluxsmart.com.

Grazie all'adattatore per presa, puoi controllare (funzione on/off) dispositivi senza funzioni SMART (es.: un ferro da stiro). Inoltre può anche impostare una sequenza di azioni a tua scelta. La funzione di base è on/off, ma l'adattatore ha anche un timer integrato (timer settimanale con calendario), funzioni random e una funzione conto alla rovescia. Queste funzioni consentono di programmare l'accensione/spengimento dei dispositivi collegati ad orari specifici, anche quando non si è in casa. Inoltre, l'adattatore ha una funzione per misurare il consumo energetico (del dispositivo ad esso collegato). Scopri di più su Kanlux SMART su www.kanluxsmart.com.

			In [A]
S AD GN SCH 10A PM	33701	5905339337016	10
S AD GN 16A PM	33703	5905339337030	16

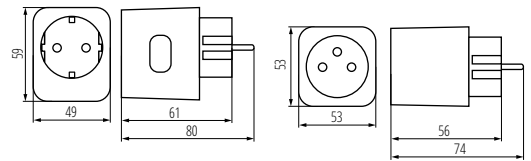

S AD GN SCH 10A PM

S AD GN 16A PM



Kanlux

KANLUX SMART

RELAIS GARAGE ► RELE' GARAGE



S SWITCH G DOOR



S SWITCH G DOOR | 34950 | 5905339349507 | blanc | bianco



Relais de commande de portail avec capteur d'ouverture et de fermeture. Il peut coopérer dans un environnement intelligent avec d'autres boutons dédiés ou virtuels par des fonctions assignées - telles que fermer ou ouvrir. Pour en savoir plus sur Kanlux SMART sur www.kanluxsmart.com.

Relè di comando del cancello con sensore di apertura e chiusura. Questo comando smart permette di aprire e chiudere la basculante del vostro garage da remoto e utilizzando il telefono invece delle chiavi. Scopri di più su Kanlux SMART su www.kanluxsmart.com.

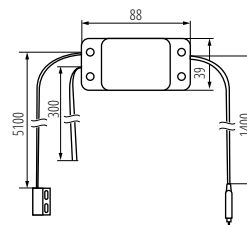

S SWITCH G DOOR

Kanlux

KANLUX SMART

RELAIS WIFI ► RELE' WIFI



S SWITCH ON/OFF



S SWITCH ON/OFF | 34948 | 5905339349484 | blanc | bianco



Relais on/off encastré (boîtiers FI-60). Il nous permet de contrôler les circuits des prises de courant ou des interrupteurs, en leur donnant la fonction SMART sans qu'il soit nécessaire d'effectuer une installation supplémentaire entre eux. Pour en savoir plus sur Kanlux SMART sur www.kanluxsmart.com.

Relè on/off da incasso Ci permette di controllare i circuiti delle prese elettriche o degli interruttori della luce rendendoli SMART senza bisogno di alcun intervento aggiuntivo. Scopri di più su Kanlux SMART su www.kanluxsmart.com.

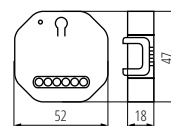

S SWITCH ON/OFF

Kanlux

KANLUX SMART

RELAIS WIFI ► RELE' WIFI



S SWITCH SHUTTER



S SWITCH SHUTTER | 34949 | 5905339349491 | blanc | bianco



Relais encastrable pour la commande de moteurs de volets roulants et volets roulants (boîtiers FI-60). Il nous permet de piloter les volets roulants depuis le niveau d'une application installée sur un appareil mobile. Pour en savoir plus sur Kanlux SMART sur www.kanluxsmart.com.

Relè da incasso per il comando di motori di tende e tapparelle. Ci consente di controllare le tapparelle attraverso un App mobile. Scopri di più su Kanlux SMART su www.kanluxsmart.com.

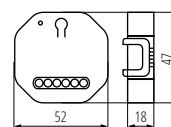

S SWITCH SHUTTER

Kanlux



EQUIPEMENTS ELECTRIQUES

PRODOTTI PER L' INSTALLAZIONE ELETTRICA

Vous voulez ajuster certains paramètres, l'efficacité et la protection thermique contre les courts-circuits et la surcharge. Nous vous proposons des dispositifs dédiés à ces fonctions. Kanlux vous assure confort, fiabilité et sécurité.

Vuoi controllare i parametri della tua abitazione. Verificare l' efficienza termica, ed escludere i cortocircuiti. Ti offriamo prodotti progettati per questi compiti. Garantiamo comfort, affidabilità e sicurezza.



*Données photométriques et plugin
sont téléchargeables sur:
dati fotometrici consultabili su:*

► [kanlux.com](https://www.kanlux.com)

Kanlux

ZONA MINI

DÉTECTEUR DE MOUVEMENT PIR ► SENSORE DI MOVIMENTO PIR



ZONA MINI

Détecteur de mouvement infrarouge ZONA MINI, grâce à ses dimensions compactes (seulement 76 mm de diamètre), s'intégrera parfaitement dans n'importe quelle pièce.

Matériau: matériau plastique

Il sensore di movimento a infrarossi ZONA MINI, grazie alle sue dimensioni compatte (solo 76 mm di diametro), si adatterà perfettamente e discretamente a qualsiasi stanza.

Materiale: plastica

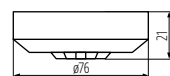
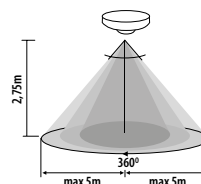

ZONA MINI



ZONA MINI-W | **37364** | 5905339373649 | 200 saillie | montage a soffitto | H360 | PIR | 10-15

[V]	[Hz]	IP						CE	ERC	UK	
220-240 AC	50	20		max 8	3-2000	5+25	0,75+1,5				

Kanlux

ZONA MINI WT

DÉTECTEUR DE MOUVEMENT PIR ► SENSORE DI MOVIMENTO PIR



ZONA MINI WT

Le ZONA MINI WT est une extension de la famille des détecteurs de mouvement infrarouges compacts. La version WT (étanche) se caractérise par un indice de protection IP65 ce qui élargit encore son champ d'application.

Matériau: matériau plastique

ZONA MINI WT è un'estensione della famiglia delle compatte a infrarossi motion sensori. La versione WT (stagna) è caratterizzata da un elevato grado di protezione IP65, ampliando ulteriormente la propria gamma di applicazioni.

Materiale: plastica

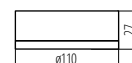
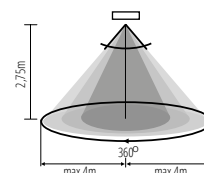

ZONA MINI WT



ZONA MINI WT-W | **37365** | 5905339373656 | 2000 saillie | montage a soffitto | H360 | PIR | 10-30

[V]	[Hz]	IP						CE	ERC	UK	
220-240 AC	50	65\20		max 8	3-2000	-20+40	0,75+1,5				

SENTO-O

DÉTECTEUR DE MOUVEMENT PIR ► SENSORE DI MOVIMENTO PIR



SENTO-O-WT-W



SENTO-O-WT-B

Kanlux SENTO-O est un capteur électronique de mouvement. Un seul capteur peut contenir jusqu'à trois détecteurs infrarouges dans un seul capteur. Cela garantit une sensibilité sans précédent et permet de capter le moindre mouvement. Kanlux SENTO, en raison de ses caractéristiques uniques, est appelé „détecteur de présence". L'avantage supplémentaire est l'installation universelle encastré ou en saillie.

Matériau: matériau plastique

Kanlux SENTO-O è un sensore elettronico di movimento rilevamento. La sua eccezionalità sta nel fatto che altrettanti poiché in un sensore sono installati tre rilevatori a infrarossi. Questo garantisce una sensibilità senza precedenti e te lo permette per catturare anche il minimo movimento. Kanlux SENTO, per le sue caratteristiche uniche, viene definito presenza sensori. Il vantaggio aggiuntivo è l'installazione universale - da incasso e da superficie.

Materiale: plastica

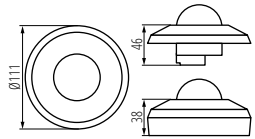
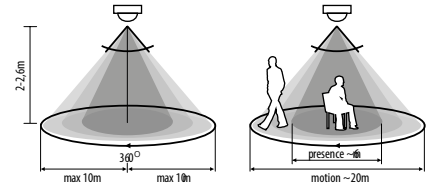

SENTO-O-WT

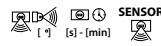

SENTO-O-WT-W	37366	5905339373663	2000	saillie, à encastrer dans le plafond montaggio a soffitto, per montaggio a incasso nel soffitto	H360	10-30	3xPIR
SENTO-O-WT-B	37367	5905339373670	2000	saillie, à encastrer dans le plafond montaggio a soffitto, per montaggio a incasso nel soffitto	H360	10-30	3xPIR

[V]	[Hz]	IP							CE	EAC	UK CA	
220-240 AC	50	44/20			max 20	3-2000	-20+40	0,75+1,5				

SENSQUARE

DÉTECTEUR DE MOUVEMENT PIR ► SENSORE DI MOVIMENTO PIR



SENSQUARE-W



SENSQUARE-B

Les détecteurs SENSQUARE sont conçus pour un montage mural et utilisent la technologie infrarouge. La combinaison d'une large plage de détection et d'un indice de protection IP54 permet d'adapter le capteur à de nombreuses applications. Un avantage supplémentaire du capteur est l'accessoire inclus qui permet de monter le capteur sur les les angles internes et externes. Disponible en noir et blanc.

Matériau: matériau plastique

I sensori SENSQUARE sono progettati per il montaggio a parete e utilizzare la tecnologia a infrarossi. La combinazione di un unico consente un ampio raggio di rilevamento e un grado di protezione IP54 per l'adattamento del sensore a molte applicazioni. Un ulteriore vantaggio del sensore è la dotazione accessorio che permette di montare il sensore su entrambi angoli interni ed esterni. Disponibile in bianco e nero.

Materiale: plastica

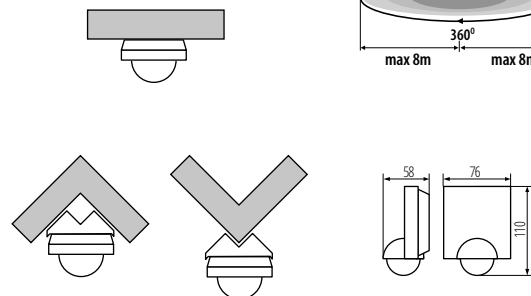
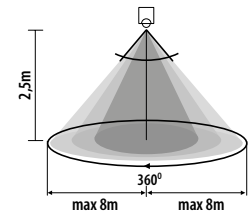

SENSQUARE

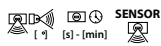

SENSQUARE-W	37368	5905339373687	1200	mural montaggio a parete	H360	10-15	PIR
SENSQUARE-B	37369	5905339373694	1200	mural montaggio a parete	H360	10-15	PIR

[V]	[Hz]	IP							CE	EAC	UK CA	
220-240 AC	50	54			max 8	3-2000	-20+40	0,75+1,5				

Kanlux

MERGE-WT

DÉTECTEUR DE MOUVEMENT PIR ► SENSORE DI MOVIMENTO PIR



MERGE-WT-0-W

Détecteur de mouvement infrarouge compact MERGE-WT. La portée maximale de détection est de 8 mètres et l'angle de détection horizontal est de 360 degrés. Vous pouvez régler la durée d'éclairage et le niveau d'intensité lumineuse. Le capteur possède un indice de protection élevé (IP65).

Matériau: matériau plastique

Sensore di movimento a infrarossi compatto MERGE-WT. La massima rilevazione la portata è di 8 metri e l'angolo di rilevamento orizzontale è di 360 gradi. Puoi regolare la durata dell'illuminazione e il livello di intensità luminosa a cui si trova il sensore opera. Il vantaggio del sensore è il suo elevato grado di protezione IP65.

Materiale: plastica

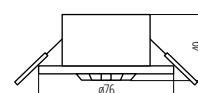
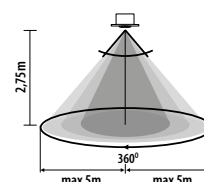

MERGE-WT-0-W



MERGE-WT-0-W | **37370** | 5905339373700 | 1200 | à encastrer dans le plafond | per montaggio a incasso nel soffitto | H360 | 10-30 | PIR

[V]	[Hz]	IP	🏠	◻	max 8	3-2000	-20+40	📦	0,75+1,5	CE	EAC	UK CA	🔽
220-240 AC	50	65\20											

Kanlux

SLICK JQ

DÉTECTEUR DE MOUVEMENT PIR ► SENSORE DI MOVIMENTO PIR



SLICK JQ-L-W



SLICK JQ-L-B

Kanlux SLICK JQ est un capteur de mouvement avec une portée maximale de détection de mouvement de 12 m. Il est possible de régler le temps d'éclairage ainsi que le niveau d'intensité lumineuse avec laquelle le capteur fonctionne.

Matériau: matériau plastique

Kanlux SLICK JQ è il sensore di movimento con un campo massimo di rilevamento del movimento pari a 12 metri. È possibile regolare sia il tempo di illuminazione che il livello di illuminamento esterno a cui il sensore funziona.

Materiale: plastica

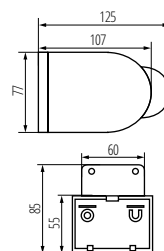
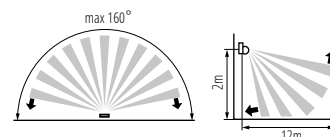

SLICK JQ

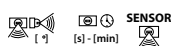

SLICK JQ-L-W | **08390** | 5905339083906 | 1200 | mural | montaggio a parete | H160/V20 | 8-10 | PIR
 SLICK JQ-L-B | **08391** | 5905339083913 | 1200 | mural | montaggio a parete | H160/V20 | 8-10 | PIR

[V]	[Hz]	IP	🏠	◻	max 12	3-2000	-10+40	📦	1+2,5	CE	EAC	UK CA	🔽
220-240 AC	50	44											

Kanlux

ALER MINI

DÉTECTEUR DE MOUVEMENT PIR ► SENSORE DI MOVIMENTO PIR



ALER MINI-W

ALER MINI est un détecteur de mouvement infra-rouge avec un design minimaliste et attrayant. La plage de détection horizontale est de 140°, la plage verticale est de 45°, et grâce à son mécanisme d'inclinaison (verticalement sur 45°, horizontalement sur 90°) il peut s'adapter à tous vos besoins. De par son étanchéité (IP44), ce détecteur peut être installé dans des endroits exposés aux intempéries.

Portée maximale de détection de mouvement de 8 m

Angle horizontal maximal du capteur de mouvement de 140°

Possibilité de régulation de temps d'éclairage de 10 s. à 15 min.

Possibilité de régler l'intensité de la lumière ambiante à laquelle l'appareil fonctionne

Matériau: matériau plastique

ALER MINI-W è un piccolo sensore a infrarossi dall'aspetto d'effetto e minimalista. Il sensore funziona con l'angolo orizzontale di 140° e con quello verticale di 45°, e grazie alla facile regolazione meccanica (in verticale 45°, in orizzontale 90°) è possibile adattarlo alle proprie esigenze. È dotato dell'elevato grado di protezione (IP44) che lo rende adatto all'installazione in luoghi direttamente esposti agli agenti atmosferici.

Portata massima di rilevamento del movimento di 8 m

Angolo orizzontale massimo del sensore di movimento di 140°

Possibilità di regolazione del tempo di accensione tra 10 s. e 15 minuti

Possibilità di regolare l'intensità della luce ambientale in cui opera il dispositivo

Materiale: plastica

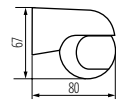
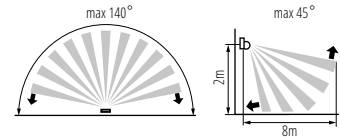

ALER MINI



SENSOR

ALER MINI-W | 23450 | 5905339234506 | 800 | mural | montaggio a parete | H140/V45 | 10-15 | PIR

[V]	[Hz]	IP										
220-240 AC	50	44			max 8	3-2000	-20+40	1+2,5				

Kanlux

ALER JQ

DÉTECTEUR DE MOUVEMENT PIR ► SENSORE DI MOVIMENTO PIR



ALER JQ-30-W



ALER JQ-30-B

Kanlux ALER JQ est un détecteur de mouvement pouvant être efficace jusqu'à 12 mètres. Il est possible d'ajuster la temporisation ainsi que l'intensité lumineuse de fonctionnement.

Matériau: matériau plastique

Kanlux ALER JQ è il sensore di movimento con un campo massimo di rilevamento del movimento pari a 12 metri. È possibile regolare sia il tempo di illuminazione che il livello di illuminamento esterno a cui il sensore funziona.

Materiale: plastica

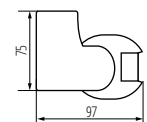
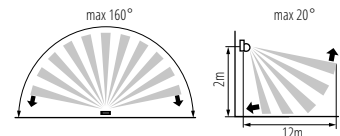

ALER JQ-30



SENSOR

ALER JQ-30-W | 00460 | 5905339004604 | 1200 | mural | montaggio a parete | H160/V20 | 8-7 | PIR
 ALER JQ-30-B | 00461 | 5905339004611 | 1200 | mural | montaggio a parete | H160/V20 | 8-7 | PIR

[V]	[Hz]	IP										
220-240 AC	50	44			max 12	3-2000	-20+40	1+2,5				

Kanlux

ZONA JQ-37

DÉTECTEUR DE MOUVEMENT PIR ► SENSORE DI MOVIMENTO PIR



ZONA JQ-37-B



ZONA JQ-37-W



ZONA JQ-37-B	00463	5905339004635	1200	saillie	montaggio a soffitto	H360/V120	15-7	PIR
ZONA JQ-37-W	00464	5905339004642	1200	saillie	montaggio a soffitto	H360/V120	15-7	PIR

[V] 220-240 AC	[Hz] 50	IP 20			 max 10	 3-2000	 1+2,5				
--------------------------	-------------------	-----------------	--	--	------------	------------	-----------	--	--	--	--

Kanlux ZONA JQ-37 est un détecteur de mouvement avec une portée de détection maximale de 10 mètres. Il est possible de régler le temps d'éclairage ainsi que le niveau d'intensité lumineuse avec lequel le capteur fonctionne. Il est disponible en blanc et en noir.

Matériau: matériau plastique

Kanlux ZONA JQ-37 è un sensore di movimento il cui massimo il raggio di rilevamento è di 10 metri. Possiamo regolare il tempo di illuminazione e il livello di intensità luminosa al quale funziona il sensore. È disponibile nei colori bianco e nero.

Materiale: plastica

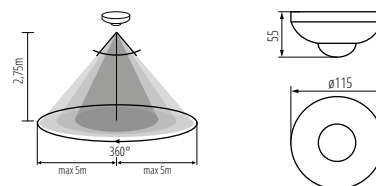

ZONA JQ-37

Kanlux

ZONA

DÉTECTEUR DE MOUVEMENT PIR ► SENSORE DI MOVIMENTO PIR



ZONA FLAT-W



ZONA FLAT-W	23452	5905339234520	2000	saillie	montaggio a soffitto	H360/V120	10-15	PIR
-------------	--------------	---------------	------	---------	----------------------	-----------	-------	-----

[V] 220-240 AC	[Hz] 50	IP 20			 max 8	 3-2000	 5+25	 0,75+1,5				
--------------------------	-------------------	-----------------	--	--	-----------	------------	----------	--------------	--	--	--	--

Kanlux ZONA FLAT est un détecteur de mouvement infrarouge qui détecte sur une portée maximum de 8m. En outre, il détecte sur 360°. Sur le ZONA FLAT, vous pouvez également ajuster la temporisation sur une plage allant de 10s à 15min, et paramétrer le seuil de détection lumineuse.

- portée maximale de détection de mouvement de 8 m
- angle horizontal maximal du capteur de mouvement de 360°
- possibilité de régulation de temps d'éclairage de 10 s. à 15 min.
- possibilité de régler l'intensité de la lumière ambiante à laquelle l'appareil fonctionne
- détection de mouvement de 0,6-1,5m/s
- angle vertical maximal du capteur de mouvement de 120°

Matériau: matériau plastique

Kanlux ZONA FLAT è il sensore di movimento con un campo massimo di rilevamento del movimento di 8m. Invece il suo angolo orizzontale massimo d'esercizio è di 360 gradi. Con il sensore ZONA è possibile regolare il tempo di illuminazione da 10sec a 15min e impostare anche il livello di illuminamento esterno nell'ambiente in cui il dispositivo funzionerà.

- portata massima di rilevamento del movimento di 8 m
- angolo orizzontale massimo del sensore di movimento di 360°
- possibilità di regolazione del tempo di accensione tra 10 s. e 15 minuti
- possibilità di regolare l'intensità della luce ambientale in cui opera il dispositivo
- rilevamento del movimento 0,6-1,5 m / s
- angolo verticale massimo del sensore di movimento 120°

Materiale: plastica

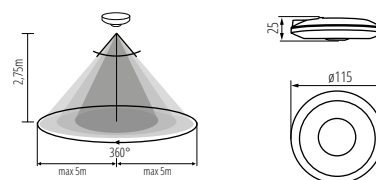

ZONA FLAT

Kanlux

MERGE JQ

DÉTECTEUR DE MOUVEMENT PIR ► SENSORE DI MOVIMENTO PIR



MERGE JQ-L

Kanlux MERGE JQ est un détecteur de mouvement dont la portée maximale est de 5 mètres. L'angle horizontal de fonctionnement du détecteur est de 360 degrés. Vous pouvez régler la durée d'éclairage et le niveau d'intensité lumineuse à laquelle le détecteur fonctionne.

- portée maximale de détection de mouvement de 9 m
- angle horizontal maximal du capteur de mouvement de 150°
- angle vertical maximal du capteur de mouvement de 60°
- possibilité de régulation de temps d'éclairage de 10 s. à 7 min.
- possibilité de régler l'intensité de la lumière ambiante à laquelle l'appareil fonctionne
- charge résistive allant jusqu'à 1200W, charge d'impédance allant jusqu'à 400W
- Matériau: matériau plastique

Kanlux MERGE JQ è un sensore di movimento da incasso in grado di rilevare il movimento fino a 5 metri. È possibile regolare sia il tempo di illuminazione che il livello di illuminamento esterno a cui il sensore funziona. Il sensore può emettere attivato anche un segnale acustico.

- portata massima di rilevamento del movimento di 9 m
- angolo orizzontale massimo del sensore di movimento di 150°
- angolo verticale massimo del sensore di movimento di 60°
- possibilità di regolazione del tempo di accensione tra 10s. e 7 minuti
- possibilità di regolare l'intensità della luce ambientale in cui opera il dispositivo
- carico resistivo fino a 1200 W, carico di impedenza fino a 400 W
- Materiale: plastica

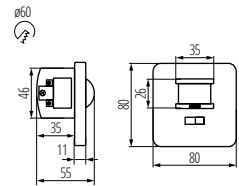
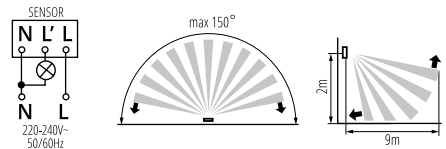

MERGE JQ-L

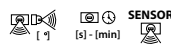

MERGE JQ-L | 07690 | 5905339076908 | 1200 | encastré dans le mur | per montaggio a incasso nella parete | H150/V60 | 10-7 | PIR

[V] 220-240 AC	[Hz] 50	IP 20	max 9	3-2000	5+25	1+2,5	CE	ERC	UK	CA
-------------------	------------	----------	-------	--------	------	-------	----	-----	----	----

Kanlux

MARID JQ

DÉTECTEUR DE MOUVEMENT PIR ► SENSORE DI MOVIMENTO PIR



MARID JQ-L

Kanlux MARID JQ est un capteur de mouvement avec une portée maximale de détection de mouvement de 12 m. Il est possible de régler le temps d'éclairage ainsi que le niveau d'intensité lumineuse avec laquelle le capteur fonctionne. Le capteur peut aussi être activé avec un signal sonore.

- portée maximale de détection de mouvement de 12 m
- angle horizontal maximal du capteur de mouvement de 150°
- angle vertical maximal du capteur de mouvement de 30°
- possibilité de régulation de temps d'éclairage de 10 s. à 7 min.
- possibilité de régler l'intensité de la lumière ambiante à laquelle l'appareil fonctionne
- détection de mouvement de 0,3...3m/s (1...10km/h)
- plage de réglage de la sensibilité 3...1000lx
- possibilité de démarrer le capteur par signal acoustique dans une plage de 30-90dB
- destiné uniquement pour les récepteurs de nature résistante
- Matériau: matériau plastique

Kanlux MARID JQ è il sensore di movimento con un campo massimo di rilevamento del movimento pari a 12 metri. È possibile regolare sia il tempo di illuminazione che il livello di illuminamento esterno a cui il sensore funziona. Il sensore può essere attivato anche tramite un segnale acustico.

- portata massima di rilevamento del movimento di 12 m
- angolo orizzontale massimo del sensore di movimento di 150°
- angolo verticale massimo del sensore di movimento di 30°
- possibilità di regolazione del tempo di accensione tra 10s. e 7 minuti
- possibilità di regolare l'intensità della luce ambientale in cui opera il dispositivo
- rilevamento del movimento di 0,3... 3 m/s (1... 10 km/h)
- campo di regolazione della sensibilità 3... 1000lx
- possibilità di avviare il sensore tramite segnale acustico in un range di 30-90dB
- destinato solo ai recettori di natura resistente
- Materiale: plastica

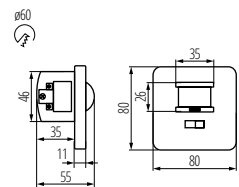
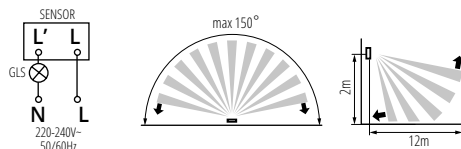

MARID JQ-L

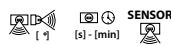

MARID JQ-L | 08910 | 5905339089106 | 40-500 | encastré dans le mur | per montaggio a incasso nella parete | H150/V30 | 10-7 | PIR

[V] 220-240 AC	[Hz] 50	IP 20	max 12	3-2000	5+25	0,75+2,5	CE	ERC	UK	CA
-------------------	------------	----------	--------	--------	------	----------	----	-----	----	----

Kanlux ROLF JQ

DÉTECTEUR DE MOUVEMENT HF ► SENSORE DI MOVIMENTO MW



ROLF JQ-L

Kanlux ROLF JQ est un capteur de mouvement à micro-ondes. L'angle horizontal maximal de fonctionnement du capteur est de 360 degrés. Il est possible de régler le temps d'éclairage ainsi que le niveau d'intensité lumineuse avec laquelle le capteur fonctionne.

- portée maximale de détection de mouvement de 8 m
- angle horizontal maximal du capteur de mouvement de 360°
- angle vertical maximal du capteur de mouvement de 160°
- possibilité de régulation de temps d'éclairage de 5 s. à 12 min.
- possibilité de régler l'intensité de la lumière ambiante à laquelle l'appareil fonctionne
- plage de réglage de la sensibilité 5...2000lx
- détection de mouvement de 0,3...3m/s (1...10km/h)

Matériau: matériau plastique

Kanlux ROLF JQ è un sensore del movimento a microonde. Il suo angolo orizzontale d'esercizio è di 360 gradi. È possibile regolare sia il tempo di illuminazione che il livello di illuminamento esterno a cui il sensore funziona.

- portata massima di rilevamento del movimento di 8 m
- angolo orizzontale massimo del sensore di movimento di 360°
- angolo verticale massimo del sensore di movimento di 160°
- possibilità di regolazione del tempo di accensione tra 5 s. e 12 minuti
- possibilità di regolare l'intensità della luce ambientale in cui opera il dispositivo
- campo di regolazione della sensibilità 2... 2000lx
- rilevamento del movimento di 0,3... 3 m/s (1... 10 km/h)

Materiale: plastica

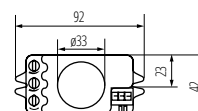
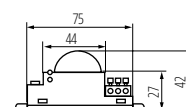
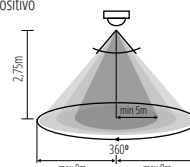

ROLF JQ-L



ROLF JQ-L	08820	5905339088208	1200	mural, saillie, montage sol montaggio a parete, montaggio a soffitto, montaggio a parete/soffitto	H360/V160	5-12	Hyperfréquence a microonde
-----------	--------------	---------------	------	---	-----------	------	---------------------------------

[V]	[Hz]	IP	□	max 8	2-2000	5+25	1+2,5	CE	EAC	UK	↻
220-240 AC	50	20									

Kanlux ROLF JQ

DÉTECTEUR DE MOUVEMENT HF ► SENSORE DI MOVIMENTO MW



ROLF MINI JQ-L

Kanlux ROLF JQ est un capteur de mouvement à micro-ondes. L'angle horizontal maximal de fonctionnement du capteur est de 360 degrés. Il est possible de régler le temps d'éclairage ainsi que le niveau d'intensité lumineuse avec laquelle le capteur fonctionne.

- portée maximale de détection de mouvement de 10 m
- angle horizontal maximal du capteur de mouvement de 360°
- angle vertical maximal du capteur de mouvement de 140°
- possibilité de régulation de temps d'éclairage de 10 s. à 30 min.
- possibilité de régler l'intensité de la lumière ambiante à laquelle l'appareil fonctionne
- plage de réglage de la sensibilité 2...2000lx
- détection de mouvement de 0,3...3m/s (1...10km/h)

Matériau: matériau plastique

Kanlux ROLF JQ è un sensore del movimento a microonde. Il suo angolo orizzontale d'esercizio è di 360 gradi. È possibile regolare sia il tempo di illuminazione che il livello di illuminamento esterno a cui il sensore funziona.

- portata massima di rilevamento del movimento di 10 m
- angolo orizzontale massimo del sensore di movimento di 360°
- angolo verticale massimo del sensore di movimento di 140°
- possibilità di regolazione del tempo di accensione tra 10s. e 30 minuti
- possibilità di regolare l'intensità della luce ambientale in cui opera il dispositivo
- campo di regolazione della sensibilità 2... 2000lx
- rilevamento del movimento di 0,3... 3 m/s (1... 10 km/h)

Materiale: plastica

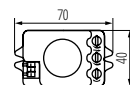
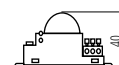
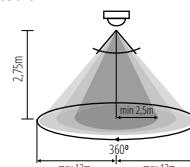

ROLF MINI JQ-L



ROLF MINI JQ-L	08822	5905339088222	1200	mural, saillie, montage sol montaggio a parete, montaggio a soffitto, montaggio a parete/soffitto	H360/V140	10-30	Hyperfréquence a microonde
----------------	--------------	---------------	------	---	-----------	-------	---------------------------------

[V]	[Hz]	IP	□	max 10	2-2000	5+25	1+2,5	CE	EAC	UK	↻
220-240 AC	50	20									

Kanlux

MERGE JQ

DÉTECTEUR DE MOUVEMENT PIR ► SENSORE DI MOVIMENTO PIR



MERGE JQ-O

Kanlux MERGE JQ est un détecteur de mouvement dont la portée maximale est de 5 mètres. L'angle horizontal de fonctionnement du détecteur est de 360 degrés. Vous pouvez régler la durée d'éclairage et le niveau d'intensité lumineuse à laquelle le détecteur fonctionne.

- portée maximale de détection de mouvement de 5 m
- angle horizontal maximal du capteur de mouvement de 360°
- angle vertical maximal du capteur de mouvement de 120°
- possibilité de régulation de temps d'éclairage de 5 s. à 6 min.
- possibilité de régler l'intensité de la lumière ambiante à laquelle l'appareil fonctionne
- charge résistive allant jusqu'à 2000W, charge d'impédance allant jusqu'à 800W
- Matériau: matériau plastique

Kanlux MERGE JQ - O è il sensore di movimento con un campo massimo di rilevamento del movimento pari a 5 metri. Il suo angolo orizzontale d'esercizio è di 360 gradi. È possibile regolare sia il tempo di illuminazione che il livello di illuminamento esterno a cui il sensore funziona.

- portata massima di rilevamento del movimento di 5m
- angolo orizzontale massimo del sensore di movimento di 360°
- angolo verticale massimo del sensore di movimento di 120°
- possibilità di regolazione del tempo di accensione tra 5s. e 6 minuti
- possibilità di regolare l'intensità della luce ambientale in cui opera il dispositivo
- carico resistivo fino a 2000 W, carico di impedenza fino a 800 W
- Materiale: plastica

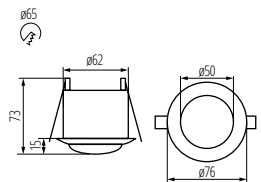
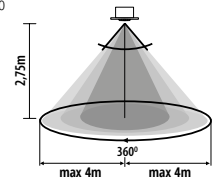

MERGE JQ-O



MERGE JQ-O | 07691 | 5905339076915 | 2000 | à encastrer dans le plafond | per montaggio a incasso nel soffitto | H360/V120 | 5-6 | PIR

[V]	[Hz]	IP	□	□	[m]	[lx]	[°C]	CE	ERC	UK	↻
220-240 AC	50	20			max 5	3-2000	5+25				

Kanlux

ROLF JQ

DÉTECTEUR DE MOUVEMENT HF ► SENSORE DI MOVIMENTO MW



ROLF JQ-O

Kanlux ROLF JQ est un capteur de mouvement à micro-ondes. L'angle horizontal maximal de fonctionnement du capteur est de 360 degrés. Il est possible de régler le temps d'éclairage ainsi que le niveau d'intensité lumineuse avec laquelle le capteur fonctionne.

- portée maximale de détection de mouvement de 9 m
- angle horizontal maximal du capteur de mouvement de 360°
- angle vertical maximal du capteur de mouvement de 160°
- possibilité de régulation de temps d'éclairage de 6 s. à 12 min.
- possibilité de régler l'intensité de la lumière ambiante à laquelle l'appareil fonctionne
- plage de réglage de la sensibilité 2...2000lx
- détection de mouvement de 0,3...3m/s (1...10km/h)
- Matériau: matériau plastique

Kanlux ROLF JQ è un sensore del movimento a microonde. Il suo angolo orizzontale d'esercizio è di 360 gradi. È possibile regolare sia il tempo di illuminazione che il livello di illuminamento esterno a cui il sensore funziona.

- portata massima di rilevamento del movimento di 9 m
- angolo orizzontale massimo del sensore di movimento di 360°
- angolo di funzionamento verticale massimo del sensore di movimento di 160°
- possibilità di regolazione del tempo di accensione tra 6 s. e 10 minuti
- possibilità di regolare l'intensità della luce ambientale in cui opera il dispositivo
- campo di regolazione della sensibilità 2... 2000lx
- rilevamento del movimento 0,3-(1...10km/h)
- Materiale: plastica

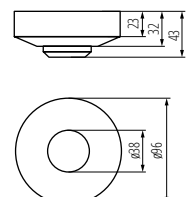
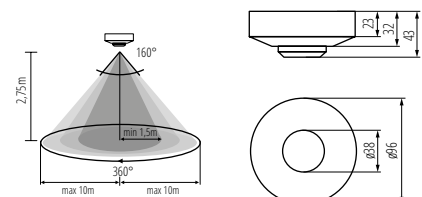

ROLF JQ-O



ROLF JQ-O | 08821 | 5905339088215 | 1200 | saillie | montage a soffitto | H360/V160 | 6-12 | Hyperfréquence | a microonde

[V]	[Hz]	IP	□	□	[m]	[lx]	[°C]	[mm]	CE	ERC	UK	↻
220-240 AC	50	20			max 9	2-2000	5+25	0,75+1,5				

Kanlux MERGE

DÉTECTEUR DE MOUVEMENT PIR ► SENSORE DI MOVIMENTO PIR



MERGE ADJ-O



Kanlux MERGE ADJ est un détecteur de mouvement infra-rouge qui détecte sur une portée maximum de 5m. En outre, il détecte sur 360°. Les paramètres de réglage du détecteur MERGE ADJ sont facilement accessibles et ne nécessitent pas de démontage.

portée maximale de détection de mouvement de 5 m
angle horizontal maximal du capteur de mouvement de 360°
possibilité de régulation de temps d'éclairage de 10 s. à 15 min.
possibilité de régler l'intensité de la lumière ambiante à laquelle l'appareil fonctionne
détection de mouvement de 0,6-1,5m/s
angle vertical maximal du capteur de mouvement de 120°
Matériau: matériau plastique

Kanlux MERGE ADJ è il sensore di movimento PIR con un campo massimo di rilevamento del movimento di 5m. Il suo angolo orizzontale massimo d'esercizio è di 360 gradi. Il sensore MERGE ADJ consente di regolare le impostazioni dei parametri senza doverlo smontare.

portata massima di rilevamento del movimento di 5 m
angolo orizzontale massimo del sensore di movimento di 360 °
possibilità di regolazione del tempo di accensione tra 10 s. e 15 minuti
possibilità di regolare l'intensità della luce ambientale in cui opera il dispositivo
rilevamento del movimento 0,6-1,5 m / s
angolo verticale massimo del sensore di movimento 120 °
Materiale: plastica

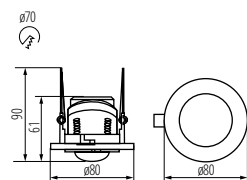
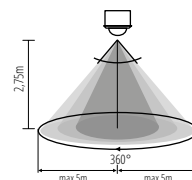

MERGE ADJ-O

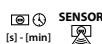

MERGE ADJ-O | 23451 | 5905339234513 | 800 | à encastrer dans le plafond | per montaggio a incasso nel soffitto | H360/V120 | 10-15 | PIR

[V]	[Hz]	IP	max 5	3-2000	5+25	0,75+1,5	CE	EAC	UK CA	↓
220-240 AC	50	20								

Kanlux MERGE

DÉTECTEUR DE MOUVEMENT HF ► SENSORE DI MOVIMENTO MW



MERGE MW-L



Le capteur Kanlux MERGE MW offre une solution esthétique et pratique. Sa portée maximale de détection de mouvement est de 9 m. Il est possible de régler le temps d'éclairage ainsi que le niveau d'intensité lumineuse avec laquelle le capteur fonctionne.

portée maximale de détection de mouvement de 9 m
angle horizontal maximal du capteur de mouvement de 180°
possibilité de régulation de temps d'éclairage de 10 s. à 12 min.
possibilité de régler l'intensité de la lumière ambiante à laquelle l'appareil fonctionne
détection de mouvement de 0,6-1,5m/s
angle vertical maximal du capteur de mouvement de 180°
Matériau: matériau plastique

Il sensore Kanlux MERGE MW è una soluzione estetica e funzionale. Il campo di rilevamento massimo del movimento è pari a 9 metri. È possibile regolare sia il tempo di illuminazione che il livello di illuminamento esterno a cui il sensore funziona.

portata massima di rilevamento del movimento di 9 m
angolo orizzontale massimo del sensore di movimento di 180 °
possibilità di regolazione del tempo di accensione tra 10 s. e 17 minuti
possibilità di regolare l'intensità della luce ambientale in cui opera il dispositivo
rilevamento del movimento 0,6-1,5 m / s
angolo verticale massimo del sensore di movimento 180 °
Materiale: plastica

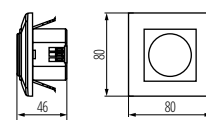
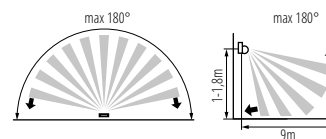

MERGE MW-L

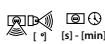

MERGE MW-L | 23453 | 5905339234537 | 1200 | encastré dans le mur | per montaggio a incasso nella parete | 180 | 10-12 | Hyperfréquence | a microonde

[V]	[Hz]	IP	max 9	3-2000	5+25	0,75+1,5	CE	EAC	UK CA	↓
220-240 AC	50	20								

Kanlux SENTO

DÉTECTEUR DE MOUVEMENT PIR / CAPTEUR DE MOUVEMENT ► SENSORE DI MOVIMENTO PIR



SENTO



Kanlux SENTO est un capteur électronique pour la détection de mouvement. Sa particularité réside dans le fait que jusqu'à trois détecteurs infrarouges sont installés dans un seul détecteur. Ceci garantit une sensibilité sans précédent et vous permet de capter le moindre mouvement. Kanlux SENTO, en raison de ses caractéristiques inhabituelles, assure à la fois une fonction de détecteur de présence et capteur mouvement.

Matériau: matériau plastique

Kanlux SENTO è un sensore elettronico per il rilevamento del movimento. La sua unicità sta nel fatto che in un solo rivelatore ne sono installati ben tre a infrarossi. Questo garantisce una sensibilità senza precedenti e permette di catturare anche il minimo movimento. Kanlux SENTO, per le sue caratteristiche inusuali, viene chiamato rivelatore di presenza.

Materiale: plastica

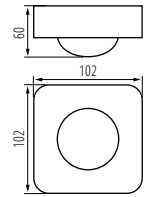
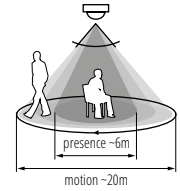
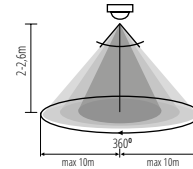

SENTO



SENTO | 26820 | 5905339268204 | 2000 | mural, saillie | montaggio a parete, montaggio a soffitto | H360/V120 | 10-30 | 3xPIR

[V]	[Hz]	IP	House icon	max 10	3-2000	5+25	0,75+1,5	CE	ERC	UK	Down arrow icon
220-240 AC	50	20									

Kanlux SENZO

DÉTECTEUR DE MOUVEMENT PIR ► SENSORE DI MOVIMENTO PIR



SENZO



Kanlux SENZO est un détecteur de mouvement PIR utilisé dans les systèmes de commutation d'éclairage automatique. La disposition spéciale de deux capteurs infrarouges à Kanlux SENZO permet de l'utiliser dans des installations en hauteur, telles que des entrepôts ou des halls de production. Sa portée verticale peut atteindre 10 mètres.

Matériau: matériau plastique

Kanlux SENZO è un rivelatore di movimento PIR utilizzato nei sistemi di commutazione automatica dell'illuminazione. Una speciale disposizione di due sensori a infrarossi in Kanlux SENZO ne consente l'impiego in ambienti con altezze elevate, come magazzini o capannoni di produzione. La sua portata verticale arriva fino a 10 metri.

Materiale: plastica

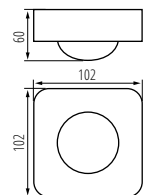
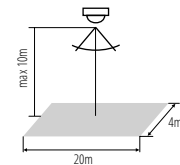

SENZO



SENZO | 26821 | 5905339268211 | 2000 | mural, saillie | montaggio a parete, montaggio a soffitto | H360/V120 | 10-30 | 2xPIR

[V]	[Hz]	IP	House icon	max 10	3-2000	5+25	0,75+1,5	CE	ERC	UK	Down arrow icon
220-240 AC	50	20									



Kanlux AZ-10A

RELAIS CRÉPUSCULAIRE ► RELÈ CREPUSCOLO



AZ-10A



AZ-10A | 22371 | 5905339223715 | blanc | bianco | mural | montaggio a parete

[V]	[Hz]	In[A]	[VA]	°C	□	🏠	IP	CE	EAC	UK	♻️
220-240 AC	50	10	2300	-20+40			20/65				

Kanlux AS-10 est un détecteur crépusculaire. Il sert à allumer et éteindre les circuits d'alimentation du dispositif l'éclairage ou d'autres récepteurs électriques, en fonction du niveau d'intensité de la lumière naturelle (jour/nuit).

Hystérèse -20Lx

Kanlux AZ-10A è un interruttore crepuscolare. È progettato per attivare e disattivare i circuiti di illuminazione o di altri apparecchi elettrici a seconda del livello di luce naturale (giorno/notte).

Isteresi - 20Lx

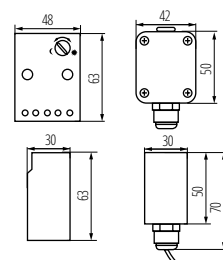

AZ-10A

Kanlux CYBER

HORLOGE/PROGRAMMATEUR ► TIMER/PROGRAMMATORE DI COMANDO



CYBER TM-6



CYBER TM-6 | 01016 | 5905339010162 | 3600 | 10

[V]	[Hz]	In[A]	IP	⏚	⚡	CE	ERC	UK	⌚
220-240 AC	50	16(2)	20						

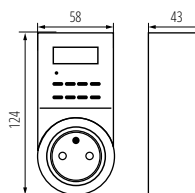

CYBER TM-6

Kanlux CYBER est un adaptateur pour prise électrique avec un programmateur numérique. Il permet de programmer l'allumage et l'extinction des appareils connectés à des moments déterminés.

équipé d'un système maintenant la mémoire
possibilité de programmer jusqu'à 10 cycles marche/arrêt
le programmeur travaille en modes quotidien et hebdomadaire

Kanlux CYBER è un adattatore per presa elettrica con programmatore digitale giornaliero. Consente di programmare l'attivazione e la disattivazione dei dispositivi collegati per un determinato periodo di tempo.

dotato di un sistema di mantenimento della memoria
possibilità di programmare fino a 10 cicli on/off
il programmatore funziona in modalità giornaliera e settimanale

Kanlux STER TS-MF

HORLOGE/PROGRAMMATEUR ► TIMER/PROGRAMMATORE DI COMANDO



STER TS-MF-1



STER TS-MF1 | 01001 | 5905339010018 | 3500 | 1

[V]	[Hz]	In[A]	IP	⏚	⚡	CE	ERC	UK	⌚
220-240 AC	50	16(2)	20						

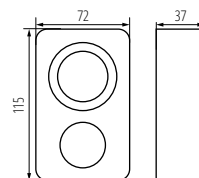

STER TS-MF-1

Kanlux STER TS-MF est un adaptateur pour prise électrique avec un programmateur mécanique journalier. Il permet de programmer l'allumage et l'extinction des appareils connectés à des moments déterminés.

programmateur fonctionne en mode quotidien
temps minimum nécessaire marche/arrêt de 15 min
le programmeur dispose d'une fonction d'une commutation de charge constante

Kanlux STER TS-MF è un adattatore per presa elettrica con programmatore meccanico giornaliero. Consente di programmare l'attivazione e la disattivazione dei dispositivi collegati per un determinato periodo di tempo.

il timer funziona in modalità giornaliera
tempo minimo richiesto on/off 15 min
il programmatore ha una funzione di commutazione del carico costante

Kanlux ADI

ALIMENTATION CC ► ALIMENTATORE CC



ADI 350 1x3W



ADI 350 1x3W | 01440 | 5905339014405 | 350 | 1-3

[V]	[Hz]	CC	PRI [V]	SEC [V]	F	IP	House	□
220-240 AC	50		220-240	0,5-10 DC		20		
	[mm]	[m]	°C	CE	ERC	UK	CA	Recycle
	0,75	0,1	5+25					

Le bloc d'alimentation électronique Kanlux ADI, avec une température maximale admissible du boîtier de 75°C et la stabilisation du courant 350mA DC, est doté d'une protection contre les courts-circuits et contre les surcharges, ainsi qu'une protection thermique qui arrête le bloc d'alimentation après que la température dépasse les 110°C.

ADI 350 1-3W stabilisation de courant 350mA DC

température maximale admissible du boîtier de 75°C

protection thermique désactivant l'adaptateur d'alimentation lorsque la température dépasse 110°C

protections contre les surcharges et les courts-circuits intégrées

L'alimentation n'est pas conçue pour fonctionner sans charge.

Matériau: matériau plastique

L'alimentatore elettronico Kanlux ADI, con una temperatura massima ammissibile della cover di 75°C e una stabilizzazione della corrente di 350mA DC, è dotato di una protezione incorporata contro i cortocircuiti e il sovraccarico e di una protezione termica che interrompe l'alimentazione quando la temperatura supera i 110°C.

ADI 350 1-3W stabilizzazione corrente 350mA DC

temperatura massima consentita dell'alloggiamento di 75°C

protezione termica che interrompe l'alimentazione quando la temperatura supera i 110°C

protezione integrata da cortocircuito e sovraccarico

L'alimentatore non è progettato per funzionare senza tensione

Materiale: plastica

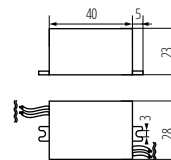

ADI 350 1x3W

Kanlux POWELED

ALIMENTATION CV ► ALIMENTATORE CV



POWELED P 12V 30W

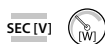

POWELED P 12V 30W	26810	5905339268105	12 DC	1-30
POWELED P 12V 60W	26811	5905339268112	12 DC	1-60
POWELED P 24V 30W	26815	5905339268150	24 DC	1-30
POWELED P 24V 60W	26816	5905339268167	24 DC	1-60
POWELED P 12V 100W	28961	5905339289612	12 DC	1-100
POWELED P 24V 100W	28962	5905339289629	24 DC	1-100
POWELED P 12V 150W	28963	5905339289636	12 DC	75-150
POWELED P 24V 150W	28964	5905339289643	24 DC	75-150
POWELED P 12V 200W	28965	5905339289650	12 DC	120-200
POWELED P 24V 200W	28966	5905339289667	24 DC	120-200

[V]	[Hz]	CV	PRI [V]	F	IP	House	□
220-240 AC	50		220-240		20		
	[mm]	°C	CE	ERC	UK	CA	Recycle
	0,5-1,5	5+25					

Kanlux TRETO est un alimentateur électronique à courant continu d'une puissance. Elle est utilisée pour alimenter des rubans à LED tels que LED S P ou LED S B.

L'alimentation n'est pas conçue pour fonctionner sans charge.

Matériau: matériau plastique

Kanlux POWELED è un alimentatore elettronico a tensione costante. Viene utilizzato per alimentare strisce LED come LED P o LED B.

L'alimentatore non è progettato per funzionare senza tensione.

Materiale: plastica

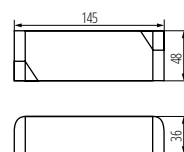

POWELED P 30W

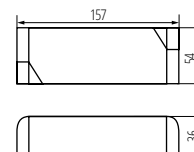

POWELED P 60W

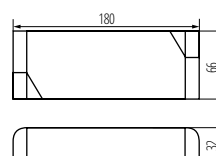

POWELED P 100W

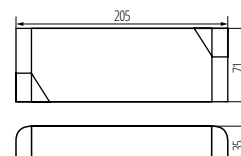

POWELED P 150W / POWELED P 200W

Kanlux CIRCO

ALIMENTATION CV ► ALIMENTATORE CV



CIRCO LED 12VDC



CIRCO LED 12VDC 0-10W	24240	5905339242402	12 DC	0-10
CIRCO LED 12VDC 0-15W	24241	5905339242419	12 DC	0-15

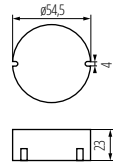

CIRCO LED 12VDC

Kanlux DRIVE LED

ALIMENTATION CV ► ALIMENTATORE CV



DRIVE LED N 15W 12V



DRIVE LED N 15W 12V	23861	5905339238610	220-240 AC	max 15
---------------------	--------------	---------------	------------	--------

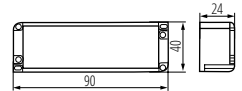

DRIVE LED N 15W 12V

Kanlux SET

TRANSFORMATEUR ÉLECTRONIQUE SET ► TRASFORMATORE ELETTRONICO SET



SET60-K

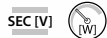

SET60-K	01425	5905339014252	11,5 AC	20-60
SET105-K	01426	5905339014269	11,5 AC	35-105

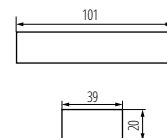

SET60-K

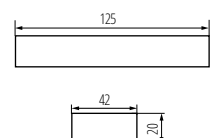

SET105-K

Kanlux CIRCO est un alimentateur électronique à courant continu d'une puissance de 10 ou bien 15 W. Elle est utilisée pour alimenter des rubans à LED tels que LED S P ou LED S B.

L'alimentation n'est pas conçue pour fonctionner sans charge.

Kanlux CIRCO è un alimentatore elettronico a corrente continua con una potenza di 10 o 15 W. Viene utilizzato per alimentare strisce LED, come LED P o LED B.

L'alimentatore non è progettato per funzionare senza tensione.



L'alimentation n'est pas conçue pour fonctionner sans charge.

Matériau: matériau plastique

L'alimentatore non è progettato per funzionare senza tensione

Materiale: plastica

produit destiné à alimenter les ampoules halogènes basse tension (12V)

facteur de puissance réactive $\cos\phi$ pour SET60-K et SET105-K de 0,99, pour SET80LT, SET150-N et SET210-N de 0,97

température maximale admissible du boîtier pour SET60-K de 80°C, pour les autres modèles de 85°C

protection thermique désactivant le modèle SET80LT lorsque la température dépasse 100°C, les modèles SET150-N et SET210-N lorsque la température dépasse 110°C, les modèles SET60-K et SET105-K lorsque la température dépasse 120°C

protections contre les surcharges et les courts-circuits intégrées

L'alimentation n'est pas conçue pour fonctionner sans charge.

prodotto destinato ad alimentare lampade alogene a bassa tensione (12V)

fattore di potenza reattiva $\cos\phi$ per SET 60-K e SET 105-K di 0,99, per SET 80LT, SET 150-N e SET 210-N di 0,97

temperatura massima ammissibile della custodia per SET 60-K 80°C, per altri modelli 85°C

protezione termica disattivando il modello SET 80LT quando la temperatura supera i 100°C, i modelli SET 150-N e SET 210-N quando la temperatura supera i 110°C, i modelli SET 60-K e SET 105-K quando la temperatura supera i 120 ° C

protezioni integrate da sovraccarico e cortocircuito

L'alimentatore non è progettato per funzionare senza tensione.

Kanlux

WIR ZL

EXTRACTEUR D'AIR ► ASPIRATORE



WIR ZL100



WIR ZL120



WIR ZL100	70961	8594056490349	blanc bianco
WIR ZL120	70962	8594056490356	blanc bianco

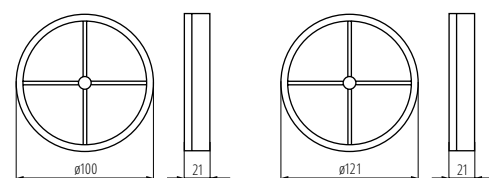

WIR ZL100

WIR ZL120

Kanlux

TWISTER

EXTRACTEUR D'AIR ► ASPIRATORE



TWISTER AOL100B

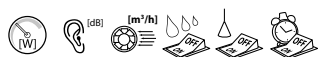

TWISTER AOL100B	70926	8594056490172	19	42	100	
TWISTER AOL100T	70953	8594056490202	19	42	100	oui si
TWISTER AOL120B	70956	8594056490226	20	42	150	
TWISTER AOL120T	70960	8594056490257	20	42	150	oui si

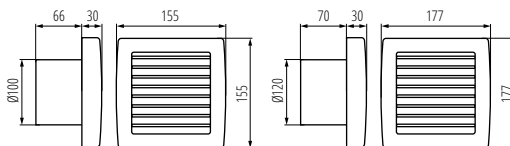

TWISTER AOL100

TWISTER AOL120



La gamme d'extracteurs d'aire Kanlux TWISTER AOL est disponible en deux tailles, avec un diamètre de 100 et 120 mm. Ils sont fabriqués en plastique blanc. Leur puissance est de 19 et 20 W respectivement. Le nombre de rotations de chaque taille est de 2550/min.

È disponibile la serie di ventilatori Kanlux TWISTER AOL in due misure con diametro 100 e 120 mm. Sono realizzati in plastica, di colore bianco. I loro potenza è rispettivamente di 19 e 20 W. Il numero di rotazioni da ogni taglia arriva a 2550/min.



CYKLON EOL100



CYKLON EOL120



CYKLON EOL150

La gamme d'extracteurs d'aire Kanlux CYKLON EOL est disponible en trois dimensions de diamètre: 100, 120 et 150 mm. Ils sont fabriqués en matière plastique de couleur blanche. Ils sont disponibles en variantes de 19, 20 et 22 W de puissance. Le régime de rotation de chaque modèle est de 2550 par minute.

nombre de tours de 2550/min

La serie di ventilatori Kanlux CYKLON EOL è disponibile in tre misure di diametro diverse: da 100, 120 e 150 mm. Sono realizzati in plastica bianca. La loro potenza è rispettivamente di 19, 20 e 22W. Il numero di giri per ogni tipo è di 2550 giri/min.

numero di giri di 2550 / min

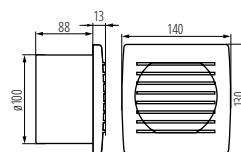

CYKLON EOL100

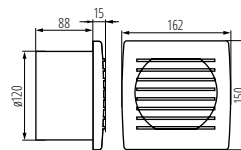

CYKLON EOL120

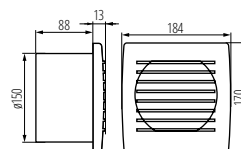

CYKLON EOL150



CYKLON EOL100	70910	8594056490011	19	38	100	oui si	câble avec fiche cavo con una spina (terminale)	
CYKLON EOL100B	70911	8594056490028	19	38	100		Connecteur de raccordement morsetti	
CYKLON EOL120	70915	8594056490066	20	38	150	oui si	câble avec fiche cavo con una spina (terminale)	
CYKLON EOL120B	70916	8594056490073	20	38	150		Connecteur de raccordement morsetti	
CYKLON EOL150	70920	8594056490110	22	38	200	oui si	câble avec fiche cavo con una spina (terminale)	
CYKLON EOL150B	70921	8594056490127	22	38	200		Connecteur de raccordement morsetti	
CYKLON EOL100HT	70936	8594056490035	19	38	100	oui si	oui si	Connecteur de raccordement morsetti
CYKLON EOL100P	70937	8594056490370	19	38	100	oui si		Connecteur de raccordement morsetti
CYKLON EOL100T	70938	8594056490059	19	38	100		oui si	Connecteur de raccordement morsetti
CYKLON EOL120HT	70941	8594056490080	20	38	150	oui si	oui si	Connecteur de raccordement morsetti
CYKLON EOL120P	70942	8594056490387	20	38	150	oui si		Connecteur de raccordement morsetti
CYKLON EOL120T	70943	8594056490103	20	38	150		oui si	Connecteur de raccordement morsetti
CYKLON EOL150P	70947	8594056490394	22	38	200	oui si		Connecteur de raccordement morsetti
CYKLON EOL150T	70948	8594056490158	22	38	200	oui si		Connecteur de raccordement morsetti



Kanlux GRIP

MULTIPRISES, PRISES, FICHES ► SPLITTER, PRESE, SPINE



GRIP GP/S

GRIP W/US



GRIP GP/S	04862	5905339048622	noir nero
GRIP W/US	04863	5905339048639	noir nero

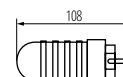
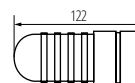

GRIP GP/S

GRIP W/US

[V] 250 AC	[Hz] 50		In[A] 16	IP 44			
----------------------	-------------------	--	--------------------	-----------------	--	--	--

STAN GP possède la première classe de protection contre les chocs électriques
GRIP GP/S équipé d'une mise à terre de type Schuko
Matériau: matériau plastique
presa di corrente per prolunga.
STAN GP ha la 1a classe di protezione contro le scosse elettriche
GRIP GP/S dotato di messa a terra Schuko
Materiale: plastica

Kanlux PIN W/US

MULTIPRISES, PRISES, FICHES ► SPLITTER, PRESE, SPINE



PIN W/US



PIN W/US	02186	5905339021861	blanc bianco
----------	--------------	---------------	----------------

[V] 250 AC	[Hz] 50			In[A] 16	IP 20			
----------------------	-------------------	--	--	--------------------	-----------------	--	--	--

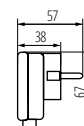

PIN W/US

Kanlux STAN GP

MULTIPRISES, PRISES, FICHES STAN GP ► DISTRIBUTORI, PRESE, SPINE STAN GP



STAN GP



STAN GP	04864	5905339048646	noir nero
---------	--------------	---------------	-------------

[V] 250 AC	[Hz] 50		In[A] 16	IP 44			
----------------------	-------------------	--	--------------------	-----------------	--	--	--

Matériau: matériau plastique
Materiale: plastica

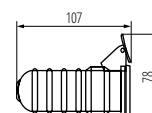

STAN GP

Kanlux ZARK

MULTIPRISES, PRISES, FICHES ► SPLITTER, PRESE, SPINE



ZARK KRT/2-1



ZARK KRT/2-1	02180	5905339021809	blanc bianco
ZARK KRW-3	02181	5905339021816	blanc bianco

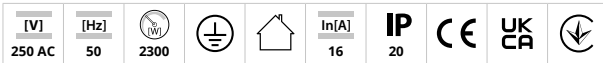

Vous manquez d'espace pour brancher au courant un autre appareil ? Rien de plus facile : les répartiteurs ZARK résoudreont votre problème. Vous bénéficierez de trois nouvelles prises de contact.

Équipé d'un contact de protection

Matériau: matériau plastique

Ti manca lo spazio per collegare un ulteriore dispositivo alla presa? Non c'è niente di più facile delle prese multiple ZARK che subito risolvono il problema. In questo modo otterrai tre nuove prese di corrente.

Materiale: plastica

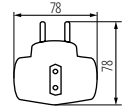

ZARK KRT/2-1

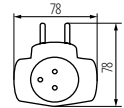

ZARK KRW-3

Kanlux APO

HORLOGE/PROGRAMMATEUR ► TIMER/PROGRAMMATORE DI COMANDO



APO TM-3



APO TM-3	07980	5905339079800	1150	5
----------	--------------	---------------	------	---



Kanlux APO est un ensemble de 3 adaptateurs de prises de courant avec la possibilité de commande à distance à l'aide d'une télécommande. Chaque appareil connecté peut être allumé indépendamment des autres.

Inclus : 3 fiches, télécommande, batterie

Avec une impédance de charge, la charge maximale est de 1150W

Les fiches peuvent être installées côte à côte à une distance d'au moins 0,5 m

La diode signale le travail de la prise électrique

La plage de fonctionnement de la télécommande est de 25 m (do 50 m dans un espace ouvert)

Kanlux APO è un set di 3 adattatori per presa elettrica con possibilità di controllo remoto tramite telecomando. Ogni dispositivo collegato può essere attivato indipendentemente dagli altri.

Include: 3 spine, telecomando, batteria

Batteria con impedenza di carico, il carico massimo è 1150W

I tasselli possono essere installati affiancati ad una distanza di almeno 0,5 m

Il diodo segnala il lavoro della presa elettrica

Il raggio d'azione del telecomando è di 25 m (fare 50 m in uno spazio aperto)

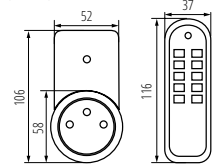

APO TM-3

Kanlux BR-GZ10

DOUILLE AVEC SUPPORT ► PORTALAMPADA



BR-GZ10



BR-GZ10	72369	5905339723697	gris grigio
---------	--------------	---------------	---------------



température maximale admissible de la douille pour BR-GZ10, HLDR-GZ10, HLDR-R75 de 250°C, pour les autres modèles de 180°C

courant maximal admissible pour BR-GZ10, HLDR-GZ10, HLDR-G9 de 2A, pour HLDR-R75 de 6A, pour HLDR-GX5.3 de 5A

BR-GZ10 équipé d'un support

temperatura massima ammissibile presa per BR-GZ 10, HLDR -GZ 10, HLDR -R75 da 250°C, per altri modelli 180°C

corrente massima ammissibile per BR -GZ 10, HLDR -GZ 10, HLDR -G9 di 2A, per HLDR -R75 di 6A, per HLDR -GX 5.3 di 5A

BR -GZ 10 dotato di supporto

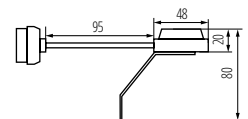

BR-GZ10

Kanlux

HLDR-E14

DOUILLE ► PORTALAMPADA



HLDR-E14



HLDR-E14 | 02170 | 5905339021700 | gris | grigio

[V] 250 AC	[Hz] 50	In[A] 2	E14	IP 00				
----------------------	-------------------	-------------------	------------	-----------------	--	--	--	--

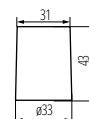

HLDR-E14

température maximale admissible de la douille de 180°C

temperatura massima consentita della presa di 180°C

Kanlux

HLDR-E14

DOUILLE ► PORTALAMPADA



HLDR-E14-F



HLDR-E14-F | 02173 | 5905339021731 | gris | grigio

[V] 250 AC	[Hz] 50	In[A] 2	E14	IP 00				
----------------------	-------------------	-------------------	------------	-----------------	--	--	--	--



température maximale admissible de la douille de 180°C

temperatura massima consentita della presa di 180°C

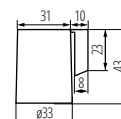

HLDR-E14-F

Kanlux

HLDR-E27

DOUILLE ► PORTALAMPADA



HLDR-E27



HLDR-E27 | 02160 | 5905339021601 | gris | grigio

[V] 250 AC	[Hz] 50	In[A] 4	E27	IP 00				
----------------------	-------------------	-------------------	------------	-----------------	--	--	--	--



température maximale admissible de la douille de 180°C

temperatura massima consentita della presa di 180°C

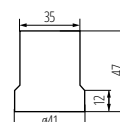

HLDR-E27

Kanlux

HLDR-E27

DOUILLE ► PORTALAMPADA



HLDR-E27-D



HLDR-E27-D | 02162 | 5905339021625 gris | grigio

[V] 250 AC	[Hz] 50	In[A] 4	E27	IP 00				
----------------------	-------------------	-------------------	------------	-----------------	--	--	--	--



température maximale admissible de la douille de 180°C

temperatura massima consentita della presa di 180°C

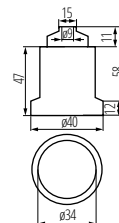

HLDR-E27-D

Kanlux

HLDR-E27

DOUILLE ► PORTALAMPADA



HLDR-E27-F



HLDR-E27-F | 02161 | 5905339021618 gris | grigio

[V] 250 AC	[Hz] 50	In[A] 4	E27	IP 00				
----------------------	-------------------	-------------------	------------	-----------------	--	--	--	--



température maximale admissible de la douille de 180°C

temperatura massima consentita della presa di 180°C

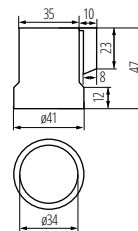

HLDR-E27-F

Kanlux

HLDR-G9

DOUILLE ► PORTALAMPADA



HLDR-G9



HLDR-G9 | 08220 | 5905339082206 gris | grigio

[V] 250 AC	In[A] 2	G9	IP 00				
----------------------	-------------------	-----------	-----------------	--	--	--	--



température maximale admissible de la douille pour BR-GZ10, HLDR-GZ10, HLDR-R7S de 250°C, pour les autres modèles de 180°C

courant maximal admissible pour BR-GZ10, HLDR-GZ10, HLDR-G9 de 2A, pour HLDR-R7S de 6A, pour HLDR-GX5.3 de 5A

BR-GZ10 équipé d'un support

temperatura massima ammissibile presa per BR -GZ 10, HLDR -GZ 10, HLDR -R7S da 250°C, per altri modelli 180°C

corrente massima ammissibile per BR -GZ 10, HLDR -GZ 10, HLDR -G9 di 2A, per HLDR -R7S di 6A, per HLDR -GX 5.3 di 5A

BR -GZ 10 dotato di supporto

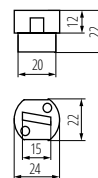

HLDR-G9

Kanlux

HLDR-GX5.3

DOUILLE ► PORTALAMPADA



HLDR-GX5.3



HLDR-GX5,3 | **72109** | 5905339721099 | gris | grigio

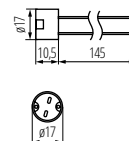

HLDR-GX5.3

Kanlux

HLDR-GZ10

DOUILLE ► PORTALAMPADA



HLDR-GZ10



HLDR-GZ10 | **00402** | 5905339004024 | gris | grigio

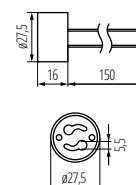

HLDR-GZ10

Kanlux

HLDR-R7S

DOUILLE ► PORTALAMPADA



HLDR-R7S



HLDR-R7S | **00405** | 5905339004055 | gris | grigio

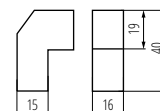

HLDR-R7S

température maximale admissible de la douille pour BR-GZ10, HLDR-GZ10, HLDR-R7S de 250°C, pour les autres modèles de 180°C

courant maximal admissible pour BR-GZ10, HLDR-GZ10, HLDR-G9 de 2A, pour HLDR-R7S de 6A, pour HLDR-GX5.3 de 5A

BR-GZ10 équipé d'un support

temperatura massima ammissibile presa per BR -GZ 10, HLDR -GZ 10, HLDR -R7S da 250°C, per altri modelli 180°C

corrente massima ammissibile per BR -GZ 10, HLDR -GZ 10, HLDR -G9 di 2A, per HLDR -R7S di 6A, per HLDR -GX 5.3 di 5A

BR -GZ 10 dotato di supporto

température maximale admissible de la douille pour BR-GZ10, HLDR-GZ10, HLDR-R7S de 250°C, pour les autres modèles de 180°C

courant maximal admissible pour BR-GZ10, HLDR-GZ10, HLDR-G9 de 2A, pour HLDR-R7S de 6A, pour HLDR-GX5.3 de 5A

BR-GZ10 équipé d'un support

temperatura massima ammissibile presa per BR -GZ 10, HLDR -GZ 10, HLDR -R7S da 250°C, per altri modelli 180°C

corrente massima ammissibile per BR -GZ 10, HLDR -GZ 10, HLDR -G9 di 2A, per HLDR -R7S di 6A, per HLDR -GX 5.3 di 5A

BR -GZ 10 dotato di supporto

température maximale admissible de la douille pour BR-GZ10, HLDR-GZ10, HLDR-R7S de 250°C, pour les autres modèles de 180°C

courant maximal admissible pour BR-GZ10, HLDR-GZ10, HLDR-G9 de 2A, pour HLDR-R7S de 6A, pour HLDR-GX5.3 de 5A

BR-GZ10 équipé d'un support

temperatura massima ammissibile presa per BR -GZ 10, HLDR -GZ 10, HLDR -R7S da 250°C, per altri modelli 180°C

corrente massima ammissibile per BR -GZ 10, HLDR -GZ 10, HLDR -G9 di 2A, per HLDR -R7S di 6A, per HLDR -GX 5.3 di 5A

BR -GZ 10 dotato di supporto

ONTEC S











BLOC DE SECOURS LED ▶ LAMPADA LED DI EMERGENZA



ONTEC S 20M1XATW



				MODE	USE	 ST	AT
ONTEC S M1180MSTW	27527	5902052525256	3,3	secours et veille interruttore automatico	éclairage anti-panique illuminazione antipanico	3	✓
ONTEC S 20M1XSTW	27528	5902052527533	3,6	secours, secours et veille di emergenza, interruttore automatico	éclairage anti-panique illuminazione antipanico	1\3	✓
ONTEC S 20M1XATW	27529	5902052527489	3,8	secours, secours et veille di emergenza, interruttore automatico	éclairage anti-panique illuminazione antipanico	1\3	✓
ONTEC S C1302MATW	27652	5902052502523	6,5	secours et veille interruttore automatico	éclairage de balisage illuminazione della via di evacuazione	3	✓
ONTEC S M1180MATW	28973	5902052521012	3,3	secours et veille interruttore automatico	éclairage anti-panique illuminazione antipanico	3	✓
ONTEC S C1302MATWCLD	28977	5902052529322	6,5	secours et veille interruttore automatico	éclairage de balisage illuminazione della via di evacuazione	3	✓
ONTEC S C160NMATW	28978	5902052538744	1,2	secours di emergenza	éclairage de balisage illuminazione della via di evacuazione	1	✓
ONTEC S W1302MATWCLD	33810	5902052529384	6,5	secours et veille interruttore automatico	éclairage de balisage illuminazione della via di evacuazione	3	✓
ONTEC S M2302MATWCLD	33818	5902052528745	6,5	secours et veille interruttore automatico	éclairage anti-panique illuminazione antipanico	3	✓
ONTEC S M2102MATWCLD	33819	5902052529261	6,5	secours et veille interruttore automatico	éclairage anti-panique illuminazione antipanico	1	✓
ONTEC S M5105MATW	33840	5902052529575	6,8	secours et veille interruttore automatico	éclairage anti-panique illuminazione antipanico	1	✓
ONTEC S M5305MATW	33841	5902052529582	6,8	secours et veille interruttore automatico	éclairage anti-panique illuminazione antipanico	3	✓
ONTEC S F2105MATW	33842	5902052531950	6,5	secours et veille interruttore automatico	éclairage de balisage illuminazione della via di evacuazione	3	✓
ONTEC S C2105MATW	33843	5902052529698	6,8	secours et veille interruttore automatico	éclairage de balisage illuminazione della via di evacuazione	1	✓
ONTEC S F2105MATW	33844	5902052529810	6,8	secours et veille interruttore automatico	éclairage de balisage illuminazione della via di evacuazione	1	✓
ONTEC S W1302MATW	33845	5902052541454	6,5	secours et veille interruttore automatico	éclairage des issues de secours, des dispositifs de protection incendie illuminazione di uscite di emergenza, dispositivo antincendio	3	✓
ONTEC S W2105MATWCLD	33846	5902052529445	6,8	secours et veille interruttore automatico	éclairage des issues de secours, des dispositifs de protection incendie illuminazione di uscite di emergenza, dispositivo antincendio	1	✓
ONTEC S M5105MSTW	33855	5902052529551	6,8	secours et veille interruttore automatico	éclairage anti-panique illuminazione antipanico	1	✓
ONTEC S M2302MSTWCLD	33856	5902052528738	6,5	secours et veille interruttore automatico	éclairage anti-panique illuminazione antipanico	3	✓
ONTEC S C1302MSTW	33862	5902052531943	6,5	secours et veille interruttore automatico	éclairage de balisage illuminazione della via di evacuazione	3	✓
ONTEC S F2105MSTW	33864	5902052529797	6,8	secours et veille interruttore automatico	éclairage de balisage illuminazione della via di evacuazione	1	✓
ONTEC S W1302MSTW	33865	5902052541447	6,5	secours et veille interruttore automatico	éclairage des issues de secours, des dispositifs de protection incendie illuminazione di uscite di emergenza, dispositivo antincendio	3	✓
ONTEC S W1302MSTWCLD	33866	5902052529377	6,5	secours et veille interruttore automatico	éclairage des issues de secours, des dispositifs de protection incendie illuminazione di uscite di emergenza, dispositivo antincendio	3	✓
ONTEC S M2302MSTW	36381	5902052528301	6,5	secours et veille interruttore automatico	éclairage anti-panique illuminazione antipanico	3	✓
ONTEC S M2302MATW	36382	5902052528318	6,5	secours et veille interruttore automatico	éclairage anti-panique illuminazione antipanico	3	✓

 220-240 AC	 50	 IP 65	 Tc (K) 5000							
--	--	---	---	---	---	---	---	---	---	---

ONTEC S

BLOC DE SECOURS LED ► LAMPADA LED DI EMERGENZA



L'éclairage de secours ou d'antipanico est utilisé pour des pièces de type open space pour prévenir la panique. Il permet d'accéder à un endroit balisé par un chemin d'évacuation ainsi que l'évacuation elle-même, selon le pictogramme du luminaire.

Matériau du boîtier: matériau plastique

Matériau du diffuseur: matériau plastique

L'illuminazione di emergenza o di antipanico viene utilizzata in ambienti di tipo "open space" per prevenire il panico. Permette di raggiungere il luogo dove è possibile vedere la via di fuga segnalata e l'evacuazione stessa, a seconda del prisma utilizzato nell'apparecchio di illuminazione.

Materiale del corpo: plastica

Diffusore: plastica



ONTEC S M1180MSTW



ONTEC S 20M1XSTW



ONTEC S 20M1XATW



ONTECSC1302MATW



ONTEC S M1180MATW



ONTEC S C1302MATWCLD



ONTEC S C160NATW



ONTEC S W1302MATWCLD



ONTEC S M2302MATWCLD



OPRAWA DWUSTRONNA OSO

ACCESSORIES ► ACCESSORI

OPRAWA DWUSTRONNA OSO	33829	5902052523870
UCHW PODT OS S2 S3 IT	33830	5902052594153
ZEST POD OR00 B	28985	5902052532032
ZEST MONT S20 FLAGA	33876	5902052531899
ZEST MONT OS05	33871	5902052523856
ZEST MONT OS205	33877	5902052552917
ZEST MON OS010 W	28974	5902052546534

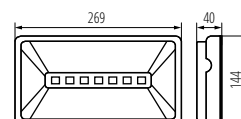

ONTEC S

Kanlux ITECH

BLOC DE SECOURS LED ▶ LAMPADA LED DI EMERGENZA



ITECH



UCHW PODT OS S2 S3 IT

L'éclairage de sécurité ou anti-panique est installé dans les espaces de type « open space » afin d'éviter des crises de panique. L'éclairage permet de rejoindre un endroit où le chemin d'évacuation est marqué, ainsi que de marquer le chemin d'évacuation, en fonction du prisme installé dans le luminaire.

Matériau du boîtier: matériau plastique

L'illuminazione d'emergenza o antipanico viene utilizzata negli spazi aperti per contrastare il panico. Permette di raggiungere un luogo dove è possibile vedere una via di fuga segnalata e la marcatura della stessa, a seconda del prisma utilizzato nell'apparecchio d'illuminazione.

Materiale del corpo: plastica



MODE

USE



h)

ST AT

ITECH M1 60 NM STW	27769	5902052537068	1,2	secours di emergenza	éclairage anti-panique illuminazione antipanico	1	✓		
ITECH M2 302MATW	33812	5902052530793	6,4	secours et veille interrupteur automatique	éclairage anti-panique illuminazione antipanico	3		✓	
ITECH M5 305MATW	33814	5902052531172	6	secours et veille interrupteur automatique	éclairage anti-panique illuminazione antipanico	3		✓	
ITECH C1 302MATW	33815	5902052530854	6,4	secours et veille interrupteur automatique	éclairage de balisage illuminazione della via di evacuazione	3		✓	
ITECH M2 302MSTW	33821	5902052530786	6,4	secours et veille interrupteur automatique	éclairage anti-panique illuminazione antipanico	3	✓		
ITECH M5 105MSTW	33822	5902052531141	6	secours et veille interrupteur automatique	éclairage anti-panique illuminazione antipanico	1	✓		
ITECH C1 302STW	33823	5902052530847	6,4	secours et veille interrupteur automatique	éclairage de balisage illuminazione della via di evacuazione	3	✓		
ITECH F2 105MSTW	33824	5902052531028	6	secours et veille interrupteur automatique	éclairage de balisage illuminazione della via di evacuazione	1	✓		
ITECH M5 105MATW	33832	5902052531165	6	secours et veille interrupteur automatique	éclairage anti-panique illuminazione antipanico	1		✓	
ITECH S1 302MATW	33833	5902052541010	6,4	secours et veille interrupteur automatique	éclairage anti-panique illuminazione antipanico	3		✓	
ITECH C2 105MATW	33834	5902052530922	6	secours et veille interrupteur automatique	éclairage de balisage illuminazione della via di evacuazione	1		✓	
ITECH F1 302MATW	33835	5902052540969	6,4	secours et veille interrupteur automatique	éclairage de balisage illuminazione della via di evacuazione	3		✓	
ITECH F2 105MATW	33836	5902052531042	6	secours et veille interrupteur automatique	éclairage de balisage illuminazione della via di evacuazione	1		✓	
ITECH W2 105MATW	33837	5902052531288	6	secours et veille interrupteur automatique	éclairage des issues de secours, des dispositifs de protection incendie illuminazione di uscite di emergenza, dispositivo antincendio	1		✓	
ITECH M1 60 NMATW	33872	5902052537051	1,2	secours di emergenza	éclairage anti-panique illuminazione antipanico	1		✓	

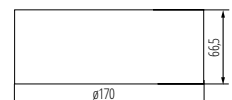

ACCESSORIES ▶ ACCESSORI

UCHW PODT OS S2 S3 IT | **33830** | 5902052594153

ONTEC R

BLOC DE SECOURS LED ▶ LAMPADA LED DI EMERGENZA



ONTEC R C



ONTEC R M



ZESTAW MONT. P/T ONTEC R

L'éclairage de secours ou d'antipanique est utilisé pour des pièces de type open space pour prévenir la panique. Il permet d'accéder à un endroit balisé par un chemin d'évacuation ainsi que l'évacuation elle-même, selon le pictogramme du luminaire.

Matériau du boîtier: matériau plastique
Matériau du diffuseur: matériau plastique

L'illuminazione di emergenza o di antipanico viene utilizzata in ambienti di tipo "open space" per prevenire il panico. Permette di raggiungere il luogo dove è possibile vedere la via di fuga segnalata e l'evacuazione stessa, a seconda del prisma utilizzato nell'apparecchio di illuminazione.

Materiale del corpo: plastica
Diffusore: plastica



MODE

USE



ST AT

ONTEC R M1 60N M STW	29098	5902052535736	1,2	secours di emergenza	éclairage anti-panique illuminazione antipanico	1	✓				
ONTEC R C1 60N M STW	33826	5902052535965	1,2	secours di emergenza	éclairage de balisage illuminazione della via di evacuazione	1	✓				
ONTEC R C1 302 M STW	33827	5902052529179	7,2	secours et veille interrupteur automatique	éclairage de balisage illuminazione della via di evacuazione	3	✓				
ONTEC R M1 60N M ATW	33850	5902052535781	1,2	secours di emergenza	éclairage anti-panique illuminazione antipanico	1		✓			
ONTEC R M2 302 M ATW	33851	5902052529124	7,2	secours et veille interrupteur automatique	éclairage anti-panique illuminazione antipanico	3		✓			
ONTEC R C1 60N M ATW	33852	5902052536023	1,2	secours di emergenza	éclairage de balisage illuminazione della via di evacuazione	1		✓			
ONTEC R M5 105 M STW	33860	5902052520732	6,7	secours et veille interrupteur automatique	éclairage anti-panique illuminazione antipanico	1	✓				
ONTEC R M5 105 M ATW	33870	5902052520787	6,7	secours et veille interrupteur automatique	éclairage anti-panique illuminazione antipanico	1		✓			

220-240 AC |
 50 |
 IP 20 |
 Tc (K) 5000 |
 SMD |
 |
 CE |
 EAC |
 CNBOP |
 UK CA

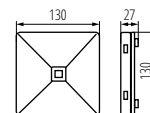

ACCESSORIES ▶ ACCESSORI

ZEST PODT OR00 W | **33831** | 5902052532025

ONTEC R



PICTO ONTEC G D5

PICTO ONTEC G D5	27482	5905339274823
PICTO ONTEC G D2	27483	5905339274830
PICTO ONTEC G D3	27484	5905339274847
PICTO ONTEC G D8	27485	5905339274854
PICTO ONTEC G D7	27488	5905339274885
PICTO ONTEC G W1	27490	5905339274908
PICTO ONTEC G F1	27497	5905339274977
PICTO ONTEC G F2	27498	5905339274984
PICTO ONTEC G DB	27499	5905339274991
PICTO ONTEC G DC	27500	5905339275004



PICTO ONTEC G D5



PICTO ONTEC G D2



PICTO ONTEC G D3



PICTO ONTEC G D8



PICTO ONTEC G D7



PICTO ONTEC G W1



PICTO ONTEC G F1



PICTO ONTEC G F2



PICTO ONTEC G DB



PICTO ONTEC G DC

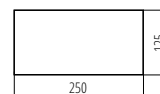



PICTO ONTEC S D5

PICTO ONTEC S D5	27505	5905339275059
PICTO ONTEC S D2	27506	5905339275066
PICTO ONTEC S D3	27507	5905339275073
PICTO ONTEC S D8	27508	5905339275080
PICTO ONTEC S D1	27509	5905339275097
PICTO ONTEC S D6	27510	5905339275103
PICTO ONTEC S D7	27511	5905339275110
PICTO ONTEC S D4	27512	5905339275127
PICTO ONTEC S W1	27513	5905339275134
PICTO ONTEC S W2	27514	5905339275141
PICTO ONTEC S F1	27520	5905339275202
PICTO ONTEC S DB	27522	5905339275226
PICTO ONTEC S DC	27523	5905339275233



PICTO ONTEC S D5



PICTO ONTEC S D6



PICTO ONTEC S F1



PICTO ONTEC S D2



PICTO ONTEC S D7



PICTO ONTEC S DB



PICTO ONTEC S D3



PICTO ONTEC S D4



PICTO ONTEC S DC



PICTO ONTEC S D8



PICTO ONTEC S W1



PICTO ONTEC S D1



PICTO ONTEC S W2

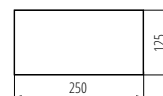

PICTO ONTEC S

Kanlux

IT

BANDE ADHÉSIVE ISOLANTE ► NASTRO ADESIVO ISOLANTE

IT-1/20- MIX : unité d'emballage contenant 10 pièces.
IT-1 : offert uniquement en emballages intermédiaires (10 pièces)
IT-1 / 20- MIX : confezione da 10 pezzi.
IT-1: offerto solo in confezione intermedia (10 pezzi)



IT-1/10-B

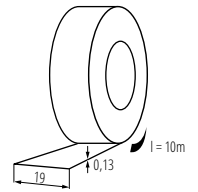

IT-1/10

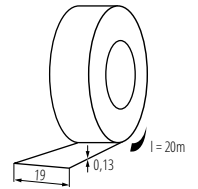

IT-1/20

IT-1/10-B	01257	5905339012579	noir nero
IT-1/20-B	01271	5905339012715	noir nero
IT-1/20-Y	01272	5905339012722	jaune giallo
IT-1/20-RE	01273	5905339012739	rouge rosso
IT-1/20-GN	01274	5905339012746	vert verde
IT-1/20-BL	01275	5905339012753	bleu azzurro
IT-1/20-W	01276	5905339012760	blanc bianco
IT-1/20-Y/GN	01277	5905339012777	jaune / vert giallo / verde
IT-1/20-MIX	01283	5905339012838	multicolore



SYMBOLES UTILISÉS LEGENDA



IP IP Indication du degré de résistance à la pénétration des solides, de la poussière et de l'humidité. IP Indicazione del grado di resistenza alla penetrazione di solidi, polvere e umidità

Degré de protection contre le contact involontaire avec des pièces sous tension
Grado di protezione contro il contatto involontario con parti in tensione

IP	Illustration / Disegno	Description / Descrizione	Explication / Spiegazione
0		Pas de protection Nessuna protezione	Aucune mesure de protection particulière Nessuna protezione
1		Protection contre les objets solides d'une taille supérieure à 50 mm Protezione contro corpi solidi superiori a 50 mm di diametro	Grande surface du corps humain, égale, par exemple, à la paume de la main (aucune protection contre le contact). Solides de plus de 50 mm de diamètre Nessuna protezione al tatto. Una vasta area del corpo umano, ad esempio simile alla superficie di una mano. Oggetti solidi di diametro superiore a 50 mm
2		Protection contre les objets solides de plus de 12 mm Protezione contro oggetti solidi superiori a 12 mm	Doigts ou objets similaires ne dépassant pas 80 mm de longueur. Objets solides d'un diamètre n'excédant pas 12 mm Dita o oggetti simili per dimensione, di lunghezza non superiore a 80 mm. Oggetti solidi con un diametro non superiore a 12 mm
3		Protection contre les objets solides dépassant 2,5 mm Protezione contro corpi solidi superiori a 2,5 mm di diametro	Outils, fils, etc. dont le diamètre ou l'épaisseur dépasse 2,5 mm. Solides d'un diamètre supérieur à 2,5 mm Strumenti, filo, ecc. con un diametro o uno spessore maggiore di 2,5 mm. Oggetti solidi con un diametro maggiore de 2,5 mm
4		Protection contre les particules solides de plus de 1 mm Protezione contro corpi solidi superiori a 1 mm di diametro	Fil ou ruban d'une épaisseur de 1 mm. Solides de plus de 1 mm de diamètre Filo o nastro di 1 mm di spessore. Oggetti solidi con un diametro superiore a 1 mm
5		Étanchéité à la poussière protezione contro le polveri (nessun deposito nocivo)	Une petite quantité de poussière pénètre dans l'enceinte, mais elle est si faible qu'elle n'a pas d'incidence sur le fonctionnement de l'appareil. Effet négatif sur le fonctionnement de l'équipement. Una piccola quantità di polvere entra all'interno dell'involucro ma è così piccola che non esercita alcun influsso negativo sul funzionamento dell'apparecchio
6		Étanchéité à la poussière totalmente protégé contre les polveri	La poussière ne pénètre pas dans le boîtier La polvere non entra all'interno dell'involucro

Degré de protection contre l'humidité
Il grado di protezione contro l'umidità

IP	Illustration / Picture	Description / Disegno	Explication / Spiegazione
0		Pas de protection Nessuna protezione	Aucune mesure de protection particulière Nessuna misura di protezione speciale
1		Protection contre les gouttes d'eau tombant verticalement Protezione contro le cadute verticali di gocce d'acqua	Les gouttes d'eau tombant verticalement ne doivent pas avoir d'effets nuisibles sur l'appareil. Le gocce d'acqua che cadono verticalmente non provocano effetti dannosi sull'apparecchio
2		Protection contre les gouttes d'eau jusqu'à une inclinaison de 15° Protezione contro le cadute di gocce d'acqua o pioggia fino a 15° dalla verticale	Les gouttes d'eau tombant verticalement ne doivent pas avoir d'effets nuisibles lorsque le couvercle de l'appareil est incliné jusqu'à 15° de sa position normale. Protezione contro le cadute di gocce d'acqua o pioggia fino a 15° dalla verticale
3		Protection contre les projections d'eau Protezione contro gli spruzzi d'acqua	L'eau pulvérisée tombant à un angle de 60° par rapport à la verticale n'a pas d'effet nocif. Protezione contro le cadute di gocce d'acqua o pioggia fino a 60° dalla verticale
4		Protection contre les éclaboussures Protezione contro gli spruzzi d'acqua	Les éclaboussures d'eau sur le couvercle, quelle que soit la direction, n'ont pas d'effets nocifs. Protezione contro gli spruzzi d'acqua da tutte le direzioni
5		Protection contre les jets d'eau Protezione contro i getti d'acqua	L'eau provenant d'une source dirigée vers le boîtier depuis n'importe quelle direction ne devrait pas causer de dommages. Protezione contro i getti d'acqua
6		Protection contre les vagues Protezione contro le onde	L'eau, après avoir été inondée par une vague ou par un jet puissant, ne peut pas entrer dans le boîtier en une quantité pouvant causer des effets néfastes. Protezione contro i getti d'acqua potenti
7		Protection contre l'immersion Protezione contro gli effetti delle immersioni temporanee	Lorsque l'équipement est immergé dans l'eau pendant une certaine période et à une certaine pression, l'eau ne doit pas entrer dans l'enceinte en quantité telle qu'elle puisse provoquer des effets néfastes. Quando il dispositivo è immerso in acqua temporaneamente e ad una certa pressione, l'acqua non può entrare nell'involucro in tale quantità da provocare effetti dannosi
8		Protection contre l'immersion profonde Protezione contro gli effetti delle immersioni continue	Appareil adapté à une immersion de longue durée dans l'eau dans les conditions spécifiées par le fabricant. Il dispositivo è progettato per l'immersione a lungo termine in acqua in condizioni specificate dal produttore

SYMBOLES UTILISÉS LEGENDA



Classe de protection Classe di sicurezza	Symbole Simbolo	Explication Spiegazione
0	Absent Assente	La protection contre les chocs électriques est assurée par l'isolation de base. En cas d'endommagement de l'isolation, la protection contre les chocs électriques doit être assurée par les éléments suivants conditions environnementales favorables et position de l'appareil qui ne permet pas un contact direct La protezione contro le scosse elettriche è fornita dall'isolamento di base. In caso di danneggiamento dell'isolamento, una protezione contro le scosse elettriche dovrebbe dalle condizioni ambientali favorevoli e posizione del dispositivo che non ne permette il contatto diretto
I		Dans les appareils de la classe de sécurité I, la sécurité est assurée par la connexion de toutes les parties conductrices sous tension au conducteur de protection, ou directement à la terre Gli apparecchi con classe di protezione I, sono provvisti di isolamento principale e gli involucri sono muniti di morsetto per la messa a terra.
II		Dans les équipements de classe II, la sécurité est assurée par une isolation double ou renforcée qui, dans des conditions environnementales données et à la tension nominale est considéré comme incassable Sono provvisti di isolamento supplementare. Dispongono di un isolamento doppio o rinforzato.
III		La protection contre les chocs électriques dans les équipements de classe III est assurée en abaissant la tension d'alimentation à une valeur sûre dans des conditions environnementales données In questi dispositivi la protezione contro i contatti indiretti è assicurata dal tipo di alimentazione a bassissima tensione di sicurezza.

La température de couleur Tc [K] est la température d'un corps noir à laquelle il émet un rayonnement lumineux de la même couleur que la source considérée. Il s'agit donc d'une mesure objective de l'impression de la couleur d'une source lumineuse donnée
La temperatura di colore, o temperatura colore, è una grandezza fisica associata alla tonalità della luce: a ogni temperatura corrisponde una sola tonalità. Si misura in kelvin.

<2700K	Couleur blanc-jaune	Colore giallo-bianco
2700-3300K	Couleur blanc chaud	Colore bianco caldo
3300-5300K	Couleur neutre (blanc)	Colore neutro (bianco)
>5300K	Couleur lumière du jour (blanc froid)	Colore del giorno (bianco freddo)

SYMBOLES UTILISÉS SIMBOLI UTILIZZATI



27395	code Kanlux / codice Kanlux	flux lumineux / flusso luminoso	réglage angulaire du luminaire [°] / regolazione angolare della lampada [°]
5902052559695	code EAN / EAN code	flux lumineux utile / flusso luminoso utile nominale	réglage angulaire du luminaire dans deux axes / regolazione angolare del corpo illuminante su due assi
	couleur / colore	indice de rendu des couleurs Ra / indice di resa cromatica Ra	réglage angulaire du luminaire dans un axe / regolazione angolare del corpo illuminante su un asse
	tension nominale / tensione nominale	la plage de température ambiante à laquelle le produit est adapté / intervallo di temperatura ambiente a cui il prodotto è adatto	orifice de montage / foro di montaggio
	alimentation unilatérale de lampes fluorescentes T8 LED / alimentazione unilaterale di lampade fluorescenti a LED T8	la plage d'humidité pour laquelle le produit est adapté / range di umidità dell'aria alla quale il prodotto è adatto	type de ballast: électronique / tipo reattore: elettronico
	puissance / potenza nominale	angle de distribution de la lumière / angolo di distribuzione della luce	type de ballast: inductif / tipo reattore: induttivo
		durée de vie / durata	alimentation - tension constante / tipo di alimentazione - tensione costante
	fréquence nominale / frequenza nominale	classe d'efficacité énergétique (Ei) / classe di efficienza energetica (Ei)	alimentation électrique - courant continu / tipo di alimentazione - corrente costante
	tension d'entrée / tensione di ingresso	ne pas l'utiliser dans des circuits avec des appareils électronique (par exemple, avec un gradateur) / non dimmerabile (ad es. con un dimmer)	Degré de résistance à la pénétration d'ob- jets solides et l'humidité (IP) / grado di resistenza all'ingresso di solidi e umidità (IP)
	tension de sortie / tensione di uscita	possibilité de faire travailler avec un grada- teur / dimmerabile	le degré de protection contre les chocs mécanique / il grado di protezione contro gli urti meccanico
	courant de sortie / corrente di uscita	possibilité de faire travailler avec un grada- teur 1-10V / dimmerabile 1-10V	pour usage à l'intérieur / per uso interno
	courant nominal / corrente nominale	possibilité de faire travailler avec un grada- teur DALI / compatible con protocollo DALI	pour usage extérieur / per uso esterno
		équipé d'un interrupteur marche/arrêt / dotato di interruttore	pour l'intérieur ou extérieur / per uso interno o esterno
	consommation annuelle d'énergie / consumo energetico	équipé d'un hygromètre / dotato di igrometro	conformité aux normes européennes (CE) / conformità alle norme europee (CE)
	nombre de cycles marche/arrêt / numero di cicli acceso/spento	équipé d'une minuterie / dotato di timer	certificat de conformité de qualité de production selon les normes approuvées sur le territoire de l'Union douanière / Certificato di Conformità che conferma la qualità produzione con standard approvati nel territorio dell'Unione doganale
	déclaration d'équivalence de puissance / dichiarazione di equivalenza riguardante la potenza	équipé d'un interrupteur à tirette / dotato di interruttore a strappo	le produit est conforme à la réglementation applicable au Royaume-Uni (UK) / Questo prodotto è conforme alle disposi- zioni legislative del Regno Unito
	source lumineuse non remplaçable / lampadina non sostituibile	sans mercure / privo di mercurio	le produit est conforme à la réglementation applicable en Ukraine i (UK) / questo prodotto è conforme alle disposizio- ni legislative Ukraine
	source lumineuse remplaçable / lampadina sostituibile	teneur en mercure / contiene mercurio	classe de protection contre les chocs électriques I / classe di protezione contro le scosse elettriche elettrico I
	température de couleur (Tc) / temperatura di colore (Tc)	distance minimale de l'objet éclairé / distanza minima dall'oggetto illuminato	classe de protection contre les chocs électriques II / classe di protezione contro le scosse elettriche elettrico II
	couleur de la lumière / colore della luce	facteur de puissance / fattore di potenza	classe de protection contre les chocs électriques III / classe di protezione contro le scosse elettriche elettrico III
	efficacité lumineuse / efficienza luminosa	longueur / lunghezza	la lampe n'est pas destinée à l'éclairage d'accentuation / la lampada non è destinata all'illuminazione d'accento
	cohérence des couleurs [SDCM] / efficienza luminosa [SDCM]	UGR / UGR	
		luminaire orientable horizontalement / orientabile orizzontalmente	
		luminaire orientable verticalement / orientabile verticalmente	
		luminaire fixe / non orientable/fisso	

SYMBOLS UTILISÉS SIMBOLI UTILIZZATI



	la lampe destinée à l'éclairage d'accentuation / la lampada è destinata all'illuminazione accentuata
	adapté à l'installation sur des surfaces normalement inflammables / possibilità di montaggio su superfici infiammabili
	source lumineuse incluse / lampadina inclusa
	piles de l'émetteur / batterie del telecomando
	contrôle : 2,4 GHz RF / controllo: RF 2,4 GHz
	câble avec fiche - DC / cavo dotato di una spina - DC

type de source lumineuse / tipo di sorgente luminosa

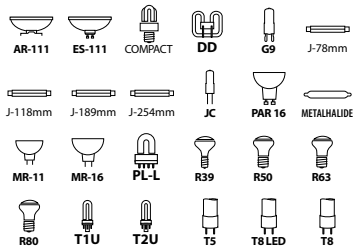

culot / attacco

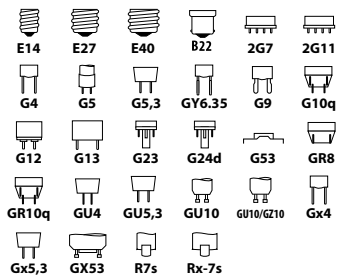

type de diode / LED type

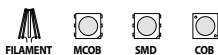

direction de l'éclairage / tipo di direzione



type de connexion / tipo di connessione



domino à vis / connettore



bloc de raccordement / cablaggio a vite

	bloc de raccordement / autobloccante
	câble avec fiche / cavo dotato di spina
	extrémités des câbles libres / estremità del cavo libere
	diamètre du câble / diametro del filo
	longueur du câble / lunghezza del cavo
	gamme de sections des conducteurs utilisés / gamma di sezioni dei cavi utilizzati
	la longueur du câble d'alimentation se terminant en fiche / lunghezza del cavo di alimentazione dotato di spina

montage / installazione

	à monter sur le mur / per montaggio a parete
	à encastrier dans le mur / da incasso a parete
	à monter au plafond / da montare a soffitto
	à encastrier dans le plafond / da incassare nel soffitto
	à encastrier dans le plafond ou le mur / da incassare a soffitto o a parete
	à installer au sol / per montaggio a terra
	à encastrier dans le sol / per montaggio a terra
	à monter au plafond, au mur ou sur au sol / da montare a soffitto, parete
	sur rail TH35 / sul binario TH35
	sur rail TEAR / sul binario TEAR
	à suspendre au plafond / da appendere al soffitto

type de détecteur / tipo di sensore

	PIR
	micro wave
	2 x PIR
	3 x PIR
	caractéristiques de déclenchement / caratteristica di innesco
	durée de fonctionnement du capteur / tempo di funzionamento del sensore
	angle de fonctionnement du capteur / angolo di lavoro del sensore
	champ du capteur / cavo dotato di spina

	réglage du niveau d'intensité lumineuse, à laquelle le capteur détecte un mouvement / impostazione del livello di intensità luminosa, dove il sensore rileva il movimento
	volume / rumorosità
	débit volumétrique [m ³ /h] / portata d'aria [m ³ / h]
	tours de moteur / velocità del motore
	nombre de pôles / numero di poli
	1P 2P 3P 4P
	nombre de modules / numero di moduli
	application / applicazione
	mode de fonctionnement / modalità operativa
	test standard / test standard
	test automatique / test automatico
	temps de travail / tempo di emergenza

INDEX ALPHABÉTIQUE
INDICE ALFABETICO

ABETE LED 60 GR	36570	285	ALIN LED LINE	xxx	18
ABETE LED 80 GR	36571	285	ALOR DSL-B	26727	169
ABETE LED EL 20 GR	36572	285	ALOR DSL-W	26726	169
ABETE LED EL 20 SE-GR	36573	285	ALOR DSO-B	26791	169
ADI 350 1x3W	1440	335	ALOR DSO-W	26790	169
ADTR	xxx	30	ALOR DTL-B	26732	169
ADTR 12030 B	27614	213	ALOR DTL-W	26731	169
ADTR 12030 B	27614	209	ALOR DTO-B	26796	169
ADTR 12030 SR	27612	213	ALOR DTO-W	26795	169
ADTR 12030 SR	27612	209	ALREN DTL-B	26754	176
ADTR 12030 W	27611	213	ALREN DTL-C/M	26756	176
ADTR 12030 W	27611	209	ALREN DTL-W	26753	176
ADTR 3060 B	29842	213	ALREN R DTL-B	26757	176
ADTR 3060 SR	29841	213	ALREN R DTL-W	26758	176
ADTR 3060 W	29840	213	AMAZI LED 17,5W NW B	37325	116
ADTR 6060 B	27615	213	ANTEM LED 100W-NW B	33204	266
ADTR 6060 B	27615	209	ANTEM LED 10W-NW B	33200	266
ADTR 6060 SR	27610	213	ANTEM LED 10W-NW-SE B	33205	266
ADTR 6060 SR	27610	209	ANTEM LED 20W-NW B	33201	266
ADTR 6060 W	27613	213	ANTEM LED 20W-NW-SE B	33206	266
ADTR 6060 W	27613	209	ANTEM LED 30W-NW B	33202	266
ADTR-H 12030 B	33391	209	ANTEM LED 30W-NW-SE B	33207	266
ADTR-H 12030 SR	33392	209	ANTEM LED 50W-NW B	33203	266
ADTR-H 12030 W	33390	209	ANTEM LED 50W-NW-SE B	33208	266
ADTR-H 12030 W	33390	211	APO TM -3	7980	340
ADTR-H 3060 W	33393	211	APRILA DTO-W	26738	165
ADTR-H 6060 B	29845	209	APUS LED AC B-NW	26536	196
ADTR-H 6060 SR	29844	209	APUS LED AC B-WW	26537	196
ADTR-H 6060 W	29843	209	APUS LED AC-CW	23801	196
ADTR-H 6060 W	29843	211	APUS LED AC-WW	23800	196
ADTR-H 6262 W	33435	209	APUS LED B-NW	26538	196
ADTR-H 76MM 6060 W	33398	209	APUS LED B-WW	26539	196
ADTR-S 6060 W	27616	209	APUS LED CW	23107	196
ADTR-S-H 6060 W	27617	209	APUS LED NW	32488	196
AGEO DSO-B	33165	165	APUS LED PIR B-NW	29856	196
AGEO DSO-W	33166	165	APUS LED PIR B-WW	29857	196
AGZAR C 3xE14 B	36252	104	APUS LED PIR NW	27379	196
AGZAR C 3xE14 W	36253	104	APUS LED PIR WW	27370	196
AGZAR E14 B	36250	144	APUS LED W-CW	26841	196
AGZAR E14 W	36251	144	APUS LED W-NW	27378	196
AGZAR EL-10 B	36254	144	APUS LED W-W	23106	196
AGZAR EL-10 W	36255	144	APUS LED W-WW	26840	196
AKVEN LED	25720	300	AQILO E14 IP65 DSO-B	36642	108
AKVO IP44 15W-NW-B	36660	193	AQILO E14 IP65 DSO-GR	36640	108
AKVO IP44 15W-NW-B S	36651	192	AQILO E14 IP65 DSO-W	36641	108
AKVO IP44 15W-NW-C	36661	193	AQILO E27 IP65 DSO-B	36645	108
AKVO IP44 15W-NW-C S	36652	192	AQILO E27 IP65 DSO-GR	36643	108
AKVO IP44 15W-NW-W	36659	193	AQILO E27 IP65 DSO-W	36644	108
AKVO IP44 15W-NW-W S	36650	192	AQILO IP65 DSO-B	33361	108
AKVO IP44 20W-NW-B	36663	193	AQILO IP65 DSO-GR	33362	108
AKVO IP44 20W-NW-B S	36654	192	AQILO IP65 DSO-W	33360	108
AKVO IP44 20W-NW-C	36664	193	AREL FRAME DO 14W W	33651	252
AKVO IP44 20W-NW-C S	36655	192	AREL LED DL 10W-NW	29586	252
AKVO IP44 20W-NW-W	36662	193	AREL LED DL 14W-NW	29590	252
AKVO IP44 20W-NW-W S	36653	192	AREL LED DL 6W-NW	29582	252
AKVO IP44 23W-NW-B	36666	193	AREL LED DO 10W-NW	29584	252
AKVO IP44 23W-NW-B S	36657	192	AREL LED DO 10W-WW	29585	252
AKVO IP44 23W-NW-C	36667	193	AREL LED DO 14W-NW	29588	252
AKVO IP44 23W-NW-C S	36658	192	AREL LED DO 14W-WW	29589	252
AKVO IP44 23W-NW-W	36665	193	AREL LED DO 6W-NW	29580	252
AKVO IP44 23W-NW-W S	36656	192	AREL LED DO 6W-WW	29581	252
ALDO 4LED 1X120	26361	228	ARET 1XMR16-W	26720	175
ALDO 4LED 1X150	26362	228	ARET 2XMR16-W	26723	175
ALDO 4LED 1X60	26360	228	ARGUS II CT-2114-AN	37150	182
ALDO 4LED 2X120	26364	228	ARGUS II CT-2114-BR/M	37151	182
ALDO 4LED 2X150	26365	228	ARGUS II CT-2114-C	37152	182
ALER JQ-30-B	461	326	ARGUS II CT-2114-C/M	37153	182
ALER JQ-30-W	460	326	ARGUS II CT-2114-G	37154	182
ALER MINI-W	23450	326	ARGUS II CT-2114-GM	37155	182
ALER N-B	37363	322	ARGUS II CT-2114-W	37156	182
ALER N-W	37362	322	ARGUS II CT-2115-AN	37157	182
ALIN 4LED	xxx	20	ARGUS II CT-2115-BR/M	37158	182
ALIN 4LED LINE	xxx	22	ARGUS II CT-2115-C	37159	182
ALIN LED	xxx	16	ARGUS II CT-2115-C/M	37160	182

ARGUS II CT-2115-G	37161	182	BLINGO 34W 4080 60CW	37172	208
ARGUS II CT-2115-GM	37162	182	BLINGO 34W 4080 60NW	37171	208
ARGUS II CT-2115-W	37163	182	BLINGO 38W 4560 120NW	37177	208
ARVOS LED 37W CCT B	37330	120	BLINGO 38W 4560 60NW	37176	208
ARVOS LED 37W CCT W	37331	120	BLINGO DALI SET 38W	28515	211
ASTEN IP44 12W-NW-B	26684	190	BLINGO DALI SET 38W	28515	211
ASTEN IP44 12W-NW-W	26687	190	BLINGO DRV 24W ON-OFF	37272	211
ASTEN IP44 15W-NW-B	26685	190	BLINGO DRV 24W ON-OFF	37272	211
ASTEN IP44 15W-NW-W	26688	190	BLINGO DRV 32W ON-OFF	37269	211
ASTEN IP44 8W-NW-B	26683	190	BLINGO DRV 32W ON-OFF	37269	211
ASTEN IP44 8W-NW-W	26686	190	BLINGO DRV 40W ON-OFF	37270	211
ASTEN LED IP44 12W-NW	26681	190	BLINGO DRV 40W ON-OFF	37270	211
ASTEN LED IP44 15W-NW	26682	190	BLINGO DRV40W1-10V BK	37268	211
ASTEN LED IP44 8W-NW	26680	190	BLINGO DRV40W1-10V BK	37268	211
ASTIM IP44 12W-NW-B	34933	189	BLINGO DRV42W DALI BK	37267	211
ASTIM IP44 12W-NW-C	34935	189	BLINGO DRV42W DALI BK	37267	211
ASTIM IP44 12W-NW-W	34934	189	BLINGO PU 36W 6262 NW	33188	208
ASTIM IP44 8W-NW-B	34930	189	BLINGO TN24-28W6060NW	33178	208
ASTIM IP44 8W-NW-C	34932	189	BLINGO TN38W 6060 NW	33177	208
ASTIM IP44 8W-NW-W	34931	189	BLINGO TUN48W 6060 NW	33179	208
ATL1 18W-930-S6-B	33131	304	BLINGO U EI25LM 120NW	37266	210
ATL1 18W-930-S6-W	33130	304	BLINGO U EI25LM 30NW	37271	210
ATL1 18W-940-S6-B	33133	304	BLINGO U EI25LM 60NW	37265	210
ATL1 18W-940-S6-W	33132	304	BLINGO U24W 4000 60NW	37179	208
ATL1 30W-930-S6-B	33135	304	BLINGO U34W 4080 120N	37175	208
ATL1 30W-930-S6-W	33134	304	BLINGO U34W 4080 60NW	37173	208
ATL1 30W-940-S6-B	33137	304	BLURRO 2xGU10 CO-B	32952	113
ATL1 30W-940-S6-W	33136	304	BLURRO 2xGU10 CO-W	32953	113
ATL2 GU10-B	33139	306	BOLA LED 2xUSB WW W	37397	140
ATL2 GU10-W	33138	306	BONSA LED 17,5W NW	37322	115
ATL3 GU10-B	33144	306	BORD DLP-50-B	22552	111
ATL3 GU10-W	33145	306	BORD DLP-50-W	22551	111
ATL4 GU10-B	33146	307	BORD XS DLP-50-B	25478	112
ATL4 GU10-W	33147	307	BORD XS DLP-50-W	25479	112
ATL5 GU10-B	33148	307	BRAVO DALI SET 36W	28508	212
ATL5 GU10-W	33149	307	BRAVO DRIVER 28W	28029	212
AVAR 6060 40W-CW	26771	214	BRAVO DRIVER 36W	28025	212
AVAR 6060 40W-NW	26770	214	BRAVO DRIVER 40W	28026	212
AVAR 6262 40W-NW	26773	214	BRAVO PU28W3060NW W	28551	212
AVAR 6262 40W-WW	26774	214	BRAVO PU36W6060NW W	28002	212
AVAR DALI SET 40W	28512	214	BRAVO S 40W12030NW W	28022	212
AZ-10A	22371	333	BRAVO S 40W6060NW W	28010	212
BART EL-235	7080	277	BRAVO S/P GRIP 12030	28501	213
BENO 18W NW-L-SE W	32946	233	BRAVO S/P GRIP 60-62	28500	213
BENO 18W NW-L-W	32942	233	BR-GZ10	72369	340
BENO 18W NW-O-SE W	32944	233	BTL 18W-930-B	35651	308
BENO 18W NW-O-W	32940	233	BTL 18W-930-W	35650	308
BENO 24W NW-L-GR	33343	233	BTL 18W-940-B	35653	308
BENO 24W NW-L-SE GR	33347	233	BTL 18W-940-W	35652	308
BENO 24W NW-L-SE W	33346	233	BTL 28W-930-B	35655	308
BENO 24W NW-L-W	33342	233	BTL 28W-930-W	35654	308
BENO 24W NW-O-GR	33341	233	BTL 28W-940-B	35657	308
BENO 24W NW-O-SE GR	33345	233	BTL 28W-940-W	35656	308
BENO 24W NW-O-SE W	33344	233	BTL 38W-930-B	35659	308
BENO 24W NW-O-W	33340	233	BTL 38W-930-W	35658	308
BENO N 18W NW-L-SE GR	32949	233	BTL 38W-940-B	35661	308
BENO N 18W NW-O-SE GR	32948	233	BTL 38W-940-W	35660	308
BERG AD-7L	276	282	BTLW 18W-930-B	35663	309
BERG AD-7O	36430	282	BTLW 18W-930-W	35662	309
BERG DL-10L	7173	282	BTLW 18W-940-B	35665	309
BERG DL-10O	7172	282	BTLW 18W-940-W	35664	309
BILO 4,9W E14-NW	23428	64	CALIZA LED CCT W	37390	142
BILO 4,9W E14-WW	23429	64	CARSA V2LED 12W-NW-W	28948	260
BILO 4,9W E27-NW	23418	64	CARSA V2LED 18W-NW-W	28949	260
BILO 4,9W E27-WW	23419	64	CARSA V2LED 24W-NW-W	33541	260
BILO 6,5W E14-NW	26766	64	CARVO LED 17,5W NW	37321	114
BILO 6,5W E14-WW	26767	64	CHIRO GU10 DTL-B	29313	162
BILO 6,5W E27-NW	26768	64	CHIRO GU10 DTO-B	29311	162
BILO 6,5W E27-WW	26769	64	CHIRO GU10 DTO-W	29310	162
BISO LED EL 8W-GR	29260	275	CIRCO LED 12VDC 0-10W	24240	336
BISO LED EL 8W-W	29261	275	CIRCO LED 12VDC 0-15W	24241	336
BLINGO 24W 4320 60NW	37178	208	CLIPS BRAVO S/P 12030	28503	213
BLINGO 34W 3740 60WW	37170	208	CLIPS BRAVO S/P 60-62	28502	213
BLINGO 34W 4080 120NW	37174	208	CLIPS PANEL 120	37338	209

INDEX ALPHABÉTIQUE
INDICE ALFABETICO

CLIPS PANEL 120	37338	211	ELICEO DSO W	35288	172
CLIPS PANEL 60-62	37337	209	ELICEO DSO W/G	35283	172
CLIPS PANEL 60-62	37337	211	ELICEO DSO W/W	35281	172
CL-MAH PLUS	18593	225	ELICEO DSO YG	35295	172
CL-MAH PLUS-INOX	18594	225	ELICEO-ST DSO B/B	35284	172
CLP-REGIS/PT	72333	216	ELICEO-ST DSO W/G	35287	172
CLP-REGIS/PT	72333	217	ELICEO-ST DSO W/W	35285	172
COB SET 3m DIM-NW	26327	86	ELNIS L A	27809	170
COB SET 3m DIM-WW	26326	86	ELNIS L A/C	27808	170
COLIE DTO-B	26743	177	ELNIS L B/G	27810	170
COLIE DTO-G	26741	177	ELNIS L W	27804	170
COLIE DTO-GR	26744	177	ELNIS L W/A	27805	170
COLIE DTO-W	26740	177	ELNIS L W/C	27806	170
CONNECT C/D/E/I	26563	89	ELNIS S W	27800	170
CONNECT C/D/E/I	26563	90	ENALI EL-10 B	28761	136
CONNECT-L B	26604	88	ENALI EL-10 W	28760	136
CONNECT-L C	26562	89	ENALI EL-2I B	28763	136
CONNECTOR 8	19030	79	ENALI EL-2I W	28762	136
CONNECTOR 8-CP	19032	79	ENALI EL-3I B	28767	136
CONNECTOR 8-CPC	19033	79	ENALI EL-3I W	28766	136
CONNECTOR RGB 10	19038	85	ENALI EL-3O B	28765	136
CONNECTOR RGB 10-CP	19036	85	ENALI EL-3O W	28764	136
CONNECTOR RGB 10-CPC	19037	85	ENALI EL-4I B	28769	136
CONTROLLER LED RGB-RF	22140	85	ENALI EL-4I W	28768	136
CTR L 12/24V MONO/CTT	22147	87	ERINUS LED L B-NW	33333	194
CTR L 12/24V RG BW CTT	22148	87	ERINUS LED L B-WW	33332	194
CYBER TM -6	1016	334	ERINUS LED L GR-NW	33327	194
CYKLON EOL 100	70910	338	ERINUS LED L W-NW	33321	194
CYKLON EOL 100B	70911	338	ERINUS LED L W-WW	33320	194
CYKLON EOL 100HT	70936	338	ERINUS LED LL B-NW	33337	194
CYKLON EOL 100P	70937	338	ERINUS LED LL B-WW	33336	194
CYKLON EOL 100T	70938	338	ERINUS LED LL GR-NW	33331	194
CYKLON EOL 120	70915	338	ERINUS LED LL GR-WW	33330	194
CYKLON EOL 120B	70916	338	ERINUS LED LL W-NW	33325	194
CYKLON EOL 120HT	70941	338	ERINUS LED LL W-WW	33324	194
CYKLON EOL 120P	70942	338	ERINUS LED O B-NW	33335	194
CYKLON EOL 120T	70943	338	ERINUS LED O B-WW	33334	194
CYKLON EOL 150	70920	338	ERINUS LED O GR-NW	33329	194
CYKLON EOL 150B	70921	338	ERINUS LED O W-NW	33323	194
CYKLON EOL 150P	70947	338	ERINUS LED O W-WW	33322	194
CYKLON EOL 150T	70948	338	ERTON 140 OP-W	35770	244
DABA N LED SMD DL-16W	19062	238	ERTON 240 OP-W	35771	244
DABA PRO 25W NW-B	19065	238	ESG LED 9W GX53-CW	22424	77
DABA PRO 26W NW-SE-W	19066	238	ESG LED 9W GX53-NW	22423	77
DALLA CT-DTL50-B	22433	171	ESG LED 9W GX53-WW	22422	77
DALLA CT-DTL50-W	22431	171	ETISSA D20 GR	27000	106
DALLA CT-DTO50-B	22432	171	EVALO EL-1I B-SR	35691	126
DALLA CT-DTO50-W	22430	171	EVALO EL-1I W-SR	35690	126
DASTO 2SOC FR B	36585	302	EVALO EL-2I B-SR	35693	126
DERATO EL-10 B-SR	35640	124	EVALO EL-2I W-SR	35692	126
DERATO EL-10 W-SR	35641	124	EVALO EL-3I B-SR	35695	126
DERATO EL-2I B-SR	35642	124	EVALO EL-3I W-SR	35694	126
DERATO EL-2I W-SR	35643	124	EVALO EL-4I B-SR	35699	126
DERATO EL-3O B-SR	35644	124	EVALO EL-4I W-SR	35698	126
DERATO EL-3O W-SR	35645	124	EVALO EL-4O B-SR	35697	126
DERATO EL-4I B-SR	35646	124	EVALO EL-4O W-SR	35696	126
DERATO EL-4I W-SR	35647	124	EVALO EL-5I B-SR	35689	126
DRIVE LED 0-15W 12VDC	23860	336	EVALO EL-5I W-SR	35688	126
DROXY IP65 DSO-B	33126	186	EVALO FL 3xGU10 B-SR	35788	149
DROXY IP65 DSO-W	33125	186	EVALO FL 3xGU10 W-SR	35787	149
DULI LED 4W-NW-L-GR	33750	278	EVALO TL GU10 B-SR	35786	148
DULI LED 4W-NW-O-GR	33751	278	EVALO TL GU10 W-SR	35785	148
DULI LED 6,5W-NW-L-GR	33752	278	EVIT CT-DTL50-AL	18560	178
DULI LED 6,5W-NW-O-GR	33753	278	EVIT CT-DTO50-AL	18561	178
DUN 4,9W E14-NW	23435	59	EXATE LED 17,5W NW	37323	115
DUN 4,9W E14-WW	23434	59	FELINE DSL B/B	37256	159
DUN 6,5W E14-NW	23436	59	FELINE DSL B/W	37260	159
DUN 6,5W E14-WW	23437	59	FELINE DSL G/B	37257	159
ELICEO DSO B	35289	172	FELINE DSL G/W	37261	159
ELICEO DSO B/B	35280	172	FELINE DSL W/B	37258	159
ELICEO DSO BL	35298	172	FELINE DSL W/W	37259	159
ELICEO DSO GR	35296	172	FELINE DSO B/B	37250	158
ELICEO DSO PK	35297	172	FELINE DSO B/W	37255	158

FELINE DSO G/B	37251	158	GLOZO DSO SR/B	36225	156
FELINE DSO G/W	37254	158	GLOZO DSO SR/W	36221	156
FELINE DSO W/B	37252	158	GLOZO DSO W/B	36222	156
FELINE DSO W/W	37253	158	GLOZO DSO W/W	36218	156
FL AGOR HI 240W NW	33476	263	GORD XS DLP 50-B	25476	112
FL AGOR HI 300W NW	33478	263	GORD XS DLP 50-W	25477	112
FL AGOR HI GRID 240W	33482	263	GORDO N 1W CW-L-SR	18192	281
FL AGOR HI GRID 300W	33483	263	GORDO N 1W CW-O-SR	18193	281
FL AGOR LED 100W NW	33470	262	GORI 50	29002	292
FL AGOR LED 150W NW	33471	262	GORI 80	29003	292
FL AGOR LED 200W NW	33472	262	GORI EL 135 D	29000	292
FL AGOR/A HI 240W NW	33477	263	GORI EL 235 D	29001	292
FL AGOR/A HI 300W NW	33479	263	GOVIK DSO-B A	29236	160
FL AGOR/A LED 100W	33473	262	GOVIK DSO-B/G	29232	160
FL AGOR/A LED 150W	33474	262	GOVIK DSO-W A	29235	160
FL AGOR/A LED 200W	33475	262	GOVIK DSO-W/G	29231	160
FL SOLNAR SLR 8W NW-B	36605	269	GOVIK-ST DSO-B	29237	160
FL SONE SLR L NW-GR	36607	268	GOVIK-ST DSO-B/G	29234	160
FL SONE SLR M NW-GR	36606	268	GOVIK-ST DSO-W	29238	160
FLINI IP44 DSL-B	33120	186	GOVIK-ST DSO-W/G	29233	160
FLINI IP44 DSL-W	33121	186	GRIBLO 7 GR	36432	300
FLINI IP44 DSO-B	33122	186	GRIP GP\S	4862	339
FLINI IP44 DSO-W	33123	186	GRIP W\US	4863	339
FLUXY LED IP44 B	37311	146	GRL 11M10E27-B	35754	301
FLUXY LED IP44 BL	37312	146	GRL 15M15E27-B	35758	301
FLUXY LED IP44 GN	37313	146	GRL 6M5E27-B	35750	301
FLUXY LED IP44 W	37310	146	GWEN CT-DTL50-B	18530	178
FLUXY LED IP44 Y	37314	146	GWEN CT-DTO50-B	18531	178
FOGLER DL-2400	18120	242	HANDLE B/F	26596	88
FOGLER LED 14W-NW	18121	242	HANDLE B/F	26596	91
FRANCO 15LED SMD KT-B	22341	155	HANDLE C/D/E/I	26597	89
FRANCO 15LED SMD KT-W	22340	155	HANDLE C/D/E/I	26597	90
FUTURIO LED	xxx	28	HANDLE G	26598	92
G9-20W STAR	18420	99	HANDLE H	26599	93
G9-33W STAR	18421	99	HANDLE J/K	26595	94
G9-48W STAR	18422	99	HANDLE J/K	26595	95
G9-60W STAR	18423	99	HANDLE SIDE H	26600	93
GALOBA EL-10 B	33671	130	HAXA-DSO POWER LED-B	8103	204
GALOBA EL-10 W	33670	130	HB PRO LED HI 100W-NW	27155	272
GALOBA EL-21 B	33675	130	HB PRO LED HI 150W-NW	27156	272
GALOBA EL-21 W	33674	130	HB PRO LED HI 200W-NW	27157	272
GALOBA EL-31 B	33677	130	HBPH GRID 100W	33196	273
GALOBA EL-31 W	33676	130	HBPH GRID 150W	33197	273
GALOBA EL-41 B	33681	130	HBPH GRID 200W	33198	273
GALOBA EL-41 W	33680	130	HBPH LENS 120D 100W	33193	273
GALOBA EL-40 B	33679	130	HBPH LENS 120D 150W	33194	273
GALOBA EL-40 W	33678	130	HBPH LENS 120D 200W	33195	273
GALOBA W 1xGU10 B	33673	143	HBPH LENS 50D 100W	33190	273
GALOBA W 1xGU10 W	33672	143	HBPH LENS 50D 150W	33191	273
GARTO LED EL 8W-GR	29270	275	HBPH LENS 50D 200W	33192	273
GARTO LED EL 8W-W	29271	275	HERMI 7063NB	70524	245
GAVI CT-2116B-C	811	205	HERON II LED B	27602	152
GAVI CT-2116B-C/M	815	205	HERON II LED W	27603	152
GAVI CT-2116B-W	810	205	HIERRO LED	xxx	26
GAVI LED18 SMD-WW-C/M	19761	205	HIMA LED 23W-NW-B	22842	248
GLASI LED 3W P NW-B	33694	279	HIMA LED 23W-NW-W	22841	248
GLASI LED 3W P NW-GR	33695	279	HIMA LED 33W-NW-B	22844	248
GLASI LED 3W P NW-W	33693	279	HIMA LED 33W-NW-W	22843	248
GLASI LED 3W P WW-B	33691	279	HLDR-E14	2170	341
GLASI LED 3W P WW-GR	33692	279	HLDR-E14-F	2173	341
GLASI LED 3W P WW-W	33690	279	HLDR-E27	2160	341
GLOZO DSL B/B	36215	157	HLDR-E27-D	2162	342
GLOZO DSL B/W	36211	157	HLDR-E27-F	2161	342
GLOZO DSL G/B	36216	157	HLDR-G9	8220	342
GLOZO DSL G/W	36212	157	HLDR-GX5,3	72109	343
GLOZO DSL SR/B	36217	157	HLDR-GZ10	402	343
GLOZO DSL SR/W	36213	157	HLDR-R7S	405	343
GLOZO DSL W/B	36214	157	HOFI LED WW W	37393	141
GLOZO DSL W/W	36210	157	HORN CTC-3114-GM/N	2824	181
GLOZO DSO B/B	36223	156	IDO 6,5W E14-NW	23438	59
GLOZO DSO B/W	36219	156	IDO 6,5W E14-WW	23439	59
GLOZO DSO G/B	36224	156	IMBER LED CW	23521	188
GLOZO DSO G/W	36220	156	IMBER LED NW	23520	188
			IMBER LED WW	23522	188

INDEX ALPHABÉTIQUE
INDICE ALFABETICO

IMINES DSO-W	29031	165	IQ-LED G45E27 3,4W-CW	36693	60
INES 7061N	70525	246	IQ-LED G45E27 3,4W-NW	36692	60
INITA LED IP54 B	36321	147	IQ-LED G45E27 3,4W-WW	36691	60
INITA LED IP54 GN	36320	147	IQ-LED G45E27 5,9W-CW	36699	60
INITA LED IP54 R	36322	147	IQ-LED G45E27 5,9W-NW	36698	60
INITA LED IP54 W	36324	147	IQ-LED G45E27 5,9W-WW	36697	60
INITA LED IP54 Y	36323	147	IQ-LED GU 10 4,9W-CW	35258	65
INVO OP 107-L-GR	29173	294	IQ-LED GU 10 4,9W-NW	35257	65
INVO OP 47-L-GR	29171	294	IQ-LED GU 10 4,9W-WW	35256	65
INVO OP 77-L-GR	29172	294	IQ-LED GU10 6,5W-CW	35242	66
INVO OP EL-53-L-GR	29170	294	IQ-LED GU10 6,5W-NW	35241	66
INVO TR 107-O-GR	29177	295	IQ-LED GU10 6,5WS3-CW	35245	66
INVO TR 47-O-GR	29175	295	IQ-LED GU10 6,5WS3-NW	35244	66
INVO TR 77-O-GR	29176	295	IQ-LED GU10 6,5WS3-WW	35243	66
INVO TR EL-53-O-GR	29174	295	IQ-LED GU10 6,5W-WW	35240	66
IPER LED 10W-NW-L	37294	230	IQ-LED Life A60 7,2W-NW	33763	38
IPER LED 10W-NW-L-SE	37302	230	IQ-LED Life A60 7,2W-WW	33762	38
IPER LED 10W-NW-O	37290	230	IQ-LED Life G45 4,2W-NW	33761	38
IPER LED 10W-NW-O-SE	37298	230	IQ-LED Life G45 4,2W-WW	33760	38
IPER LED 19W-NW-L	37295	230	IQ-LED Life GU10 4,8W-NW	33765	38
IPER LED 19W-NW-L-SE	37303	230	IQ-LED Life GU10 4,8W-WW	33764	38
IPER LED 19W-NW-O	37291	230	IQ-LEDDIM A60 7,3W-NW	33723	42
IPER LED 19W-NW-O-SE	37299	230	IQ-LEDDIM A60 7,3W-WW	33722	42
IPER LED 26W-NW-L	37296	230	IQ-LEDDIM A6010,5W-NW	33725	42
IPER LED 26W-NW-L-SE	37304	230	IQ-LEDDIM A6010,5W-WW	33724	42
IPER LED 26W-NW-O	37292	230	IQ-LEDDIM A6013,6W-NW	33727	42
IPER LED 26W-NW-O-SE	37300	230	IQ-LEDDIM A6013,6W-WW	33726	42
IPER LED 35W-NW-L	37297	230	IQ-LEDDIM GU10 7W-CW	35248	67
IPER LED 35W-NW-L-SE	37305	230	IQ-LEDDIM GU10 7W-NW	35247	67
IPER LED 35W-NW-O	37293	230	IQ-LEDDIM GU10 7W-WW	35246	67
IPER LED 35W-NW-O-SE	37301	230	IQ-LEDEX GU 10 2,5W-NW	33769	65
IQ-LED A60 11W-CW	36681	40	IRS3xAAA LED PIR W-NW	37392	200
IQ-LED A60 11W-NW	36680	40	IT-1\20-RE	1273	351
IQ-LED A60 11W-WW	36679	40	IT-1\20-Y	1272	351
IQ-LED A60 3,4W-CW	36672	40	IT-1\20-Y\GN	1277	351
IQ-LED A60 3,4W-NW	36671	40	ITECH C1 302 STW	33823	346
IQ-LED A60 3,4W-WW	36670	40	ITECH C1 302MATW	33815	346
IQ-LED A60 5,9W-CW	36675	40	ITECH C2 105MATW	33834	346
IQ-LED A60 5,9W-NW	36674	40	ITECH F1 302MATW	33835	346
IQ-LED A60 5,9W-WW	36673	40	ITECH F2 105MATW	33836	346
IQ-LED A60 7,8W-CW	36678	40	ITECH F2 105MSTW	33824	346
IQ-LED A60 7,8W-NW	36677	40	ITECH M1 60 NM ST W	27769	346
IQ-LED A60 7,8W-WW	36676	40	ITECH M2 302MATW	33812	346
IQ-LED A67 N 19W-CW	33748	41	ITECH M2 302MSTW	33821	346
IQ-LED A67 N 19W-NW	33747	41	ITECH M5 105MATW	33832	346
IQ-LED A67 N 19W-WW	33746	41	ITECH M5 105MSTW	33822	346
IQ-LED AR-111 13W-NW	35253	72	ITECH M5 305MATW	33814	346
IQ-LED AR-111 13W-WW	35252	72	ITECH S1 302MATW	33833	346
IQ-LED C35E14 3,4W-NW	36683	56	ITECH W2 105MATW	33837	346
IQ-LED C35E14 3,4W-VW	36684	56	IVIAN LED 4,5W SN-NW	25783	253
IQ-LED C35E14 3,4W-WW	36682	56	IVIAN LED 4,5W SN-WW	25781	253
IQ-LED C35E14 5,9W-CW	36687	56	IVIAN LED 4,5W W-NW	25782	253
IQ-LED C35E14 5,9W-NW	36686	56	IVIAN LED 4,5W W-WW	25780	253
IQ-LED C35E14 5,9W-WW	36685	56	IVRI DTO-W	26736	175
IQ-LED ES-111 12W-NW	27319	72	J-1000W 189MM	10418	99
IQ-LED ES-111 12W-WW	27318	72	J-120W 118MM STAR	8500	100
IQ-LED EX T8 12W-CW	35255	73	J-120W 78MM STAR	8491	100
IQ-LED EX T8 12W-NW	35254	73	J-80W 78MM STAR	8490	100
IQ-LED FL QC I 3x1MM2	33889	264	JASMIN 270-B	29207	122
IQ-LED FL-10W-NW	33880	264	JASMIN 270-G/O	36440	122
IQ-LED FL-10W-NW-SE	33885	264	JASMIN 270-W	23123	122
IQ-LED FL-20W-NW	33881	264	JASMIN 270-W/M	23126	122
IQ-LED FL-20W-NW-SE	33886	264	JASMIN 270-WE	23120	122
IQ-LED FL-30W-NW	33882	264	JASMIN 370-B	29208	122
IQ-LED FL-30W-NW-SE	33887	264	JASMIN 370-G/O	36441	122
IQ-LED FL-50W-NW	33883	264	JASMIN 370-W	23124	122
IQ-LED FL-50W-NW-SE	33888	264	JASMIN 370-W/M	23127	122
IQ-LED FL-90W-NW	33884	264	JASMIN 370-WE	23121	122
IQ-LED G45E14 3,4W-CW	36690	60	JASMIN 470-B	29205	122
IQ-LED G45E14 3,4W-NW	36689	60	JASMIN 470-G/O	36442	122
IQ-LED G45E14 3,4W-WW	36688	60	JASMIN 470-W	23125	122
IQ-LED G45E14 5,9W-CW	36696	60	JASMIN 470-W/M	23128	122
IQ-LED G45E14 5,9W-NW	36695	60	JASMIN 470-WE	23122	122
IQ-LED G45E14 5,9W-WW	36694	60	JASMIN B-W	29209	121

JASMIN C 270-B	36505	105	LCOB 10W/M 12 IP00-NW	37231	83
JASMIN C 270-G/O	36499	105	LCOB 10W/M 12 IP00-WW	37230	83
JASMIN C 270-W/M	36502	105	LCOB 10W/M 12 IP65-NW	37233	83
JASMIN C 370-B	36506	105	LCOB 10W/M 12 IP65-WW	37232	83
JASMIN C 370-G/O	36500	105	LCOB 10W/M 24 IP00-NW	33368	84
JASMIN C 370-W/M	36503	105	LCOB 10W/M 24 IP65-NW	33369	84
JASMIN C 470-B	36507	105	LCOB 8W/M 12 IP00-NW	33366	83
JASMIN C 470-G/O	36501	105	LCOB 8W/M 12 IP00-WW	33364	83
JASMIN C 470-W/M	36504	105	LCOB 8W/M 12 IP65-NW	33367	83
JASMIN G/O-W	36443	121	LCOB 8W/M 12 IP65-WW	33365	83
JASMIN W/M-W	23758	121	LED12 G4-NW	18503	71
JASMIN WE-W	23756	121	LED12 G4-WW	18502	71
JASMIN W-W	23757	121	LEDS-B 4 8W/M IP00-CW	24518	79
JURBA DL-218L	8981	240	LEDS-B 4 8W/M IP00-NW	24517	79
JURBA DL-218O	8980	240	LEDS-B 4 8W/M IP00-WW	24516	79
JUSI E27 B	36271	151	LEDS-B 4 8W/M IP65-CW	24515	79
JUSI E27 W	36270	151	LEDS-B 4 8W/M IP65-NW	24514	79
K LED GU10 6W-CW	36332	67	LEDS-B 4 8W/M IP65-WW	24513	79
K LED GU10 6W-NW	36331	67	LEDS-B 7 2W/M IP00RGB	24530	85
K LED N GU10 6W-WW	36333	67	LEDS-B 7 2W/M IP54RGB	24532	85
KANTI V2LED 12W-NW-SN	27212	261	LEDS-B 7 2W/M IP65RGB	24531	85
KANTI V2LED 12W-NW-W	28950	261	LIEGO 37 B	36534	290
KANTI V2LED 18W-NW-SN	27213	261	LIEGO 89 PEND B	36531	290
KANTI V2LED 18W-NW-W	28951	261	LIEGO 97 B	36530	290
KATRO V2LED 12W-NW-SR	28939	258	LIEGO EL 28 UP B	36532	290
KATRO V2LED 12W-NW-W	28940	258	LIEGO EL 28 UP SE B	36533	290
KATRO V2LED 12W-WW-W	28941	258	LINUS LED 4W-NW	27590	204
KATRO V2LED 18W-NW-SR	28942	258	LINUS LED 7W-NW	27591	204
KATRO V2LED 18W-NW-W	28943	258	LINUS LINK	14977	204
KATRO V2LED 24W-NW-SN	27216	258	LUMKO LED 17,5W NW	37320	114
KATRO V2LED 24W-NW-W	28945	258	LUTO CTX-DS02B-AB	2584	179
KATRO V2LED 6W-NW-W	28946	258	LUTO CTX-DS02B-C/M	2583	179
LI20 16W/M 12 IP00CCT	33317	82	LUTO CTX-DS02B-W	2580	179
LI20 16W/M 24 IP00-NW	33312	81	LUTO CTX-DT02B-C	2591	179
LI20 16W/M 24 IP00-WW	33311	81	LUTO CTX-DT02B-W	2590	179
LI20 16W/M 24 IP65-NW	33315	81	MAH LED HI 19W-NW RYF	22606	222
LI20 16W/M 24 IP65-WW	33314	81	MAH LED HI 26W-NW RYF	22609	222
LI20B 16W/M 24IP00-NW	33356	81	MAH LED HI 38W-NW RYF	22607	222
LI20B 16W/M 24IP00-WW	33355	81	MAH LED HI 48W-NW RYF	22608	222
L48 9W/M 24 IP00-RGBW	33318	86	MAH PLUS-136/4LED/PC	22802	224
L48 9W/M 24 IP65-RGBW	33319	86	MAH PLUS-158/4LED/PC	22803	224
L60 11W/M 12 IP00-CW	33304	80	MAH PLUS-236/4LED/PC	22800	224
L60 11W/M 12 IP00-NW	33303	80	MAH PLUS-236-ABS/PC	18521	225
L60 11W/M 12 IP00-WW	33302	80	MAH PLUS-258/4LED/PC	22801	224
L60 11W/M 12 IP65-CW	33310	80	MAH-LED N 20W-NW/PC	22603	223
L60 11W/M 12 IP65-NW	33309	80	MAH-LED N 40W-NW/PC	22604	223
L60 11W/M 12 IP65-WW	33308	80	MAH-LED N 50W-NW/PC	22605	223
L60B 11W/M 12 IP00-CW	33307	80	MARC DL-60	7015	243
L60B 11W/M 12 IP00-NW	33306	80	MARID JQ-L	8910	328
L60B 11W/M 12 IP00-WW	33305	80	MARIN CT-S80-AB	4710	187
LARATA E27 B	36261	145	MARIN CT-S80-B	32501	187
LARATA E27 W	36260	145	MARIN CT-S80-C	4703	187
LARATA EL-10 B	36263	145	MARIN CT-S80-SN	4704	187
LARATA EL-10 W	36262	145	MARIN CT-S80-W	32500	187
LART EL-160-GR	29832	277	MATEO ES DLP-150-B	32930	253
LART EL-260-GR	29833	277	MATEO ES DLP-150-W	32931	253
LAURIN EL-10 B	29121	132	MATEO ES DLP-250-B	32932	253
LAURIN EL-10 W	29120	132	MATEO ES DLP-250-W	32933	253
LAURIN EL-21 B	29123	132	MEBA 4LED 120 IP54 PC	33895	226
LAURIN EL-21 W	29122	132	MEBA 4LED 150 IP54 PC	33896	226
LAURIN EL-31 B	29125	132	MEBA 4LED 2X120 OP PS	26964	227
LAURIN EL-31 W	29124	132	MEBA 4LED 2X120 PS	26961	227
LAURIN EL-30 B	29127	132	MEBA 4LED 2X150 OP PS	26965	227
LAURIN EL-30 W	29126	132	MEBA 4LED 60 IP54 PC	33894	226
LAURIN EL-40 B	29129	132	MEBA LED 12-20W NW/WW	33890	227
LAURIN EL-40 W	29128	132	MEBA LED 20W IP54 NW	33892	226
LAVEN 50 GR	36546	287	MEBA LED 22-40W NW/WW	33891	227
LAVEN 80 GR	36545	287	MEBA LED 40W IP54 NW	33893	226
LAVEN EL 25 GR	36548	287	MEFIS LED B-NW	32497	200
LAVEN EL 28 SE-GR	36547	287	MEFIS LED W-NW	32495	200
LCO B 10W/M 24 IP00-CW	33353	84	MERA LED 10W NW	29211	203
LCO B 10W/M 24 IP00-WW	33351	84	MERA LED 15W NW	29212	203
LCO B 10W/M 24 IP65-CW	33354	84	MERA LED 20W NW	29213	203
LCO B 10W/M 24 IP65-WW	33352	84	MERA LED 5W NW	29210	203

MERA LED PP	29214	203	OFIS S LED	xxx	24
MERGE ADJ-O	23451	331	OGIVA D35 GR	27001	106
MERGE JQ-L	7690	328	ONTEC C C160NMATW	33849	347
MERGE JQ-O	7691	330	ONTEC C C160NMSTW	33868	347
MERGE MW-L	23453	331	ONTEC C M160NMATW	33847	347
MERGE-WT-O-W	37370	325	ONTEC C M160NMSTW	33858	347
MILENO EL-10 ASR-AN	29111	138	ONTEC G E1E 301 M STW	28976	347
MILENO EL-10 B-AG	29110	138	ONTEC G E1E180MATW	28979	347
MILENO EL-2I ASR-AN	29115	138	ONTEC R C1 60N M STW	33826	348
MILENO EL-2I B-AG	29114	138	ONTEC R M1 60N M ATW	33850	348
MILENO EL-3I ASR-AN	29117	138	ONTEC R M1 60N M STW	29098	348
MILENO EL-3I B-AG	29116	138	ONTEC R M2 302 M ATW	33851	348
MILENO EL-3O ASR-AN	29113	138	ONTEC R M2 302 M ATW	33852	348
MILENO EL-3O B-AG	29112	138	ONTEC S 20M1X AT W	27529	344
MILENO EL-4I ASR-AN	29119	138	ONTEC S 20M1X ST W	27528	344
MILENO EL-4I B-AG	29118	138	ONTEC S C1302MATW	33842	344
MILO 7040T	70522	245	ONTEC S C1302MATWCLD	28977	344
MILO 7040T/P	70523	245	ONTEC S C1302MSTW	33862	344
MILO 7040T/P-B	8092	245	ONTEC S C160NMATW	28978	344
MINI BORD DLP-50-B	28783	164	ONTEC S C2105MATW	33843	344
MINI BORD DLP-50-W	28782	164	ONTEC S F2105MATW	33844	344
MINI GORD DLP-50-B	28781	163	ONTEC S F2105MSTW	33864	344
MINI GORD DLP-50-W	28780	163	ONTEC S M1180MATW	28973	344
MINI RITI GU10 B/B	27578	163	ONTEC S M1180MSTW	27527	344
MINI RITI GU10 B/G	27575	163	ONTEC S M2102MATWCLD	33819	344
MINI RITI GU10 B/W	27577	163	ONTEC S M2302MATW	36382	344
MINI RITI GU10 W/G	27576	163	ONTEC S M2302MATWCLD	33818	344
MINI RITI GU10 W/W	27579	163	ONTEC S M2302MSTW	36381	344
MODv2 LED 12W-NW	29301	78	ONTEC S M2302MSTWCLD	33856	344
MODv2 LED 12W-WW	29300	78	ONTEC S M5105MATW	33840	344
MODv2 LED 19W-NW	29303	78	ONTEC S M5105MSTW	33855	344
MODv2 LED 19W-WW	29302	78	ONTEC S M5305MATW	33841	344
MORO N IG-20	18194	283	ONTEC S W1302MATW	33845	344
MORTA B CT-DSL50-B	22110	174	ONTEC S W1302MATWCLD	33810	344
MORTA B CT-DSL50-SR	22112	174	ONTEC S W1302MSTW	33865	344
MORTA B CT-DSO50-B	22116	174	ONTEC S W1302MSTWCLD	33866	344
MORTA B CT-DSO50-SR	22117	174	ONTEC S W2105MATWCLD	33846	344
MORTA CT-DSL50-B	18510	173	ONTECSC1302MATW	27652	344
MORTA CT-DSL50-SR	18512	173	OPRAWA DWUSTRONNA OSO	33829	345
MORTA CT-DSO50-B	19440	173	ORISA LED WW B	37395	141
MORTA CT-DSO50-SR	19442	173	ORISA LED WW W	37394	141
MORTA CT-DTL50-B	26719	173	ORTE LED 18W-NW-O	29160	237
MORTA CT-DTL50-SR	26718	173	ORTE LED 18W-NW-O-SE	29162	237
MORTA CT-DTO50-B	26717	173	ORTE LED 24W-NW-O	29161	237
MORTA CT-DTO50-SR	26716	173	ORTE LED 24W-NW-O-SE	29163	237
MORTA OCT-B	26715	174	OYO 5LED-CW	8121	188
MORTA OCT-SR	26714	174	PEVO 50 GR	36551	286
NASTO 2SOC FR B	36586	302	PEVO 80 GR	36550	286
NAVI CTX-DS10-B	25990	179	PEVO EL 25 GR	36552	286
NAVI CTX-DT10-B	25991	179	PICTO ONTEC G D2	27483	349
NAVI CTX-DT10-C/M	2553	179	PICTO ONTEC G D3	27484	349
NAVI CTX-DT10-W	2550	179	PICTO ONTEC G D5	27482	349
NEDIA E14 B	34475	151	PICTO ONTEC G D7	27488	349
NEDIA E14 W	34476	151	PICTO ONTEC G D8	27485	349
NEON END CAP	37239	96	PICTO ONTEC G DB	27499	349
NEON END CAP HOLE	37238	96	PICTO ONTEC G DC	27500	349
NEON LED12W/M IP65-BL	37237	96	PICTO ONTEC G F1	27497	349
NEON LED12W/M IP65-CW	37236	96	PICTO ONTEC G F2	27498	349
NEON LED12W/M IP65-NW	37235	96	PICTO ONTEC G W1	27490	349
NEON LED12W/M IP65-WW	37234	96	PICTO ONTEC S D1	27509	350
NEON MOUNTING CLIP	37229	96	PICTO ONTEC S D2	27506	350
NESTA DSL-C	26747	177	PICTO ONTEC S D3	27507	350
NESTA DSL-C/M	26748	177	PICTO ONTEC S D4	27512	350
NESTA DTL-C	26751	177	PICTO ONTEC S D5	27505	350
NESTA DTL-C/M	26752	177	PICTO ONTEC S D6	27510	350
NOTUS 3 EVG 218 NT	19733	218	PICTO ONTEC S D7	27511	350
NOTUS 3 EVG 236 NT	19732	218	PICTO ONTEC S D8	27508	350
NOTUS 3 EVG 418 NT	19731	218	PICTO ONTEC S DB	27522	350
NOTUS 3WS EVG 236 NT	25712	218	PICTO ONTEC S DC	27523	350
NOTUS 3WS EVG 418 NT	25711	218	PICTO ONTEC S F1	27520	350
NOTUS 4LED 218 NT	22674	219	PICTO ONTEC S W1	27513	350
NOTUS 4LED 236 NT	22672	219	PICTO ONTEC S W2	27514	350
NOTUS 4LED 418 NT	22671	219	PIN W\US	2186	339

PIRES DL-600	8810	241	REGIS 4LED OPAL 418PT	19736	217
PIRES DL-600 NS	8811	241	REKA LED EL 7W-L-GR	28990	274
PIRES ECO DL-250	19000	241	REKA LED EL 7W-L-W	28992	274
PIRES ECO DL-250 NS	19001	241	REKA LED EL 7W-O-GR	28991	274
PIXA KT-40-B	19301	152	REKA LED EL 7W-O-W	28993	274
PIXA KT-40-W	19300	152	REMI LED GU 10-CW	33082	69
PLAFMIN O	25690	244	REMI LED GU 10-NW	33080	69
POWELED P 12V 100W	28961	335	REMI LED GU 10-WW	33081	69
POWELED P 12V 150W	28963	335	REMOTE CCT	22145	87
POWELED P 12V 200W	28965	335	REMOTE MONO	22144	87
POWELED P 12V 30W	26810	335	REMOTE RGBW	22146	87
POWELED P 12V 60W	26811	335	REXAR LED B	33071	155
POWELED P 24V 100W	28962	335	REXAR LED W	33070	155
POWELED P 24V 150W	28964	335	RIFA LED 17,5W NW B/G	36464	118
POWELED P 24V 200W	28966	335	RIFA LED 17,5W NW B/W	36462	118
POWELED P 24V 30W	26815	335	RIFA LED 17,5W NW N1	36468	118
POWELED P 24V 60W	26816	335	RIFA LED 17,5W NW N2	35508	118
PREDA LED B	35780	154	RIFA LED 17,5W NW W/W	36460	118
PREDA LED W	35781	154	RIFA LED 17,5W WW B/G	36465	118
PRESO 30 GR	36542	288	RIFA LED 17,5W WW B/W	36463	118
PRESO 50 GR	36541	288	RIFA LED 17,5W WW N1	36469	118
PRESO 80 GR	36540	288	RIFA LED 17,5W WW N2	35509	118
PRESO EL 18 GR	36543	288	RIFA LED 17,5W WW W/W	36461	118
PROFILO B	19161	88	RIFA LED 17,5W WW W/W	36466	118
PROFILO B 2m	26540	88	RIFA LED 17,5W WW GR/G	36467	118
PROFILO C	19162	89	RIFA LED 17,5W WW GR/G	36467	118
PROFILO C 2m	26541	89	RITI GU10 B/B	27567	111
PROFILO D	19163	90	RITI GU10 B/G	27571	111
PROFILO D 2m	26542	90	RITI GU10 W/G	27570	111
PROFILO F	26552	91	RITI GU10 W/W	27569	111
PROFILO F 2m	26553	91	ROGER DL-2LED6	7281	281
PROFILO G	26558	92	ROGER DL-LED12	7280	281
PROFILO G 2m	26559	92	ROLF JQ-L	8820	329
PROFILO H	26560	93	ROLF JQ-O	8821	330
PROFILO H 2m	26561	93	ROLF MINI JQ-L	8822	329
PROFILO J	26544	94	ROLSO LED IP44 15W-NW	26700	189
PROFILO J 2M	26545	94	ROPE-NT 150	7870	218 / 219
PROFILO J-W	26546	94	ROPE-NT 150 SINGLE	7871	218 / 219
PROFILO J-W 2M	26547	94	ROUNDA V2LED12W-NW-SR	28930	256
PROFILO K	26548	95	ROUNDA V2LED12W-NW-W	28931	256
PROFILO K 2m	26549	95	ROUNDA V2LED12W-WW-W	28932	256
PROFILO K-W	26550	95	ROUNDA V2LED18W-NW-SR	28933	256
PROFILO K-W 2m	26551	95	ROUNDA V2LED18W-NW-W	28934	256
PSR 100	25591	213	ROUNDA V2LED18W-WW-W	28935	256
QULES AC O-B	26306	187	ROUNDA V2LED24W-NW-SN	27220	256
QULES AC O-C/M	26304	187	ROUNDA V2LED24W-NW-W	28936	256
QULES AC O-W	26303	187	ROUNDA V2LED24W-WW-W	33524	256
RADAN CT-DSO50	7362	181	ROUNDA V2LED6W-NW-SN	27221	256
RADAN CT-DTOS0	7360	181	ROUNDA V2LED6W-NW-W	28937	256
RAIBO E27 B	36280	150	ROUNDA V2LED6W-WW-B	33562	256
RAIBO E27 BL	36282	150	ROUNDA V2LED6W-WW-W	28938	256
RAIBO E27 GN	36284	150	S A60 11,5WE27 RGB CCT	33642	36
RAIBO E27 PK	36285	150	S A60 7W E27 CCT	33640	36
RAIBO E27 W	36281	150	S A60 9W E27 RGB CCT	33641	36
RAIBO E27 Y	36283	150	S AD GN 10A PM	33701	318
RANGO MINI R7S SMD-WW	15099	77	S AD GN SCH 10A PM	33703	318
RANGO R7S SMD-WW	15098	77	S C37 4,9W E14 RGB CCT	33644	36
RAPID HI v2 E27-NW	22954	49	S GU10 4,7W RGB CCT	33643	36
RAPID HI v2 E27-WW	22955	49	S SENSOR ON\OFF INT	34942	316
RAPID MAXX v2 E27-NW	22948	49	S SENSOR PIR INT 10M	34940	316
RAPID MAXX v2 E27-WW	22949	49	S SENSOR W INT	34941	317
RAPID PRO v2 E27-NW	22946	49	S SWITCH G DOOR	34950	319
RAPID PRO v2 E27-WW	22947	49	S SWITCH ON\OFF	34948	319
RAPID v2 E27-NW	22944	49	S SWITCH SHUTTER	34949	319
RAPID v2 E27-WW	22945	49	SABIK LED AC-WW	23802	198
REF ATL1-18W-S15	33140	305	SABIK LED B-NW	29852	198
REF ATL1-18W-S36	33141	305	SABIK LED B-WW	29853	198
REF ATL1-30W-S15	33142	305	SABIK LED CW	23110	198
REF ATL1-30W-S36	33143	305	SABIK LED PIR B-NW	29858	198
REGIS 3 EVG 418 PT	19730	216	SABIK LED WW	23108	198
REGIS 3 OPAL 418 PT	19734	216	SABIK MINI LED B-NW	29854	198
REGIS 3WS EVG 418 PT	25710	216	SABIK MINI LED B-WW	29855	198
REGIS 3WS OPAL 418 PT	25713	216	SABIK MINI LED CW	23111	198
REGIS 4LED 418 PT	22673	217	SABIK MINI LED NW	32490	198
			SABIK MINI LED WW	23109	198

SANGA DL-100	8050	246	SHADE-U H-W 2m	26585	93
SANI IP44 DSO-B	29240	107	SIGO R39 LED E14-NW	22734	76
SANI IP44 DSO-SN	29242	107	SIGO R39 LED E14-WW	22733	76
SANI IP44 DSO-W	29241	107	SIGO R50 LED E14-NW	22736	76
SANSO LED 15W-NW-SE	26520	243	SIGO R50 LED E14-WW	22735	76
SEALINGS G	26602	92	SIGO R63 LED E27-NW	22738	76
SEIDY CT-DTL250-B/M	19459	166	SIGO R63 LED E27-WW	22737	76
SEIDY CT-DTL250-W/M	19455	166	SIMEN DSL B/G/B	29134	168
SEIDY CT-DTL50-AL	18281	166	SIMEN DSL B/W/B	29131	168
SEIDY CT-DTL50-B	18289	166	SIMEN DSL SR/B/B	29132	168
SEIDY CT-DTL50-B/M	19458	166	SIMEN DSL W/G/W	29135	168
SEIDY CT-DTL50-W/M	19454	166	SIMEN DSO B/G	29137	168
SEIDY CT-DTO50-AL	18280	166	SIMEN DSO B/W	29138	168
SEIDY CT-DTO50-B	18288	166	SIMEN DSO G/W	29142	168
SEIDY CT-DTO50-B/M	19457	166	SIMEN DSO W/B	29139	168
SEIDY CT-DTO50-W/M	19456	166	SIMEN DSO W/G	29140	168
SELTO 50 B	36556	289	SLICK JQ-L-B	8391	325
SELTO 80 B	36555	289	SLICK JQ-L-W	8390	325
SELTO EL 23 B	36557	289	SOLA LED AC-WW	23804	199
SEMPRA EL-II B-SR	33091	134	SOLA LED B-NW	27558	199
SEMPRA EL-II W-SR	33090	134	SOLA LED B-WW	27559	199
SEMPRA EL-2I B-SR	33093	134	SOLA LED NW	32491	199
SEMPRA EL-2I W-SR	33092	134	SOLA LED WW	23100	199
SEMPRA EL-3I B-SR	33095	134	SOLN LED 17,5W NW B/G	37324	116
SEMPRA EL-3I W-SR	33094	134	SONDA II EL-10 B	34920	128
SEMPRA EL-4I B-SR	33097	134	SONDA II EL-10 W	34921	128
SEMPRA EL-4I W-SR	33096	134	SONDA II EL-2I B	34922	128
SENSQUARE-B	37369	324	SONDA II EL-2I W	34923	128
SENSQUARE-W	37368	324	SONDA II EL-3I B	34924	128
SENTO	26820	332	SONDA II EL-3I W	34925	128
SENTO-O-WT-B	37367	324	SONDA II EL-30 B	34926	128
SENTO-O-WT-W	37366	324	SONDA II EL-30 W	34927	128
SENZO	26821	332	SONDA II EL-40 B	34928	128
SET105-K	1426	336	SONDA II EL-40 W	34929	128
SET60-K	1425	336	SONOR GU10 CO-B WW	24362	107
SHADE B/F-FR	26568	88	SOREN L-BL /LED	24414	171
SHADE B/F-FR	26568	91	SOREN L-SR CW /LED	24417	171
SHADE B/F-FR 2M	26570	88	SOREN L-SR WW /LED	24413	171
SHADE B/F-FR 2M	26570	91	SOREN O-BL /LED	24411	171
SHADE B/F-W	26569	88	SOREN O-SR CW /LED	24416	171
SHADE B/F-W	26569	91	SOREN O-SR WW /LED	24410	171
SHADE B/F-W 2M	26571	88	SPAG C B/G AWY	27324	162
SHADE B/F-W 2M	26571	91	SPAG D B/G AWY	27326	162
SHADE C/D/E/I-FR	26572	89	SPAG D W/G AWY	27327	162
SHADE C/D/E/I-FR	26572	90	SPAG S B/G AWY	27322	162
SHADE C/D/E/I-FR 2M	26573	89	SPN BRAVO S/P 12030	28505	213
SHADE C/D/E/I-FR 2M	26573	90	SPN BRAVO S/P 60-62	28504	213
SHADE C/D/E/I-W	26574	89	SPN PANEL 120	37336	209
SHADE C/D/E/I-W	26574	90	SPN PANEL 120	37336	211
SHADE C/D/E/I-W 2M	26575	89	SPN PANEL 60-62	37335	209
SHADE C/D/E/I-W 2M	26575	90	SPN PANEL 60-62	37335	211
SHADE CK C/D/E/I-FR	26576	89	SQMOTION-B	37361	322
SHADE CK C/D/E/I-FR	26576	90	SQMOTION-W	37360	322
SHADE CK C/D/E/I-FR2M	26577	89	ST 45 LED 0,5W E27-BL	26039	50
SHADE CK C/D/E/I-FR2M	26577	90	ST 45 LED 0,5W E27-GR	26048	50
SHADE CK C/D/E/I-W	26578	89	ST 45 LED 0,5W E27-NW	26046	50
SHADE CK C/D/E/I-W	26578	90	ST 45 LED 0,5W E27-RE	26049	50
SHADE CK C/D/E/I-W 2M	26579	89	ST 45 LED 0,5W E27-WW	26045	50
SHADE CK C/D/E/I-W 2M	26579	90	ST64 A 4W-SW	26047	51
SHADE CK G	26580	92	STAN GP	4864	339
SHADE CK G 2M	26581	92	STATO N LED 30W-B	29222	267
SHADE J/K-FR	26564	94	STATO N LED 50W-B	29223	267
SHADE J/K-FR	26564	95	STER TS-MF1	1001	334
SHADE J/K-FR 2m	26566	94	STIVI LED 24W-NW-O	35000	236
SHADE J/K-FR 2m	26566	95	STIVI LED 24W-NW-O-SE	35001	236
SHADE J/K-W	26565	94	STIVI LED 36W-NW-O	35002	236
SHADE J/K-W	26565	95	STIVI LED 36W-NW-O-SE	35003	236
SHADE J/K-W 2m	26567	94	STOBI DLP 250-B	26832	110
SHADE J/K-W 2m	26567	95	STOBI DLP 250-W	26833	110
SHADE-O H-W	26586	93	STOBI DLP 50-B	26830	110
SHADE-O H-W 2m	26587	93	STOBI DLP 50-W	26831	110
SHADE-U H-FR	26582	93	STONO 20 N	24654	296
SHADE-U H-FR 2m	26583	93	STONO 30	24651	296
SHADE-U H-W	26584	93	STONO 390 N	36591	296

INDEX ALPHABÉTIQUE
INDICE ALFABETICO

STONO 490 N	36592	296	TEAR N CON-I FLEX W	33252	310
STONO 585 N	36593	296	TEAR N CON-I W	33240	310
STONO 780 N	36594	296	TEAR N CON-L LR-B	33245	310
STOPPER B	19181	88	TEAR N CON-L LR-W	33244	310
STOPPER C	19182	89	TEAR N CON-L RL-B	33243	310
STOPPER D	19183	90	TEAR N CON-L RL-W	33242	310
STOPPER F	26590	91	TEAR N CON-T LLR-B	33265	310
STOPPER G	26592	92	TEAR N CON-T LLR-W	33264	310
STOPPER J	26588	94	TEAR N CON-T LRR-B	33263	310
STOPPER J-W	26605	94	TEAR N CON-T LRR-W	33262	310
STOPPER K	26589	95	TEAR N CON-T RLL-B	33251	310
STOPPER K-W	26606	95	TEAR N CON-T RLL-W	33250	310
STOPPER-O H	26594	93	TEAR N CON-T RRL-B	33249	310
STOPPER-U H	26593	93	TEAR N CON-T RRL-W	33248	310
STRETON LED 100W NW	36231	270	TEAR N CON-X B	33247	310
STRETON LED 150W NW	36232	270	TEAR N CON-X W	33246	311
STRETON LED 200W NW	36233	270	TEAR N EPLUG B	33237	311
STRETON LED 20W NW	36228	270	TEAR N EPLUG W	33236	311
STRETON LED 40W NW	36229	270	TEAR N ICON-I B	33239	311
STRETON LED 60W NW	36230	270	TEAR N ICON-I W	33238	311
SUZI HR-60-B	7151	153	TEAR N PADAPTOR-B	33267	313
SUZI HR-60-BL	7152	153	TEAR N PADAPTOR-W	33266	313
SUZI HR-60-PK	7153	153	TEAR N PCON L-B	33261	311
SUZI HR-60-SR	7150	153	TEAR N PCON L-W	33260	311
SUZI HR-60-W	7154	153	TEAR N PCON R-B	33235	311
T-1\10-B	1257	351	TEAR N PCON R-W	33234	311
T-1\20-B	1271	351	TEAR N RC-CON-I B	35795	311
T-1\20-BL	1275	351	TEAR N RC-CON-I W	35794	311
T-1\20-GN	1274	351	TEAR N RC-CON-L B	35793	312
T-1\20-MIX	1283	351	TEAR N RC-CON-L W	35792	311
T-1\20-W	1276	351	TEAR N RC-CON-T B	35797	312
T5-13W 4000K/65	12716	100	TEAR N RC-CON-T W	35796	312
T5-14W 4000K/82	12717	100	TEAR N RC-CON-X B	35799	312
T5-8W 4000K/65	12715	100	TEAR N RC-CON-X W	35798	312
T8 18W/840 NW	19921	101	TEAR N RCLIP-B	35803	312
T8 18W/865 CW	19922	101	TEAR N RCLIP-W	35802	312
T8 36W/840 NW	19924	101	TEAR N RC-PCON B	35791	311
T8 36W/865 CW	19925	101	TEAR N RC-PCON W	35790	311
T8 LED GLASSv3 18W-CW	26065	74	TEAR N R-TR 2M-B	35801	311
T8 LED GLASSv3 18W-NW	26064	74	TEAR N R-TR 2M-W	35800	311
T8 LED GLASSv3 22W-CW	26059	74	TEAR N SCLAMP B	33255	311
T8 LED GLASSv3 22W-NW	26058	74	TEAR N SCLAMP W	33254	311
T8 LED GLASSv3 9W-CW	26063	74	TEAR N SKIT B	33257	311
T8 LED GLASSv3 9W-NW	26062	74	TEAR N SKIT W	33256	311
T8 LED GLASSv4 18W-CW	33213	75	TEAR N TR 1M-B	33231	311
T8 LED GLASSv4 18W-NW	33212	75	TEAR N TR 1M-W	33230	311
T8 LED GLASSv4 24W-CW	33215	75	TEAR N TR 2M-B	33233	311
T8 LED GLASSv4 24W-NW	33214	75	TEAR N TR 2M-W	33232	311
T8 LED GLASSv4 9W-CW	33211	75	TEDI MAXX LED GU 10-CW	23413	69
T8 LED GLASSv4 9W-NW	33210	75	TEDI MAXX LED GU 10-NW	23414	69
T8 LED GLASSv5 12W-CW	33217	75	TEDI MAXX LED GU 10-WW	23412	69
T8 LED GLASSv5 12W-NW	33216	75	TERRA LED AC-WW	23806	197
T8 LED STARTER	26069	74	TERRA LED B-NW	26848	197
T8LED GLASSv3T 18W NW	26068	74	TERRA LED B-WW	26849	197
TANO G4 SMD-NW	14937	71	TERRA LED CW	23104	197
TANO G4 SMD-WW	14936	71	TERRA LED PIR B-NW	29860	197
TAVO FRAME DL 12W	36522	254	TERRA LED PIR B-WW	29861	197
TAVO FRAME DL 18W	36523	254	TERRA LED W-CW	26843	197
TAVO FRAME DO 12W	36520	254	TERRA LED WW	23102	197
TAVO FRAME DO 18W	36521	254	TERRA LED W-WW	26842	197
TAVO LED DL 12W-NW	36517	254	TESON AL-DSL50	7373	181
TAVO LED DL 18W-NW	36518	254	TESON AL-DSO50	7372	181
TAVO LED DL 24W-NW	36519	254	TESON AL-DTL50	7371	181
TAVO LED DL 5W-NW	36515	254	TIBERI PRO 20W-940-B	35671	250
TAVO LED DL 9W-NW	36516	254	TIBERI PRO 20W-940-W	35670	250
TAVO LED DO 12W-NW	36512	254	TIBERI PRO 30W-940-B	35673	250
TAVO LED DO 18W-NW	36513	254	TIBERI PRO 30W-940-W	35672	250
TAVO LED DO 24W-NW	36514	254	TIBERI PRO 40W-940-B	35675	250
TAVO LED DO 5W-NW	36510	254	TIBERI PRO 40W-940-W	35674	250
TAVO LED DO 9W-NW	36511	254	TIBERI PRO NT20W-940B	35677	251
TAXI SMD L C/M-NW	26461	279	TIBERI PRO NT20W-940W	35676	251
TAXI SMD P C/M-NW	26463	279	TIBERI PRO NT30W-940B	35679	251
TEAR N CON-I B	33241	310	TIBERI PRO NT30W-940W	35678	251
TEAR N CON-I FLEX B	33253	310	TINY BORD DTO-B	37165	164

INDEX ALPHABÉTIQUE
INDICE ALFABETICO

TINY BORD DTO-B/G	37166	164	VARSO LED 24W-NW-L-SE	26983	234
TINY BORD DTO-W	37167	164	VARSO LED 24W-NW-O	26445	234
TINY BORD DTO-W/G	37168	164	VARSO LED 24W-NW-O-SE	26984	234
TOMI LED5W MR16-CW	22705	76	VARSO LED 24W-WW-O	26444	234
TOMI LED5W MR16-WW	22704	76	VIDI CTC-5514-B	25995	180
TOMI LED7W MR16-CW	22707	76	VIDI CTC-5514-C	2791	180
TOMI LED7W MR16-WW	22706	76	VIDI CTC-5514-C/M	2793	180
TOMIv2 1,2W GU10-CW	34960	68	VIDI CTC-5514-W	2790	180
TOMIv2 1,2W GU10-NW	34961	68	VIDI CTC-5515-B	25996	180
TOMIv2 1,2W GU10-WW	34962	68	VIDI CTC-5515-C	2781	180
TOMIv2 2,9W GU10-CW	34963	68	VIDI CTC-5515-C/M	2783	180
TOMIv2 2,9W GU10-NW	34964	68	VIDI CTC-5515-W	2780	180
TOMIv2 2,9W GU10-WW	34965	68	VIMO 50 B	34984	291
TOMIv2 4,9W GU10-CW	34966	68	VIMO 50 BR	34985	291
TOMIv2 4,9W GU10-NW	34967	68	VIMO 50 SE-B	34986	291
TOMIv2 4,9W GU10-WW	34968	68	VIMO 50 SE-BR	34987	291
TOMIv2 6,5W GU10-CW	34969	68	VIMO 80 B	34988	291
TOMIv2 6,5W GU10-NW	34970	68	VIMO 80 BR	34989	291
TOMIv2 6,5W GU10-WW	34971	68	VIMO EL 27 B	34980	291
TONIL LED B	32520	143	VIMO EL 27 BR	34981	291
TONIL LED W	32521	143	VIMO EL 27 SE-B	34982	291
TP SLIM LED 40W-NW	27115	221	VIMO EL 27 SE-BR	34983	291
TP SLIM LED 50W-NW	27116	221	VORA EL 20 GR	36566	299
TP SLIM TW LED 40W-NW	27117	221	VORA SP 20 GR	36565	299
TP SLIM TW LED 50W-NW	27118	221	WIR ZL100	70961	337
TP STRONG LED 48W-NW	33170	220	WIR ZL120	70962	337
TP STRONG LED 75W-NW	33171	220	XARD DL-40	7195	283
TP STRONG LED 90W-NW ()	33172	220	XLED A60 10W-NW	29606	44
TRIBIS II L AB	23843	184	XLED A60 10W-NW-M	29616	46
TRIBIS II L B	23853	184	XLED A60 10W-WW	29605	44
TRIBIS II L C	23844	184	XLED A60 10W-WW-M	29615	46
TRIBIS II L C/M	23845	184	XLED A60 4,5W-NW-M	29608	46
TRIBIS II L W	23849	184	XLED A60 4,5W-WW	29600	44
TRIBIS II O AB	23846	184	XLED A60 4,5W-WW-M	29607	46
TRIBIS II O B	23855	184	XLED A60 4W-SW	33516	54
TRIBIS II O C	23847	184	XLED A60 7W-CW	29603	44
TRIBIS II O C/M	23848	184	XLED A60 7W-NW	29602	44
TRIBIS II O W	23854	184	XLED A60 7W-NW-M	29610	46
TUNA MINI N	8091	247	XLED A60 7W-WW	29601	44
TUNA S1101-W	4260	247	XLED A60 7W-WW-M	29609	46
TURK DL-60	7025	247	XLED A60 8W-NW-M	29613	46
TURRO LED 3X15W-NW	18983	280	XLED A60 8W-WW	29604	44
TWISTER AOL100B	70926	337	XLED A60 8W-WW-M	29612	46
TWISTER AOL100T	70953	337	XLED A60 B22 10W-CW-M	33109	48
TWISTER AOL120B	70956	337	XLED A60 B22 10W-WW-M	33108	48
TWISTER AOL120T	70960	337	XLED A60 B22 7W-CW-M	33103	48
TYBIA LED 38W-NW	24640	239	XLED A60 B22 7W-WW	33100	48
TYBIA LED 38W-NW B	24642	239	XLED A60 B22 7W-WW-M	33102	48
TYBIA LED 38W-NW-SE	24641	239	XLED A60 M 7W-NW	33515	52
TYBIA LED 38W-NW-SE B	24643	239	XLED A60 M 7W-WW	33514	52
TYBIA M 25W-NW B	24645	239	XLED A70 18W-NW	29649	45
TYBIA M 25W-NW GY	24644	239	XLED A70 18W-WW	29648	45
TYBIA M 25W-NW-SE B	24647	239	XLED C35 E14 6W-NW	35273	58
TYBIA M 25W-NW-SE GY	24646	239	XLED C35 E14 6W-WW	35272	58
UCHW PODT OS S2 S3 IT	33830	345	XLED C35E14 2,5W-WW	29617	58
ULOV LED DIM WW W	37396	140	XLED C35E14 4,5W-NW	29619	58
USTI SP 1X7 GR	36561	298	XLED C35E14 4,5W-NW-M	29621	58
USTI SP 2X7 GR	36560	298	XLED C35E14 4,5W-WW	29618	58
VADRA 16L-UP	29010	293	XLED C35E14 4,5W-WW-M	29620	58
VADRA 21L-UP SE	29011	293	XLED C35E14 6W-NW-M	29623	58
VADRA 50	29012	293	XLED C35E14 6W-WW-M	29622	58
VADRA 80	29013	293	XLED C35E27 6W-NW-M	29647	58
VAND LED 17,5W NW B	37327	117	XLED C35E27 6W-WW-M	29646	58
VAND LED 17,5W NW W	37326	117	XLED C35T 2,5W-SW	29641	54
VARSO HI 36W-NW-L	26449	234	XLED EX A60 4W-NW	36244	43
VARSO HI 36W-NW-O	26448	234	XLED EX A60 4W-WW	36243	43
VARSO HI 36W-NW-O-SE	26985	234	XLED EX A60 5W-NW	36246	43
VARSO LED 18W-NW-L	26443	234	XLED EX A60 5W-WW	36245	43
VARSO LED 18W-NW-L-SE	26980	234	XLED EX A60 7,2W-NW	36248	43
VARSO LED 18W-NW-O	26441	234	XLED EX A60 7,2W-WW	36247	43
VARSO LED 18W-NW-O-SE	26981	234	XLED G125 11W-NW	33512	53
VARSO LED 18W-WW-O	26440	234	XLED G125 11W-WW	33511	53
VARSO LED 24W-NW-L	26447	234	XLED G125 4W-SW	33519	54

XLED G125 7W-WW	29638	53
XLED G45 E14 4,5W-WW	29624	62
XLED G45 E14 6W-NW	35277	62
XLED G45 E14 6W-NW-M	29629	63
XLED G45 E14 6W-WW	35276	62
XLED G45 E14 6W-WW-M	29628	63
XLED G45 E27 4,5W-WW	29625	62
XLED G45 E27 6W-NW	35275	62
XLED G45 E27 6W-NW-M	29633	63
XLED G45 E27 6W-WW	35274	62
XLED G45 E27 6W-WW-M	29632	63
XLED G45E14 4,5W-NW-M	29627	63
XLED G45E14 4,5W-WW-M	29626	63
XLED G45E27 4,5W-NW-M	29631	63
XLED G45E27 4,5W-WW-M	29630	63
XLED G95 4W-SW	33518	54
XLED G95 7W-WW	36241	52
XLED G95S 5,8W-NW	36242	52
XLED HP D46E40 38W-NW	37347	98
XLED HP D90E27 26W-NW	37346	98
XLED ST64 4W-SW	33517	54
XLED ST64 7W-WW	29637	51
XLED ST64C 7W-NW	33513	51
XLED W A60 8,5W-WW	37380	55
XLED W C35E14 4,5W-WW	37382	55
XLED W G45E14 4,5W-WW	37383	55
XLED W ST 64 7W-WW	37381	55
XLEDA60 7W-NW-STEPPDIM	29635	47
XLEDA60 7W-WW-STEPPDIM	29634	47
XLEDEX C35E14 3,8W-NW	37341	57
XLEDEX C35E14 3,8W-WW	37340	57
XLEDEX G45E14 3,8W-NW	37343	61
XLEDEX G45E14 3,8W-WW	37342	61
XLEDEX G45E27 3,8W-NW	37345	61
XLEDEX G45E27 3,8W-WW	37344	61
XLEDI M A60 B22 12W-CW	37244	48
XLEDI M A60 B22 12W-WW	37243	48
XLEDI M A60 E27 11W-CW	37242	47
XLEDI M A60 E27 11W-NW	37241	47
XLEDI M A60 E27 11W-WW	37240	47
XLEDIM C35E14 5,9W-WW	35278	57
ZARA HR-40-B	7561	153
ZARA HR-40-SR	7560	153
ZARA HR-40-W	7564	153
ZARK KRT \2-1	2180	340
ZARK KRW -3	2181	340
ZEPO LFD-T02/S-B	36632	202
ZEPO LFD-T02/S-C/M	4386	202
ZEPO LFD-T02/S-W	36633	202
ZEPO LFD-T02-B	36630	202
ZEPO LFD-T02-C/M	4381	202
ZEPO LFD-T02-W	36631	202
ZEST MON OS010 W	28974	345
ZEST MONT OS05	33871	345
ZEST MONT OS205	33877	345
ZEST MONT S20 FLAGA	33876	345
ZEST POD OR00 B	28985	345
ZEW EL-235J-B	22440	276
ZEW EL-235J-GR	22442	276
ZEW EL-235U-B	22441	276
ZEW EL-235U-GR	22443	276
ZONA FLAT-W	23452	327
ZONA JQ-37-B	463	327
ZONA JQ-37-W	464	327
ZONA MINI WT-W	37365	323
ZONA MINI-W	37364	323
ZUBI LED 4W E14-NW	24529	70
ZUBI LED 4W E14-WW	24528	70
ZUBI LED 4W G9-CW	24519	70
ZUBI LED 4W G9-NW	24527	70
ZUBI LED 4W G9-WW	24526	70

INDEX PAR CODE

INDICE PER CODICE PRODOTTO

276	BERGAD-7L	282	7691	MERGEJQ-O	330
402	HLDR-G210	343	7870	ROPE-NT 150	218
405	HLDR-R7S	343	7870	ROPE-NT 150	219
460	ALERJQ-30-W	326	7871	ROPE-NT 150 SINGLE	218
461	ALERJQ-30-B	326	7871	ROPE-NT 150 SINGLE	219
463	ZONAJQ-37-B	327	7980	APO TM -3	340
464	ZONAJQ-37-W	327	8050	SANGA DL-100	246
810	GAVI CT-2116B-W	205	8091	TUNA MINI N	247
811	GAVI CT-2116B-C	205	8092	MILO 7040T/P-B	245
815	GAVI CT-2116B-C/M	205	8103	HAXA-DSO POWER LED-B	204
1001	STER TS-MF1	334	8121	OYO 5LED-CW	188
1016	CYBER TM -6	334	8220	HLDR-G9	342
1257	T-1\10-B	351	8390	SLICK JQ-L-W	325
1271	T-1\20-B	351	8391	SLICK JQ-L-B	325
1272	IT-1\20-Y	351	8490	J-80W 78MM STAR	100
1273	IT-1\20-RE	351	8491	J-120W 78MM STAR	100
1274	T-1\20-GN	351	8500	J-120W 118MM STAR	100
1275	T-1\20-BL	351	8810	PIRES DL-600	241
1276	T-1\20-W	351	8811	PIRES DL-600 NS	241
1277	IT-1\20-Y\GN	351	8820	ROLF JQ-L	329
1283	T-1\20-MIX	351	8821	ROLF JQ-O	330
1425	SET60-K	336	8822	ROLF MINI JQ-L	329
1426	SET105-K	336	8910	MARID JQ-L	328
1440	ADI 350 1x3W	335	8980	JURBA DL-2180	240
2160	HLDR-E27	341	8981	JURBA DL-218L	240
2161	HLDR-E27-F	342	10418	J-1000W 189MM	99
2162	HLDR-E27-D	342	12715	TS-8W 4000K/65	100
2170	HLDR-E14	341	12716	TS-13W 4000K/65	100
2173	HLDR-E14-F	341	12717	TS-14W 4000K/82	100
2180	ZARK KRT \2-1	340	14936	TANO G4 SMD-WW	71
2181	ZARK KRW -3	340	14937	TANO G4 SMD-NW	71
2186	PIN W\US	339	14977	LINUS LINK	204
2550	NAVI CTX-DT10-W	179	15098	RANGO R7S SMD-WW	77
2553	NAVI CTX-DT10-C/M	179	15099	RANGO MINI R7S SMD-WW	77
2580	LUTO CTX-DS02B-W	179	18120	FOGLER DL-2400	242
2583	LUTO CTX-DS02B-C/M	179	18121	FOGLER LED 14W-NW	242
2584	LUTO CTX-DS02B-AB	179	18192	GORDO N 1W CW-L-SR	281
2590	LUTO CTX-DT02B-W	179	18193	GORDO N 1W CW-O-SR	281
2591	LUTO CTX-DT02B-C	179	18194	MORO N IG-20	283
2780	VIDI CTC-5515-W	180	18280	SEIDY CT-DT050-AL	166
2781	VIDI CTC-5515-C	180	18281	SEIDY CT-DTL50-AL	166
2783	VIDI CTC-5515-C/M	180	18288	SEIDY CT-DT050-B	166
2790	VIDI CTC-5514-W	180	18289	SEIDY CT-DTL50-B	166
2791	VIDI CTC-5514-C	180	18420	G9-20W STAR	99
2793	VIDI CTC-5514-C/M	180	18421	G9-33W STAR	99
2824	HORN CTC-3114-GM/N	181	18422	G9-48W STAR	99
4260	TUNA S1101-W	247	18423	G9-60W STAR	99
4381	ZEPO LFD-T02-C/M	202	18502	LED12 G4-WW	71
4386	ZEPO LFD-T02/S-C/M	202	18503	LED12 G4-NW	71
4703	MARIN CT-S80-C	187	18510	MORTA CT-DSL50-B	173
4704	MARIN CT-S80-SN	187	18512	MORTA CT-DSL50-SR	173
4710	MARIN CT-S80-AB	187	18521	MAH PLUS-236-ABS/PC	225
4862	GRIP GP\S	339	18530	GWEN CT-DTL50-B	178
4863	GRIP W\US	339	18531	GWEN CT-DT050-B	178
4864	STAN GP	339	18560	EVIT CT-DTL50-AL	178
7015	MARC DL-60	243	18561	EVIT CT-DT050-AL	178
7025	TURK DL-60	247	18593	CL-MAH PLUS	225
7080	BART EL-235	277	18594	CL-MAH PLUS-INOX	225
7150	SUZI HR-60-SR	153	18983	TURRO LED 3X15W-NW	280
7151	SUZI HR-60-B	153	19000	PIRES ECO DL-250	241
7152	SUZI HR-60-BL	153	19001	PIRES ECO DL-250 NS	241
7153	SUZI HR-60-PK	153	19030	CONNECTOR 8	79
7154	SUZI HR-60-W	153	19032	CONNECTOR 8-CP	79
7172	BERG DL-100	282	19033	CONNECTOR 8-CPC	79
7173	BERG DL-10L	282	19036	CONNECTOR RGB 10-CP	85
7195	XARD DL-40	283	19037	CONNECTOR RGB 10-CPC	85
7280	ROGER DL-LED12	281	19038	CONNECTOR RGB 10	85
7281	ROGER DL-2LED6	281	19062	DABA N LED SMD DL-16W	238
7360	RADAN CT-DT050	181	19065	DABA PRO 25W NW-B	238
7362	RADAN CT-DS050	181	19066	DABA PRO 26W NW-SE-W	238
7371	TESON AL-DTL50	181	19161	PROFILO B	88
7372	TESON AL-DS050	181	19162	PROFILO C	89
7373	TESON AL-DSL50	181	19163	PROFILO D	90
7560	ZARA HR-40-SR	153	19181	STOPPER B	88
7561	ZARA HR-40-B	153	19182	STOPPER C	89
7564	ZARA HR-40-W	153	19183	STOPPER D	90
7690	MERGEJQ-L	328	19300	PIXA KT-40-W	152

19301	PIXA KT-40-B	152	22946	RAPID PRO v2 E27-NW	49
19440	MORTA CT-DSO50-B	173	22947	RAPID PRO v2 E27-WW	49
19442	MORTA CT-DSO50-SR	173	22948	RAPID MAXX v2 E27-NW	49
19454	SEIDY CT-DTL50-W/M	166	22949	RAPID MAXX v2 E27-WW	49
19455	SEIDY CT-DTL250-W/M	166	22954	RAPID HI v2 E27-NW	49
19456	SEIDY CT-DTO50-W/M	166	22955	RAPID HI v2 E27-WW	49
19457	SEIDY CT-DTO50-B/M	166	23100	SOLA LED WW	199
19458	SEIDY CT-DTL50-B/M	166	23102	TERRA LED WW	197
19459	SEIDY CT-DTL250-B/M	166	23104	TERRA LED CW	197
19730	REGIS 3 EVG 418 PT	216	23106	APUS LED WW	196
19731	NOTUS 3 EVG 418 NT	218	23107	APUS LED CW	196
19732	NOTUS 3 EVG 236 NT	218	23108	SABIK LED WW	198
19733	NOTUS 3 EVG 218 NT	218	23109	SABIK MINI LED WW	198
19734	REGIS 3 OPAL 418 PT	216	23110	SABIK LED CW	198
19736	REGIS 4LED OPAL 418PT	217	23111	SABIK MINI LED CW	198
19761	GAVI LED18 SMD-WW-C/M	205	23120	JASMIN 270-WE	122
19921	T8 18W/840 NW	101	23121	JASMIN 370-WE	122
19922	T8 18W/865 CW	101	23122	JASMIN 470-WE	122
19924	T8 36W/840 NW	101	23123	JASMIN 270-W	122
19925	T8 36W/865 CW	101	23124	JASMIN 370-W	122
22110	MORTA B CT-DSL50-B	174	23125	JASMIN 470-W	122
22112	MORTA B CT-DSL50-SR	174	23126	JASMIN 270-W/M	122
22116	MORTA B CT-DSO50-B	174	23127	JASMIN 370-W/M	122
22117	MORTA B CT-DSO50-SR	174	23128	JASMIN 470-W/M	122
22140	CONTROLLER LED RGB-RF	85	23412	TEDI MAXX LED GU 10-WW	69
22144	REMOTE MONO	87	23413	TEDI MAXX LED GU 10-CW	69
22145	REMOTE CCT	87	23414	TEDI MAXX LED GU 10-NW	69
22146	REMOTE RGBW	87	23418	BILO 4,9W E27-NW	64
22147	CTR L 12/24V MONO/CTT	87	23419	BILO 4,9W E27-WW	64
22148	CTR L 12/24V RG BW CTT	87	23428	BILO 4,9W E14-NW	64
22340	FRANCO 15LED SMD KT-W	155	23429	BILO 4,9W E14-WW	64
22341	FRANCO 15LED SMD KT-B	155	23434	DUN 4,9W E14-WW	59
22371	AZ-10A	333	23435	DUN 4,9W E14-NW	59
22422	ESG LED 9W GX53-WW	77	23436	DUN 6,5W E14-NW	59
22423	ESG LED 9W GX53-NW	77	23437	DUN 6,5W E14-WW	59
22424	ESG LED 9W GX53-CW	77	23438	IDO 6,5W E14-NW	59
22430	DALLA CT-DTO50-W	171	23439	IDO 6,5W E14-WW	59
22431	DALLA CT-DTL50-W	171	23450	ALER MINI-W	326
22432	DALLA CT-DTO50-B	171	23451	MERGE ADJ-O	331
22433	DALLA CT-DTL50-B	171	23452	ZONA FLAT-W	327
22440	ZEW EL-235J-B	276	23453	MERGE MW-L	331
22441	ZEW EL-235U-B	276	23520	IMBER LED NW	188
22442	ZEW EL-235J-GR	276	23521	IMBER LED CW	188
22443	ZEW EL-235U-GR	276	23522	IMBER LED WW	188
22551	BORD DLP-50-W	111	23756	JASMIN WE-W	121
22552	BORD DLP-50-B	111	23757	JASMIN W-W	121
22603	MAH-LED N 20W-NW/PC	223	23758	JASMIN W/M-W	121
22604	MAH-LED N 40W-NW/PC	223	23800	APUS LED AC-WW	196
22605	MAH-LED N 50W-NW/PC	223	23801	APUS LED AC-CW	196
22606	MAH LED HI 19W-NW RYF	222	23802	SABIK LED AC-WW	198
22607	MAH LED HI 38W-NW RYF	222	23804	SOLA LED AC-WW	199
22608	MAH LED HI 48W-NW RYF	222	23806	TERRA LED AC-WW	197
22609	MAH LED HI 26W-NW RYF	222	23843	TRIBIS II LAB	184
22671	NOTUS 4LED 418 NT	219	23844	TRIBIS II L C	184
22672	NOTUS 4LED 236 NT	219	23845	TRIBIS II L C/M	184
22673	REGIS 4LED 418 PT	217	23846	TRIBIS II O AB	184
22674	NOTUS 4LED 218 NT	219	23847	TRIBIS II O C	184
22704	TOMI LED5W MR16-WW	76	23848	TRIBIS II O C/M	184
22705	TOMI LED5W MR16-CW	76	23849	TRIBIS II L W	184
22706	TOMI LED7W MR16-WW	76	23853	TRIBIS II L B	184
22707	TOMI LED7W MR16-CW	76	23854	TRIBIS II O W	184
22733	SIGO R39 LED E14-WW	76	23855	TRIBIS II O B	184
22734	SIGO R39 LED E14-NW	76	23860	DRIVE LED 0-15W 12VDC	336
22735	SIGO R50 LED E14-WW	76	24240	CIRCO LED 12VDC 0-10W	336
22736	SIGO R50 LED E14-NW	76	24241	CIRCO LED 12VDC 0-15W	336
22737	SIGO R63 LED E27-WW	76	24362	SONOR GU10 CO-B WW	107
22738	SIGO R63 LED E27-NW	76	24410	SOREN O-SR WW /LED	171
22800	MAH PLUS-236/4LED/PC	224	24411	SOREN O-BL /LED	171
22801	MAH PLUS-258/4LED/PC	224	24413	SOREN L-SR WW /LED	171
22802	MAH PLUS-136/4LED/PC	224	24414	SOREN L-BL /LED	171
22803	MAH PLUS-158/4LED/PC	224	24416	SOREN O-SR CW /LED	171
22841	HIMA LED 23W-NW-W	248	24417	SOREN L-SR CW /LED	171
22842	HIMA LED 23W-NW-B	248	24513	LEDS-B 4 8W/M IP65-WW	79
22843	HIMA LED 33W-NW-W	248	24514	LEDS-B 4 8W/M IP65-NW	79
22844	HIMA LED 33W-NW-B	248	24515	LEDS-B 4 8W/M IP65-CW	79
22944	RAPID v2 E27-NW	49	24516	LEDS-B 4 8W/M IP00-WW	79
22945	RAPID v2 E27-WW	49	24517	LEDS-B 4 8W/M IP00-NW	79

INDEX PAR CODE
INDICE PER CODICE PRODOTTO

24518	LEDS-B 4 8W/M IP00-CW	79	26540	PROFILO B 2m	88
24519	ZUBI LED 4W G9-CW	70	26541	PROFILO C 2m	89
24526	ZUBI LED 4W G9-WW	70	26542	PROFILO D 2m	90
24527	ZUBI LED 4W G9-NW	70	26544	PROFILO J	94
24528	ZUBI LED 4W E14-WW	70	26545	PROFILO J 2M	94
24529	ZUBI LED 4W E14-NW	70	26546	PROFILO J-W	94
24530	LEDS-B 7 2W/M IP00RGB	85	26547	PROFILO J-W 2M	94
24531	LEDS-B 7 2W/M IP65RGB	85	26548	PROFILO K	95
24532	LEDS-B 7 2W/M IP54RGB	85	26549	PROFILO K 2m	95
24640	TYBIA LED 38W-NW	239	26550	PROFILO K-W	95
24641	TYBIA LED 38W-NW-SE	239	26551	PROFILO K-W 2m	95
24642	TYBIA LED 38W-NW B	239	26552	PROFILO F	91
24643	TYBIA LED 38W-NW-SE B	239	26553	PROFILO F 2m	91
24644	TYBIA M 25W-NW GY	239	26558	PROFILO G	92
24645	TYBIA M 25W-NW B	239	26559	PROFILO G 2m	92
24646	TYBIA M 25W-NW-SE GY	239	26560	PROFILO H	93
24647	TYBIA M 25W-NW-SE B	239	26561	PROFILO H 2m	93
24651	STONO 30	296	26562	CONNECT-L C	89
24654	STONO 20 N	296	26563	CONNECT C/D/E/I	89
25476	GORD XS DLP 50-B	112	26563	CONNECT C/D/E/I	90
25477	GORD XS DLP 50-W	112	26564	SHADE J/K-FR	94
25478	BORD XS DLP-50-B	112	26564	SHADE J/K-FR	95
25479	BORD XS DLP-50-W	112	26565	SHADE J/K-W	94
25591	PSR 100	213	26565	SHADE J/K-W	95
25690	PLAFMIN O	244	26566	SHADE J/K-FR 2m	94
25710	REGIS 3WS EVG 418 PT	216	26566	SHADE J/K-FR 2m	95
25711	NOTUS 3WS EVG 418 NT	218	26567	SHADE J/K-W 2m	94
25712	NOTUS 3WS EVG 236 NT	218	26567	SHADE J/K-W 2m	95
25713	REGIS 3WS OPAL 418 PT	216	26568	SHADE B/F-FR	88
25720	AKVEN LED	300	26568	SHADE B/F-FR	91
25780	IVIAN LED 4,5W W-WW	253	26569	SHADE B/F-W	88
25781	IVIAN LED 4,5W SN-WW	253	26569	SHADE B/F-W	91
25782	IVIAN LED 4,5W W-NW	253	26570	SHADE B/F-FR 2M	88
25783	IVIAN LED 4,5W SN-NW	253	26570	SHADE B/F-FR 2M	91
25990	NAVI CTX-DS10-B	179	26571	SHADE B/F-W 2M	88
25991	NAVI CTX-DT10-B	179	26571	SHADE B/F-W 2M	91
25995	VIDI CTC-5514-B	180	26572	SHADE C/D/E/I-FR	89
25996	VIDI CTC-5515-B	180	26572	SHADE C/D/E/I-FR	90
26039	ST 45 LED 0,5W E27-BL	50	26573	SHADE C/D/E/I-FR 2M	89
26045	ST 45 LED 0,5W E27-WW	50	26573	SHADE C/D/E/I-FR 2M	90
26046	ST 45 LED 0,5W E27-NW	50	26574	SHADE C/D/E/I-W	89
26047	ST64 A 4W-SW	51	26574	SHADE C/D/E/I-W	90
26048	ST 45 LED 0,5W E27-GR	50	26575	SHADE C/D/E/I-W 2M	89
26049	ST 45 LED 0,5W E27-RE	50	26575	SHADE C/D/E/I-W 2M	90
26058	T8 LED GLASSv3 22W-NW	74	26576	SHADE CK C/D/E/I-FR	89
26059	T8 LED GLASSv3 22W-CW	74	26576	SHADE CK C/D/E/I-FR	90
26062	T8 LED GLASSv3 9W-NW	74	26577	SHADE CK C/D/E/I-FR2M	89
26063	T8 LED GLASSv3 9W-CW	74	26577	SHADE CK C/D/E/I-FR2M	90
26064	T8 LED GLASSv3 18W-NW	74	26578	SHADE CK C/D/E/I-W	89
26065	T8 LED GLASSv3 18W-CW	74	26578	SHADE CK C/D/E/I-W	90
26068	T8LED GLASSv3T 18W NW	74	26579	SHADE CK C/D/E/I-W 2M	89
26069	T8 LED STARTER	74	26579	SHADE CK C/D/E/I-W 2M	90
26303	QULES AC O-W	187	26580	SHADE CK G	92
26304	QULES AC O-C/M	187	26581	SHADE CK G 2M	92
26306	QULES AC O-B	187	26582	SHADE-U H-FR	93
26326	COB SET 3m DIM-WW	86	26583	SHADE-U H-FR 2m	93
26327	COB SET 3m DIM-NW	86	26584	SHADE-U H-W	93
26360	ALDO 4LED 1X60	228	26585	SHADE-U H-W 2m	93
26361	ALDO 4LED 1X120	228	26586	SHADE-O H-W	93
26362	ALDO 4LED 1X150	228	26587	SHADE-O H-W 2m	93
26364	ALDO 4LED 2X120	228	26588	STOPPER J	94
26365	ALDO 4LED 2X150	228	26589	STOPPER K	95
26440	VARSO LED 18W-WW-O	234	26590	STOPPER F	91
26441	VARSO LED 18W-NW-O	234	26592	STOPPER G	92
26443	VARSO LED 18W-NW-L	234	26593	STOPPER-U H	93
26444	VARSO LED 24W-WW-O	234	26594	STOPPER-O H	93
26445	VARSO LED 24W-NW-O	234	26595	HANDLE J/K	94
26447	VARSO LED 24W-NW-L	234	26595	HANDLE J/K	95
26448	VARSO HI 36W-NW-O	234	26596	HANDLE B/F	88
26449	VARSO HI 36W-NW-L	234	26596	HANDLE B/F	91
26461	TAXI SMD L C/M-NW	279	26597	HANDLE C/D/E/I	89
26463	TAXI SMD P C/M-NW	279	26597	HANDLE C/D/E/I	90
26520	SANSO LED 15W-NW-SE	243	26598	HANDLE G	92
26536	APUS LED AC B-NW	196	26599	HANDLE H	93
26537	APUS LED AC B-WW	196	26600	HANDLE SIDE H	93
26538	APUS LED B-NW	196	26602	SEALINGS G	92
26539	APUS LED B-WW	196	26604	CONNECT-L B	88

INDEX PAR CODE
INDICE PER CODICE PRODOTTO

26605	STOPPER J-W	94	27115	TP SLIM LED 40W-NW	221
26606	STOPPER K-W	95	27116	TP SLIM LED 50W-NW	221
26680	ASTEN LED IP44 8W-NW	190	27117	TP SLIM TW LED 40W-NW	221
26681	ASTEN LED IP44 12W-NW	190	27118	TP SLIM TW LED 50W-NW	221
26682	ASTEN LED IP44 15W-NW	190	27155	HB PRO LED HI 100W-NW	272
26683	ASTEN IP44 8W-NW-B	190	27156	HB PRO LED HI 150W-NW	272
26684	ASTEN IP44 12W-NW-B	190	27157	HB PRO LED HI 200W-NW	272
26685	ASTEN IP44 15W-NW-B	190	27212	KANTI V2LED 12W-NW-SN	261
26686	ASTEN IP44 8W-NW-W	190	27213	KANTI V2LED 18W-NW-SN	261
26687	ASTEN IP44 12W-NW-W	190	27216	KATRO V2LED 24W-NW-SN	258
26688	ASTEN IP44 15W-NW-W	190	27220	ROUNDA V2LED24W-NW-SN	256
26700	ROLSO LED IP44 15W-NW	189	27221	ROUNDA V2LED6W-NW-SN	256
26714	MORTA OCT-SR	174	27318	IQ-LED ES-111 12W-WW	72
26715	MORTA OCT-B	174	27319	IQ-LED ES-111 12W-NW	72
26716	MORTA CT-DT050-SR	173	27322	SPAG S B/G AWY	162
26717	MORTA CT-DT050-B	173	27324	SPAG C B/G AWY	162
26718	MORTA CT-DTL50-SR	173	27326	SPAG D B/G AWY	162
26719	MORTA CT-DTL50-B	173	27327	SPAG D W/G AWY	162
26720	ARET 1XMR16-W	175	27370	APUS LED PIR WW	196
26723	ARET 2XMR16-W	175	27378	APUS LED W-NW	196
26726	ALOR DSL-W	169	27379	APUS LED PIR NW	196
26727	ALOR DSL-B	169	27482	PICTO ONTEC G D5	349
26731	ALOR DTL-W	169	27483	PICTO ONTEC G D2	349
26732	ALOR DTL-B	169	27484	PICTO ONTEC G D3	349
26736	IVRI DTO-W	175	27485	PICTO ONTEC G D8	349
26738	APRILA DTO-W	165	27488	PICTO ONTEC G D7	349
26740	COLIE DTO-W	177	27490	PICTO ONTEC G W1	349
26741	COLIE DTO-G	177	27497	PICTO ONTEC G F1	349
26743	COLIE DTO-B	177	27498	PICTO ONTEC G F2	349
26744	COLIE DTO-GR	177	27499	PICTO ONTEC G DB	349
26747	NESTA DSL-C	177	27500	PICTO ONTEC G DC	349
26748	NESTA DSL-C/M	177	27505	PICTO ONTEC S D5	350
26751	NESTA DTL-C	177	27506	PICTO ONTEC S D2	350
26752	NESTA DTL-C/M	177	27507	PICTO ONTEC S D3	350
26753	ALREN DTL-W	176	27508	PICTO ONTEC S D8	350
26754	ALREN DTL-B	176	27509	PICTO ONTEC S D1	350
26756	ALREN DTL-C/M	176	27510	PICTO ONTEC S D6	350
26757	ALREN R DTL-B	176	27511	PICTO ONTEC S D7	350
26758	ALREN R DTL-W	176	27512	PICTO ONTEC S D4	350
26766	BILO 6,5W E14-NW	64	27513	PICTO ONTEC S W1	350
26767	BILO 6,5W E14-WW	64	27514	PICTO ONTEC S W2	350
26768	BILO 6,5W E27-NW	64	27520	PICTO ONTEC S F1	350
26769	BILO 6,5W E27-WW	64	27522	PICTO ONTEC S DB	350
26770	AVAR 6060 40W-NW	214	27523	PICTO ONTEC S DC	350
26771	AVAR 6060 40W-CW	214	27527	ONTEC S M1180MSTW	344
26773	AVAR 6262 40W-NW	214	27528	ONTEC S 20M1X ST W	344
26774	AVAR 6262 40W-WW	214	27529	ONTEC S 20M1X AT W	344
26790	ALOR DSO-W	169	27558	SOLA LED B-NW	199
26791	ALOR DSO-B	169	27559	SOLA LED B-WW	199
26795	ALOR DTO-W	169	27567	RITI GU10 B/B	111
26796	ALOR DTO-B	169	27569	RITI GU10 W/W	111
26810	POWELED P 12V 30W	335	27570	RITI GU10 W/G	111
26811	POWELED P 12V 60W	335	27571	RITI GU10 B/G	111
26815	POWELED P 24V 30W	335	27575	MINI RITI GU10 B/G	163
26816	POWELED P 24V 60W	335	27576	MINI RITI GU10 W/G	163
26820	SENTO	332	27577	MINI RITI GU10 B/W	163
26821	SENZO	332	27578	MINI RITI GU10 B/B	163
26830	STOBI DLP 50-B	110	27579	MINI RITI GU10 W/W	163
26831	STOBI DLP 50-W	110	27590	LINUS LED 4W-NW	204
26832	STOBI DLP 250-B	110	27591	LINUS LED 7W-NW	204
26833	STOBI DLP 250-W	110	27602	HERON II LED B	152
26840	APUS LED W-WW	196	27603	HERON II LED W	152
26841	APUS LED W-CW	196	27610	ADTR 6060 SR	209
26842	TERRA LED W-WW	197	27610	ADTR 6060 SR	213
26843	TERRA LED W-CW	197	27611	ADTR 12030 W	209
26848	TERRA LED B-NW	197	27611	ADTR 12030 W	213
26849	TERRA LED B-WW	197	27612	ADTR 12030 SR	209
26961	MEBA 4LED 2X120 PS	227	27612	ADTR 12030 SR	213
26964	MEBA 4LED 2X120 OP PS	227	27613	ADTR 6060 W	209
26965	MEBA 4LED 2X150 OP PS	227	27613	ADTR 6060 W	213
26980	VARSO LED 18W-NW-L-SE	234	27614	ADTR 12030 B	209
26981	VARSO LED 18W-NW-O-SE	234	27614	ADTR 12030 B	213
26983	VARSO LED 24W-NW-L-SE	234	27615	ADTR 6060 B	209
26984	VARSO LED 24W-NW-O-SE	234	27615	ADTR 6060 B	213
26985	VARSO HI 36W-NW-O-SE	234	27616	ADTR-S 6060 W	209
27000	ETISSA D20 GR	106	27617	ADTR-S-H 6060 W	209
27001	OGIVA D35 GR	106	27652	ONTECS C1302MATW	344

INDEX PAR CODE
INDICE PER CODICE PRODOTTO

27769	ITECH M1 60 NM ST W	346	29001	GORI EL 235 D	292
27800	ELNIS S W	170	29002	GORI 50	292
27804	ELNIS L W	170	29003	GORI 80	292
27805	ELNIS L W/A	170	29010	VADRA 16L-UP	293
27806	ELNIS L W/C	170	29011	VADRA 21L-UP SE	293
27808	ELNIS L A/C	170	29012	VADRA 50	293
27809	ELNIS LA	170	29013	VADRA 80	293
27810	ELNIS L B/G	170	29031	IMINES DSO-W	165
28002	BRAVO PU36W6060NW W	212	29098	ONTEC R M1 60N M STW	348
28010	BRAVO S 40W6060NW W	212	29110	MILENO EL-10 B-AG	138
28022	BRAVO S 40W12030NW W	212	29111	MILENO EL-10 ASR-AN	138
28025	BRAVO DRIVER 36W	212	29112	MILENO EL-30 B-AG	138
28026	BRAVO DRIVER 40W	212	29113	MILENO EL-30 ASR-AN	138
28029	BRAVO DRIVER 28W	212	29114	MILENO EL-21 B-AG	138
28500	BRAVO S/P GRIP 60-62	213	29115	MILENO EL-21 ASR-AN	138
28501	BRAVO S/P GRIP 12030	213	29116	MILENO EL-31 B-AG	138
28502	CLIPS BRAVO S/P 60-62	213	29117	MILENO EL-31 ASR-AN	138
28503	CLIPS BRAVO S/P 12030	213	29118	MILENO EL-41 B-AG	138
28504	SPN BRAVO S/P 60-62	213	29119	MILENO EL-41 ASR-AN	138
28505	SPN BRAVO S/P 12030	213	29120	LAURIN EL-10 W	132
28508	BRAVO DALI SET 36W	212	29121	LAURIN EL-10 B	132
28512	AVAR DALI SET 40W	214	29122	LAURIN EL-21 W	132
28515	BLINGO DALI SET 38W	211	29123	LAURIN EL-21 B	132
28515	BLINGO DALI SET 38W	211	29124	LAURIN EL-31 W	132
28551	BRAVO PU28W3060NW W	212	29125	LAURIN EL-31 B	132
28760	ENALI EL-10 W	136	29126	LAURIN EL-30 W	132
28761	ENALI EL-10 B	136	29127	LAURIN EL-30 B	132
28762	ENALI EL-21 W	136	29128	LAURIN EL-40 W	132
28763	ENALI EL-21 B	136	29129	LAURIN EL-40 B	132
28764	ENALI EL-30 W	136	29131	SIMEN DSL B/W/B	168
28765	ENALI EL-30 B	136	29132	SIMEN DSL SR/B/B	168
28766	ENALI EL-31 W	136	29134	SIMEN DSL B/G/B	168
28767	ENALI EL-31 B	136	29135	SIMEN DSL W/G/W	168
28768	ENALI EL-41 W	136	29137	SIMEN DSO B/G	168
28769	ENALI EL-41 B	136	29138	SIMEN DSO B/W	168
28780	MINI GORD DLP-50-W	163	29139	SIMEN DSO W/B	168
28781	MINI GORD DLP-50-B	163	29140	SIMEN DSO W/G	168
28782	MINI BORD DLP-50-W	164	29142	SIMEN DSO G/W	168
28783	MINI BORD DLP-50-B	164	29160	ORTE LED 18W-NW-O	237
28930	ROUND V2LED12W-NW-SR	256	29161	ORTE LED 24W-NW-O	237
28931	ROUND V2LED12W-NW-W	256	29162	ORTE LED 18W-NW-O-SE	237
28932	ROUND V2LED12W-WW-W	256	29163	ORTE LED 24W-NW-O-SE	237
28933	ROUND V2LED18W-NW-SR	256	29170	INVO OP EL-53-L-GR	294
28934	ROUND V2LED18W-NW-W	256	29171	INVO OP 47-L-GR	294
28935	ROUND V2LED18W-WW-W	256	29172	INVO OP 77-L-GR	294
28936	ROUND V2LED24W-NW-W	256	29173	INVO OP 107-L-GR	294
28937	ROUND V2LED6W-NW-W	256	29174	INVO TR EL-53-O-GR	295
28938	ROUND V2LED6W-WW-W	256	29175	INVO TR 47-O-GR	295
28939	KATRO V2LED 12W-NW-SR	258	29176	INVO TR 77-O-GR	295
28940	KATRO V2LED 12W-NW-W	258	29177	INVO TR 107-O-GR	295
28941	KATRO V2LED 12W-WW-W	258	29205	JASMIN 470-B	122
28942	KATRO V2LED 18W-NW-SR	258	29207	JASMIN 270-B	122
28943	KATRO V2LED 18W-NW-W	258	29208	JASMIN 370-B	122
28945	KATRO V2LED 24W-NW-W	258	29209	JASMIN B-W	121
28946	KATRO V2LED 6W-NW-W	258	29210	MERA LED 5W NW	203
28948	CARSA V2LED 12W-NW-W	260	29211	MERA LED 10W NW	203
28949	CARSA V2LED 18W-NW-W	260	29212	MERA LED 15W NW	203
28950	KANTI V2LED 12W-NW-W	261	29213	MERA LED 20W NW	203
28951	KANTI V2LED 18W-NW-W	261	29214	MERA LED PP	203
28961	POWELED P 12V 100W	335	29222	STATO N LED 30W-B	267
28962	POWELED P 24V 100W	335	29223	STATO N LED 50W-B	267
28963	POWELED P 12V 150W	335	29231	GOVIK DSO-W/G	160
28964	POWELED P 24V 150W	335	29232	GOVIK DSO-B/G	160
28965	POWELED P 12V 200W	335	29233	GOVIK-ST DSO-W/G	160
28966	POWELED P 24V 200W	335	29234	GOVIK-ST DSO-B/G	160
28973	ONTEC S M1180MATW	344	29235	GOVIK DSO-W A	160
28974	ZEST MON OS010 W	345	29236	GOVIK DSO-B A	160
28976	ONTEC G E1E 301 M STW	347	29237	GOVIK-ST DSO-B	160
28977	ONTEC S C1302MATWCLD	344	29238	GOVIK-ST DSO-W	160
28978	ONTEC S C160NMATW	344	29240	SANI IP44 DSO-B	107
28979	ONTEC G E1E180MATW	347	29241	SANI IP44 DSO-W	107
28985	ZEST POD OR00 B	345	29242	SANI IP44 DSO-SN	107
28990	REKA LED EL 7W-L-GR	274	29260	BISO LED EL 8W-GR	275
28991	REKA LED EL 7W-O-GR	274	29261	BISO LED EL 8W-W	275
28992	REKA LED EL 7W-L-W	274	29270	GARTO LED EL 8W-GR	275
28993	REKA LED EL 7W-O-W	274	29271	GARTO LED EL 8W-W	275
29000	GORI EL 135 D	292	29300	MODv2 LED 12W-WW	78

INDEX PAR CODE
INDICE PER CODICE PRODOTTO

29301	MODv2 LED 12W-NW	78	32495	MEFIS LED W-NW	200
29302	MODv2 LED 19W-WW	78	32497	MEFIS LED B-NW	200
29303	MODv2 LED 19W-NW	78	32500	MARIN CT-S80-W	187
29310	CHIRO GU10 DTO-W	162	32501	MARIN CT-S80-B	187
29311	CHIRO GU10 DTO-B	162	32520	TONIL LED B	143
29313	CHIRO GU10 DTL-B	162	32521	TONIL LED W	143
29580	AREL LED DO 6W-NW	252	32930	MATEO ES DLP-150-B	253
29581	AREL LED DO 6W-WW	252	32931	MATEO ES DLP-150-W	253
29582	AREL LED DL 6W-NW	252	32932	MATEO ES DLP-250-B	253
29584	AREL LED DO 10W-NW	252	32933	MATEO ES DLP-250-W	253
29585	AREL LED DO 10W-WW	252	32940	BENO 18W NW-O-W	233
29586	AREL LED DL 10W-NW	252	32942	BENO 18W NW-L-W	233
29588	AREL LED DO 14W-NW	252	32944	BENO 18W NW-O-SE W	233
29589	AREL LED DO 14W-WW	252	32946	BENO 18W NW-L-SE W	233
29590	AREL LED DL 14W-NW	252	32948	BENO N 18W NW-O-SE GR	233
29600	XLED A60 4,5W-WW	44	32949	BENO N 18W NW-L-SE GR	233
29601	XLED A60 7W-WW	44	32952	BLURRO 2xGU10 CO-B	113
29602	XLED A60 7W-NW	44	32953	BLURRO 2xGU10 CO-W	113
29603	XLED A60 7W-CW	44	33070	REXAR LED W	155
29604	XLED A60 8W-WW	44	33071	REXAR LED B	155
29605	XLED A60 10W-WW	44	33080	REMI LED GU 10-NW	69
29606	XLED A60 10W-NW	44	33081	REMI LED GU 10-WW	69
29607	XLED A60 4,5W-WW-M	46	33082	REMI LED GU 10-CW	69
29608	XLED A60 4,5W-NW-M	46	33090	SEMPRA EL-11 W-SR	134
29609	XLED A60 7W-WW-M	46	33091	SEMPRA EL-11 B-SR	134
29610	XLED A60 7W-NW-M	46	33092	SEMPRA EL-21 W-SR	134
29612	XLED A60 8W-WW-M	46	33093	SEMPRA EL-21 B-SR	134
29613	XLED A60 8W-NW-M	46	33094	SEMPRA EL-31 W-SR	134
29615	XLED A60 10W-WW-M	46	33095	SEMPRA EL-31 B-SR	134
29616	XLED A60 10W-NW-M	46	33096	SEMPRA EL-41 W-SR	134
29617	XLED C35E14 2,5W-WW	58	33097	SEMPRA EL-41 B-SR	134
29618	XLED C35E14 4,5W-WW	58	33100	XLED A60 B22 7W-WW	48
29619	XLED C35E14 4,5W-NW	58	33102	XLED A60 B22 7W-WW-M	48
29620	XLED C35E14 4,5W-WW-M	58	33103	XLED A60 B22 7W-CW-M	48
29621	XLED C35E14 4,5W-NW-M	58	33108	XLED A60 B22 10W-WW-M	48
29622	XLED C35E14 6W-WW-M	58	33109	XLED A60 B22 10W-CW-M	48
29623	XLED C35E14 6W-NW-M	58	33120	FLINI IP44 DSL-B	186
29624	XLED G45 E14 4,5W-WW	62	33121	FLINI IP44 DSL-W	186
29625	XLED G45 E27 4,5W-WW	62	33122	FLINI IP44 DSO-B	186
29626	XLED G45E14 4,5W-WW-M	63	33123	FLINI IP44 DSO-W	186
29627	XLED G45E14 4,5W-NW-M	63	33125	DROXY IP65 DSO-W	186
29628	XLED G45 E14 6W-WW-M	63	33126	DROXY IP65 DSO-B	186
29629	XLED G45 E14 6W-NW-M	63	33130	ATL1 18W-930-S6-W	304
29630	XLED G45E27 4,5W-WW-M	63	33131	ATL1 18W-930-S6-B	304
29631	XLED G45E27 4,5W-NW-M	63	33132	ATL1 18W-940-S6-W	304
29632	XLED G45 E27 6W-WW-M	63	33133	ATL1 18W-940-S6-B	304
29633	XLED G45 E27 6W-NW-M	63	33134	ATL1 30W-930-S6-W	304
29634	XLEDA60 7W-WW-STEPDIM	47	33135	ATL1 30W-930-S6-B	304
29635	XLEDA60 7W-NW-STEPDIM	47	33136	ATL1 30W-940-S6-W	304
29637	XLED ST64 7W-WW	51	33137	ATL1 30W-940-S6-B	304
29638	XLED G125 7W-WW	53	33138	ATL2 GU10-W	306
29641	XLED C35T 2,5W-SW	54	33139	ATL2 GU10-B	306
29646	XLED C35E27 6W-WW-M	58	33140	REF ATL1-18W-S15	305
29647	XLED C35E27 6W-NW-M	58	33141	REF ATL1-18W-S36	305
29648	XLED A70 18W-WW	45	33142	REF ATL1-30W-S15	305
29649	XLED A70 18W-NW	45	33143	REF ATL1-30W-S36	305
29832	LART EL-160-GR	277	33144	ATL3 GU10-B	306
29833	LART EL-260-GR	277	33145	ATL3 GU10-W	306
29840	ADTR 3060 W	213	33146	ATL4 GU10-B	307
29841	ADTR 3060 SR	213	33147	ATL4 GU10-W	307
29842	ADTR 3060 B	213	33148	ATL5 GU10-B	307
29843	ADTR-H 6060 W	209	33149	ATL5 GU10-W	307
29843	ADTR-H 6060 W	211	33165	AGEO DSO-B	165
29844	ADTR-H 6060 SR	209	33166	AGEO DSO-W	165
29845	ADTR-H 6060 B	209	33170	TP STRONG LED 48W-NW	220
29852	SABIK LED B-NW	198	33171	TP STRONG LED 75W-NW	220
29853	SABIK LED B-WW	198	33172	TP STRONG LED 90W-NW ()	220
29854	SABIK MINI LED B-NW	198	33177	BLINGO TN38W 6060 NW	208
29855	SABIK MINI LED B-WW	198	33178	BLINGO TN24-28W6060NW	208
29856	APUS LED PIR B-NW	196	33179	BLINGO TUN48W 6060 NW	208
29857	APUS LED PIR B-WW	196	33188	BLINGO PU 36W 6262 NW	208
29858	SABIK LED PIR B-NW	198	33190	HBPH LENS 50D 100W	273
29860	TERRA LED PIR B-NW	197	33191	HBPH LENS 50D 150W	273
29861	TERRA LED PIR B-WW	197	33192	HBPH LENS 50D 200W	273
32488	APUS LED NW	196	33193	HBPH LENS 120D 100W	273
32490	SABIK MINI LED NW	198	33194	HBPH LENS 120D 150W	273
32491	SOLA LED NW	199	33195	HBPH LENS 120D 200W	273

INDEX PAR CODE
INDICE PER CODICE PRODOTTO

33196	HBPH GRID 100W	273	33325	ERINUS LED LL W-NW	194
33197	HBPH GRID 150W	273	33327	ERINUS LED L GR-NW	194
33198	HBPH GRID 200W	273	33329	ERINUS LED O GR-NW	194
33200	ANTEM LED 10W-NW B	266	33330	ERINUS LED LL GR-WW	194
33201	ANTEM LED 20W-NW B	266	33331	ERINUS LED LL GR-NW	194
33202	ANTEM LED 30W-NW B	266	33332	ERINUS LED L B-WW	194
33203	ANTEM LED 50W-NW B	266	33333	ERINUS LED L B-NW	194
33204	ANTEM LED 100W-NW B	266	33334	ERINUS LED O B-WW	194
33205	ANTEM LED 10W-NW-SE B	266	33335	ERINUS LED O B-NW	194
33206	ANTEM LED 20W-NW-SE B	266	33336	ERINUS LED LL B-WW	194
33207	ANTEM LED 30W-NW-SE B	266	33337	ERINUS LED LL B-NW	194
33208	ANTEM LED 50W-NW-SE B	266	33340	BENO 24W NW-O-W	233
33210	T8 LED GLASSv4 9W-NW	75	33341	BENO 24W NW-O-GR	233
33211	T8 LED GLASSv4 9W-CW	75	33342	BENO 24W NW-L-W	233
33212	T8 LED GLASSv4 18W-NW	75	33343	BENO 24W NW-L-GR	233
33213	T8 LED GLASSv4 18W-CW	75	33344	BENO 24W NW-O-SE W	233
33214	T8 LED GLASSv4 24W-NW	75	33345	BENO 24W NW-O-SE GR	233
33215	T8 LED GLASSv4 24W-CW	75	33346	BENO 24W NW-L-SE W	233
33216	T8 LED GLASSv5 12W-NW	75	33347	BENO 24W NW-L-SE GR	233
33217	T8 LED GLASSv5 12W-CW	75	33351	LCO B 10W/M 24 IP00-WW	84
33230	TEAR N TR 1M-W	311	33352	LCO B 10W/M 24 IP65-WW	84
33231	TEAR N TR 1M-B	311	33353	LCO B 10W/M 24 IP00-CW	84
33232	TEAR N TR 2M-W	311	33354	LCO B 10W/M 24 IP65-CW	84
33233	TEAR N TR 2M-B	311	33355	L120B 16W/M 24IP00-WW	81
33234	TEAR N PCON R-W	311	33356	L120B 16W/M 24IP00-NW	81
33235	TEAR N PCON R-B	311	33360	AQILO IP65 DSO-W	108
33236	TEAR N EPLUG W	311	33361	AQILO IP65 DSO-B	108
33237	TEAR N EPLUG B	311	33362	AQILO IP65 DSO-GR	108
33238	TEAR N ICON-I W	311	33364	LCOB 8W/M 12 IP00-WW	83
33239	TEAR N ICON-I B	311	33365	LCOB 8W/M 12 IP65-WW	83
33240	TEAR N CON-I W	310	33366	LCOB 8W/M 12 IP00-NW	83
33241	TEAR N CON-I B	310	33367	LCOB 8W/M 12 IP65-NW	83
33242	TEAR N CON-L RL-W	310	33368	"	84
33243	TEAR N CON-L RL-B	310	33369	LCOB 10W/M 24 IP65-WW	84
33244	TEAR N CON-L LR-W	310	33390	ADTR-H 12030 W	209
33245	TEAR N CON-L LR-B	310	33390	ADTR-H 12030 W	211
33246	TEAR N CON-X W	311	33391	ADTR-H 12030 B	209
33247	TEAR N CON-X B	310	33392	ADTR-H 12030 SR	209
33248	TEAR N CON-T RRL-W	310	33393	ADTR-H 3060 W	211
33249	TEAR N CON-T RRL-B	310	33398	ADTR-H 76MM 6060 W	209
33250	TEAR N CON-T RLL-W	310	33435	ADTR-H 6262 W	209
33251	TEAR N CON-T RLL-B	310	33470	FL AGOR LED 100W NW	262
33252	TEAR N CON-I FLEX W	310	33471	FL AGOR LED 150W NW	262
33253	TEAR N CON-I FLEX B	310	33472	FL AGOR LED 200W NW	262
33254	TEAR N SCLAMP W	311	33473	FL AGOR/A LED 100W	262
33255	TEAR N SCLAMP B	311	33474	FL AGOR/A LED 150W	262
33256	TEAR N SKIT W	311	33475	FL AGOR/A LED 200W	262
33257	TEAR N SKIT B	311	33476	FL AGOR HI 240W NW	263
33260	TEAR N PCON L-W	311	33477	FL AGOR/A HI 240W NW	263
33261	TEAR N PCON L-B	311	33478	FL AGOR HI 300W NW	263
33262	TEAR N CON-T LRR-W	310	33479	FL AGOR/A HI 300W NW	263
33263	TEAR N CON-T LRR-B	310	33482	FL AGOR HI GRID 240W	263
33264	TEAR N CON-T LLR-W	310	33483	FL AGOR HI GRID 300W	263
33265	TEAR N CON-T LLR-B	310	33511	XLED G125 11W-WW	53
33266	TEAR N PADAPTOR-W	313	33512	XLED G125 11W-NW	53
33267	TEAR N PADAPTOR-B	313	33513	XLED ST64C 7W-NW	51
33302	L60 11W/M 12 IP00-WW	80	33514	XLED A60 M 7W-WW	52
33303	L60 11W/M 12 IP00-NW	80	33515	XLED A60 M 7W-NW	52
33304	L60 11W/M 12 IP00-CW	80	33516	XLED A60 4W-SW	54
33305	L60B 11W/M 12 IP00-WW	80	33517	XLED ST64 4W-SW	54
33306	L60B 11W/M 12 IP00-NW	80	33518	XLED G95 4W-SW	54
33307	L60B 11W/M 12 IP00-CW	80	33519	XLED G125 4W-SW	54
33308	L60 11W/M 12 IP65-WW	80	33524	ROUND A V2LED24W-WW-W	256
33309	L60 11W/M 12 IP65-NW	80	33541	CARSA V2LED 24W-NW-W	260
33310	L60 11W/M 12 IP65-CW	80	33562	ROUND A V2LED6W-WW-B	256
33311	L120 16W/M 24 IP00-WW	81	33640	S A60 7W E27 CCT	36
33312	L120 16W/M 24 IP00-NW	81	33641	S A60 9W E27 RGB CCT	36
33314	L120 16W/M 24 IP65-WW	81	33642	S A60 11,5WE27 RGB CCT	36
33315	L120 16W/M 24 IP65-NW	81	33643	S GU10 4,7W RGB CCT	36
33317	L120 16W/M 12 IP00 CCT	82	33644	S C37 4,9W E14 RGB CCT	36
33318	L48 9W/M 24 IP00-RGBW	86	33651	AREL FRAME DO 14W W	252
33319	L48 9W/M 24 IP65-RGBW	86	33670	GALOBA EL-10 W	130
33320	ERINUS LED L W-WW	194	33671	GALOBA EL-10 B	130
33321	ERINUS LED L W-NW	194	33672	GALOBA W 1xGU10 W	143
33322	ERINUS LED O W-WW	194	33673	GALOBA W 1xGU10 B	143
33323	ERINUS LED O W-NW	194	33674	GALOBA EL-21 W	130
33324	ERINUS LED LL W-WW	194	33675	GALOBA EL-21 B	130

33676	GALOBA EL-3I W	130	33881	IQ-LED FL-20W-NW	264
33677	GALOBA EL-3I B	130	33882	IQ-LED FL-30W-NW	264
33678	GALOBA EL-40 W	130	33883	IQ-LED FL-50W-NW	264
33679	GALOBA EL-40 B	130	33884	IQ-LED FL-90W-NW	264
33680	GALOBA EL-4I W	130	33885	IQ-LED FL-10W-NW-SE	264
33681	GALOBA EL-4I B	130	33886	IQ-LED FL-20W-NW-SE	264
33690	GLASI LED 3W P WW-W	279	33887	IQ-LED FL-30W-NW-SE	264
33691	GLASI LED 3W P WW-B	279	33888	IQ-LED FL-50W-NW-SE	264
33692	GLASI LED 3W P WW-GR	279	33889	IQ-LED FL QC I 3x1MM2	264
33693	GLASI LED 3W P NW-W	279	33890	MEBA LED 12-20W NW/WW	227
33694	GLASI LED 3W P NW-B	279	33891	MEBA LED 22-40W NW/WW	227
33695	GLASI LED 3W P NW-GR	279	33892	MEBA LED 20W IP54 NW	226
33701	S AD GN 10A PM	318	33893	MEBA LED 40W IP54 NW	226
33703	S AD GN SCH 10A PM	318	33894	MEBA 4LED 60 IP54 PC	226
33722	IQ-LEDDIM A60 7,3W-WW	42	33895	MEBA 4LED 120 IP54 PC	226
33723	IQ-LEDDIM A60 7,3W-NW	42	33896	MEBA 4LED 150 IP54 PC	226
33724	IQ-LEDDIM A6010,5W-WW	42	34475	NEDIA E14 B	151
33725	IQ-LEDDIM A6010,5W-NW	42	34476	NEDIA E14 W	151
33726	IQ-LEDDIM A6013,6W-WW	42	34920	SONDA II EL-10 B	128
33727	IQ-LEDDIM A6013,6W-NW	42	34921	SONDA II EL-10 W	128
33746	IQ-LED A67 N 19W-WW	41	34922	SONDA II EL-2I B	128
33747	IQ-LED A67 N 19W-NW	41	34923	SONDA II EL-2I W	128
33748	IQ-LED A67 N 19W-CW	41	34924	SONDA II EL-3I B	128
33750	DULI LED 4W-NW-L-GR	278	34925	SONDA II EL-3I W	128
33751	DULI LED 4W-NW-O-GR	278	34926	SONDA II EL-30 B	128
33752	DULI LED 6,5W-NW-L-GR	278	34927	SONDA II EL-30 W	128
33753	DULI LED 6,5W-NW-O-GR	278	34928	SONDA II EL-40 B	128
33760	IQ-LED Life G45 4,2W-WW	38	34929	SONDA II EL-40 W	128
33761	IQ-LED Life G45 4,2W-NW	38	34930	ASTIM IP44 8W-NW-B	189
33762	IQ-LED Life A60 7,2W-WW	38	34931	ASTIM IP44 8W-NW-W	189
33763	IQ-LED Life A60 7,2W-NW	38	34932	ASTIM IP44 8W-NW-C	189
33764	IQ-LED Life GU10 4,8W-WW	38	34933	ASTIM IP44 12W-NW-B	189
33765	IQ-LED Life GU10 4,8W-NW	38	34934	ASTIM IP44 12W-NW-W	189
33769	IQ-LEDEX GU 10 2,5W-NW	65	34935	ASTIM IP44 12W-NW-C	189
33810	ONTEC S W1302MATWCLD	344	34940	S SENSOR PIR INT 10M	316
33812	ITECH M2 302MATW	346	34941	S SENSOR W INT	317
33814	ITECH M5 305MATW	346	34942	S SENSOR ON/OFF INT	316
33815	ITECH C1 302MATW	346	34948	S SWITCH ON/OFF	319
33818	ONTEC S M2302MATWCLD	344	34949	S SWITCH SHUTTER	319
33819	ONTEC S M2102MATWCLD	344	34950	S SWITCH G DOOR	319
33821	ITECH M2 302MSTW	346	34960	TOMiv2 1,2W GU10-CW	68
33822	ITECH M5 105MSTW	346	34961	TOMiv2 1,2W GU10-NW	68
33823	ITECH C1 302 STW	346	34962	TOMiv2 1,2W GU10-WW	68
33824	ITECH F2 105MSTW	346	34963	TOMiv2 2,9W GU10-CW	68
33826	ONTEC R C1 60N M STW	348	34964	TOMiv2 2,9W GU10-NW	68
33829	OPRAWA DWUSTRONNA OSO	345	34965	TOMiv2 2,9W GU10-WW	68
33830	UCHW PODT OS S2 S3 IT	345	34966	TOMiv2 4,9W GU10-CW	68
33832	ITECH M5 105MATW	346	34967	TOMiv2 4,9W GU10-NW	68
33833	ITECH S1 302MATW	346	34968	TOMiv2 4,9W GU10-WW	68
33834	ITECH C2 105MATW	346	34969	TOMiv2 6,5W GU10-CW	68
33835	ITECH F1 302MATW	346	34970	TOMiv2 6,5W GU10-NW	68
33836	ITECH F2 105MATW	346	34971	TOMiv2 6,5W GU10-WW	68
33837	ITECH W2 105MATW	346	34980	VIMO EL 27 B	291
33840	ONTEC S M5105MATW	344	34981	VIMO EL 27 BR	291
33841	ONTEC S M5305MATW	344	34982	VIMO EL 27 SE-B	291
33842	ONTEC S C1302MATW	344	34983	VIMO EL 27 SE-BR	291
33843	ONTEC S C2105MATW	344	34984	VIMO 50 B	291
33844	ONTEC S F2105MATW	344	34985	VIMO 50 BR	291
33845	ONTEC S W1302MATW	344	34986	VIMO 50 SE-B	291
33846	ONTEC S W2105MATWCLD	344	34987	VIMO 50 SE-BR	291
33847	ONTEC C M160NMATW	347	34988	VIMO 80 B	291
33849	ONTEC C C160NMATW	347	34989	VIMO 80 BR	291
33850	ONTEC R M1 60N M ATW	348	35000	STIVI LED 24W-NW-O	236
33851	ONTEC R M2 302 M ATW	348	35001	STIVI LED 24W-NW-O-SE	236
33852	ONTEC R M2 302 M ATW	348	35002	STIVI LED 36W-NW-O	236
33855	ONTEC S M5105MSTW	344	35003	STIVI LED 36W-NW-O-SE	236
33856	ONTEC S M2302MSTWCLD	344	35240	IQ-LED GU10 6,5W-WW	66
33858	ONTEC C M160NMSTW	347	35241	IQ-LED GU10 6,5W-NW	66
33862	ONTEC S C1302MSTW	344	35242	IQ-LED GU10 6,5W-CW	66
33864	ONTEC S F2105MSTW	344	35243	IQ-LED GU10 6,5WS3-WW	66
33865	ONTEC S W1302MSTW	344	35244	IQ-LED GU10 6,5WS3-NW	66
33866	ONTEC S W1302MSTWCLD	344	35245	IQ-LED GU10 6,5WS3-CW	66
33868	ONTEC C C160NMSTW	347	35246	IQ-LEDDIM GU10 7W-WW	67
33871	ZEST MONT OS05	345	35247	IQ-LEDDIM GU10 7W-NW	67
33876	ZEST MONT S20 FLAGA	345	35248	IQ-LEDDIM GU10 7W-CW	67
33877	ZEST MONT OS205	345	35252	IQ-LED AR-111 13W-WW	72
33880	IQ-LED FL-10W-NW	264	35253	IQ-LED AR-111 13W-NW	72

INDEX PAR CODE
INDICE PER CODICE PRODOTTO

35254	IQ-LED EX T8 12W-NW	73	35780	PREDA LED B	154
35255	IQ-LED EX T8 12W-CW	73	35781	PREDA LED W	154
35256	IQ-LED GU 10 4,9W-WW	65	35785	EVALO TL GU10 W-SR	148
35257	IQ-LED GU 10 4,9W-NW	65	35786	EVALO TL GU10 B-SR	148
35258	IQ-LED GU 10 4,9W-CW	65	35787	EVALO FL 3xGU10 W-SR	149
35272	XLED C35 E14 6W-WW	58	35788	EVALO FL 3xGU10 B-SR	149
35273	XLED C35 E14 6W-NW	58	35790	TEAR N RC-PCON W	311
35274	XLED G45 E27 6W-WW	62	35791	TEAR N RC-PCON B	311
35275	XLED G45 E27 6W-NW	62	35792	TEAR N RC-CON-L W	311
35276	XLED G45 E14 6W-WW	62	35793	TEAR N RC-CON-L B	312
35277	XLED G45 E14 6W-NW	62	35794	TEAR N RC-CON-I W	311
35278	XLEDIM C35E14 5,9W-WW	57	35795	TEAR N RC-CON-I B	311
35280	ELICEO DSO B/B	172	35796	TEAR N RC-CON-T W	312
35281	ELICEO DSO W/W	172	35797	TEAR N RC-CON-T B	312
35283	ELICEO DSO W/G	172	35798	TEAR N RC-CON-X W	312
35284	ELICEO-ST DSO B/B	172	35799	TEAR N RC-CON-X B	312
35285	ELICEO-ST DSO W/W	172	35800	TEAR N R-TR 2M-W	311
35287	ELICEO-ST DSO W/G	172	35801	TEAR N R-TR 2M-B	311
35288	ELICEO DSO W	172	35802	TEAR N RCLIP-W	312
35289	ELICEO DSO B	172	35803	TEAR N RCLIP-B	312
35295	ELICEO DSO YG	172	36210	GLOZO DSL W/W	157
35296	ELICEO DSO GR	172	36211	GLOZO DSL B/W	157
35297	ELICEO DSO PK	172	36212	GLOZO DSL G/W	157
35298	ELICEO DSO BL	172	36213	GLOZO DSL SR/W	157
35508	RIFA LED 17,5W NW N2	118	36214	GLOZO DSL W/B	157
35509	RIFA LED 17,5W WW N2	118	36215	GLOZO DSL B/B	157
35640	DERATO EL-10 B-SR	124	36216	GLOZO DSL G/B	157
35641	DERATO EL-10 W-SR	124	36217	GLOZO DSL SR/B	157
35642	DERATO EL-21 B-SR	124	36218	GLOZO DSO W/W	156
35643	DERATO EL-21 W-SR	124	36219	GLOZO DSO B/W	156
35644	DERATO EL-30 B-SR	124	36220	GLOZO DSO G/W	156
35645	DERATO EL-30 W-SR	124	36221	GLOZO DSO SR/W	156
35646	DERATO EL-41 B-SR	124	36222	GLOZO DSO W/B	156
35647	DERATO EL-41 W-SR	124	36223	GLOZO DSO B/B	156
35650	BTL 18W-930-W	308	36224	GLOZO DSO G/B	156
35651	BTL 18W-930-B	308	36225	GLOZO DSO SR/B	156
35652	BTL 18W-940-W	308	36228	STRETON LED 20W NW	270
35653	BTL 18W-940-B	308	36229	STRETON LED 40W NW	270
35654	BTL 28W-930-W	308	36230	STRETON LED 60W NW	270
35655	BTL 28W-930-B	308	36231	STRETON LED 100W NW	270
35656	BTL 28W-940-W	308	36232	STRETON LED 150W NW	270
35657	BTL 28W-940-B	308	36233	STRETON LED 200W NW	270
35658	BTL 38W-930-W	308	36241	XLED G95 7W-WW	52
35659	BTL 38W-930-B	308	36242	XLED G95S 5,8W-NW	52
35660	BTL 38W-940-W	308	36243	XLED EX A60 4W-WW	43
35661	BTL 38W-940-B	308	36244	XLED EX A60 4W-NW	43
35662	BT LW 18W-930-W	309	36245	XLED EX A60 5W-WW	43
35663	BT LW 18W-930-B	309	36246	XLED EX A60 5W-NW	43
35664	BT LW 18W-940-W	309	36247	XLED EX A60 7,2W-WW	43
35665	BT LW 18W-940-B	309	36248	XLED EX A60 7,2W-NW	43
35670	TIBERI PRO 20W-940-W	250	36250	AGZAR E14 B	144
35671	TIBERI PRO 20W-940-B	250	36251	AGZAR E14 W	144
35672	TIBERI PRO 30W-940-W	250	36252	AGZAR C 3xE14 B	104
35673	TIBERI PRO 30W-940-B	250	36253	AGZAR C 3xE14 W	104
35674	TIBERI PRO 40W-940-W	250	36254	AGZAR EL-10 B	144
35675	TIBERI PRO 40W-940-B	250	36255	AGZAR EL-10 W	144
35676	TIBERI PRO NT20W-940W	251	36260	LARATA E27 W	145
35677	TIBERI PRO NT20W-940B	251	36261	LARATA E27 B	145
35678	TIBERI PRO NT30W-940W	251	36262	LARATA EL-10 W	145
35679	TIBERI PRO NT30W-940B	251	36263	LARATA EL-10 B	145
35688	EVALO EL-51 W-SR	126	36270	JUSI E27 W	151
35689	EVALO EL-51 B-SR	126	36271	JUSI E27 B	151
35690	EVALO EL-11 W-SR	126	36280	RAIBO E27 B	150
35691	EVALO EL-11 B-SR	126	36281	RAIBO E27 W	150
35692	EVALO EL-21 W-SR	126	36282	RAIBO E27 BL	150
35693	EVALO EL-21 B-SR	126	36283	RAIBO E27 Y	150
35694	EVALO EL-31 W-SR	126	36284	RAIBO E27 GN	150
35695	EVALO EL-31 B-SR	126	36285	RAIBO E27 PK	150
35696	EVALO EL-40 W-SR	126	36320	INITA LED IP54 GN	147
35697	EVALO EL-40 B-SR	126	36321	INITA LED IP54 B	147
35698	EVALO EL-41 W-SR	126	36322	INITA LED IP54 R	147
35699	EVALO EL-41 B-SR	126	36323	INITA LED IP54 Y	147
35750	GRL 6M5E27-B	301	36324	INITA LED IP54 W	147
35754	GRL 11M10E27-B	301	36331	K LED GU10 6W-NW	67
35758	GRL 15M15E27-B	301	36332	K LED GU10 6W-CW	67
35770	ERTON 140 OP-W	244	36333	K LED N GU10 6W-WW	67
35771	ERTON 240 OP-W	244	36381	ONTEC S M2302MSTW	344

INDEX PAR CODE
INDICE PER CODICE PRODOTTO

36382	ONTEC S M2302MATW	344	36631	ZEPO LFD-T02-W	202
36430	BERG AD-70	282	36632	ZEPO LFD-T02/S-B	202
36432	GRIBLO 7 GR	300	36633	ZEPO LFD-T02/S-W	202
36440	JASMIN 270-G/O	122	36640	AQILO E14 IP65 D50-GR	108
36441	JASMIN 370-G/O	122	36641	AQILO E14 IP65 D50-W	108
36442	JASMIN 470-G/O	122	36642	AQILO E14 IP65 D50-B	108
36443	JASMIN G/O-W	121	36643	AQILO E27 IP65 D50-GR	108
36460	RIFA LED 17,5W NW W/W	118	36644	AQILO E27 IP65 D50-W	108
36461	RIFA LED 17,5W WW W/W	118	36645	AQILO E27 IP65 D50-B	108
36462	RIFA LED 17,5W NW B/W	118	36650	AKVO IP44 15W-NW-W S	192
36463	RIFA LED 17,5W WW B/W	118	36651	AKVO IP44 15W-NW-B S	192
36464	RIFA LED 17,5W NW B/G	118	36652	AKVO IP44 15W-NW-C S	192
36465	RIFA LED 17,5W WW B/G	118	36653	AKVO IP44 20W-NW-W S	192
36466	RIFA LED 17,5W NW GR/G	118	36654	AKVO IP44 20W-NW-B S	192
36467	RIFA LED 17,5W WW GR/G	118	36655	AKVO IP44 20W-NW-C S	192
36468	RIFA LED 17,5W NW N1	118	36656	AKVO IP44 23W-NW-W S	192
36469	RIFA LED 17,5W WW N1	118	36657	AKVO IP44 23W-NW-B S	192
36499	JASMIN C 270-G/O	105	36658	AKVO IP44 23W-NW-C S	192
36500	JASMIN C 370-G/O	105	36659	AKVO IP44 15W-NW-W	193
36501	JASMIN C 470-G/O	105	36660	AKVO IP44 15W-NW-B	193
36502	JASMIN C 270-W/M	105	36661	AKVO IP44 15W-NW-C	193
36503	JASMIN C 370-W/M	105	36662	AKVO IP44 20W-NW-W	193
36504	JASMIN C 470-W/M	105	36663	AKVO IP44 20W-NW-B	193
36505	JASMIN C 270-B	105	36664	AKVO IP44 20W-NW-C	193
36506	JASMIN C 370-B	105	36665	AKVO IP44 23W-NW-W	193
36507	JASMIN C 470-B	105	36666	AKVO IP44 23W-NW-B	193
36510	TAVO LED DO 5W-NW	254	36666	AKVO IP44 23W-NW-C	193
36511	TAVO LED DO 9W-NW	254	36667	IQ-LED A60 3,4W-WW	40
36512	TAVO LED DO 12W-NW	254	36671	IQ-LED A60 3,4W-NW	40
36513	TAVO LED DO 18W-NW	254	36672	IQ-LED A60 3,4W-CW	40
36514	TAVO LED DO 24W-NW	254	36673	IQ-LED A60 5,9W-WW	40
36515	TAVO LED DL 5W-NW	254	36674	IQ-LED A60 5,9W-NW	40
36516	TAVO LED DL 9W-NW	254	36675	IQ-LED A60 5,9W-CW	40
36517	TAVO LED DL 12W-NW	254	36676	IQ-LED A60 7,8W-WW	40
36518	TAVO LED DL 18W-NW	254	36677	IQ-LED A60 7,8W-NW	40
36519	TAVO LED DL 24W-NW	254	36678	IQ-LED A60 7,8W-CW	40
36520	TAVO FRAME DO 12W	254	36679	IQ-LED A60 11W-WW	40
36521	TAVO FRAME DO 18W	254	36680	IQ-LED A60 11W-NW	40
36522	TAVO FRAME DL 12W	254	36681	IQ-LED A60 11W-CW	40
36523	TAVO FRAME DL 18W	254	36682	IQ-LED C35E14 3,4W-WW	56
36530	LIEGO 97 B	290	36683	IQ-LED C35E14 3,4W-NW	56
36531	LIEGO 89 PEND B	290	36684	IQ-LED C35E14 3,4W-VW	56
36532	LIEGO EL 28 UP B	290	36685	IQ-LED C35E14 5,9W-WW	56
36533	LIEGO EL 28 UP SE B	290	36686	IQ-LED C35E14 5,9W-NW	56
36534	LIEGO 37 B	290	36687	IQ-LED C35E14 5,9W-CW	56
36540	PRESO 80 GR	288	36688	IQ-LED G45E14 3,4W-WW	60
36541	PRESO 50 GR	288	36689	IQ-LED G45E14 3,4W-NW	60
36542	PRESO 30 GR	288	36690	IQ-LED G45E14 3,4W-CW	60
36543	PRESO EL 18 GR	288	36691	IQ-LED G45E27 3,4W-WW	60
36545	LAVEN 80 GR	287	36692	IQ-LED G45E27 3,4W-NW	60
36546	LAVEN 50 GR	287	36693	IQ-LED G45E27 3,4W-CW	60
36547	LAVEN EL 28 SE-GR	287	36694	IQ-LED G45E14 5,9W-WW	60
36548	LAVEN EL 25 GR	287	36695	IQ-LED G45E14 5,9W-NW	60
36550	PEVO 80 GR	286	36696	IQ-LED G45E14 5,9W-CW	60
36551	PEVO 50 GR	286	36697	IQ-LED G45E27 5,9W-WW	60
36552	PEVO EL 25 GR	286	36698	IQ-LED G45E27 5,9W-NW	60
36555	SELTO 80 B	289	36699	IQ-LED G45E27 5,9W-CW	60
36556	SELTO 50 B	289	37150	ARGUS II CT-2114-AN	182
36557	SELTO EL 23 B	289	37151	ARGUS II CT-2114-BR/M	182
36560	USTI SP 2X7 GR	298	37152	ARGUS II CT-2114-C	182
36561	USTI SP 1X7 GR	298	37153	ARGUS II CT-2114-C/M	182
36565	VORA SP 20 GR	299	37154	ARGUS II CT-2114-G	182
36566	VORA EL 20 GR	299	37155	ARGUS II CT-2114-GM	182
36570	ABETE LED 60 GR	285	37156	ARGUS II CT-2114-W	182
36571	ABETE LED 80 GR	285	37157	ARGUS II CT-2115-AN	182
36572	ABETE LED EL 20 GR	285	37158	ARGUS II CT-2115-BR/M	182
36573	ABETE LED EL 20 SE-GR	285	37159	ARGUS II CT-2115-C	182
36585	DASTO 2S0C FR B	302	37160	ARGUS II CT-2115-C/M	182
36586	NASTO 2S0C FR B	302	37161	ARGUS II CT-2115-G	182
36591	STONO 390 N	296	37162	ARGUS II CT-2115-GM	182
36592	STONO 490 N	296	37163	ARGUS II CT-2115-W	182
36593	STONO 585 N	296	37165	TINY BORD DTO-B	164
36594	STONO 780 N	296	37166	TINY BORD DTO-B/G	164
36605	FL SOLNAR SLR 8W NW-B	269	37167	TINY BORD DTO-W	164
36606	FL SONE SLR M NW-GR	268	37168	TINY BORD DTO-W/G	164
36607	FL SONE SLR L NW-GR	268	37170	BLINGO 34W 3740 60WW	208
36630	ZEPO LFD-T02-B	202	37171	BLINGO 34W 4080 60NW	208

INDEX PAR CODE

INDICE PER CODICE PRODOTTO

37172	BLINGO 34W 4080 60CW	208	37327	VAND LED 17,5W NW B	117
37173	BLINGO U34W 4080 60NW	208	37330	ARVOS LED 37W CCT B	120
37174	BLINGO 34W 4080 120NW	208	37331	ARVOS LED 37W CCT W	120
37175	BLINGO U34W 4080 120N	208	37335	SPN PANEL 60-62	209
37176	BLINGO 38W 4560 60NW	208	37335	SPN PANEL 60-62	211
37177	BLINGO 38W 4560 120NW	208	37336	SPN PANEL 120	209
37178	BLINGO 24W 4320 60NW	208	37336	SPN PANEL 120	211
37179	BLINGO U24W 4000 60NW	208	37337	CLIPS PANEL 60-62	209
37229	NEON MOUNTING CLIP	96	37337	CLIPS PANEL 60-62	211
37230	LCOB 10W/M 12 IP00-WW	83	37338	CLIPS PANEL 120	209
37231	LCOB 10W/M 12 IP00-NW	83	37338	CLIPS PANEL 120	211
37232	LCOB 10W/M 12 IP65-WW	83	37340	XLEDEX C35E14 3,8W-WW	57
37233	LCOB 10W/M 12 IP65-NW	83	37341	XLEDEX C35E14 3,8W-NW	57
37234	NEON LED12W/M IP65-WW	96	37342	XLEDEX G45E14 3,8W-WW	61
37235	NEON LED12W/M IP65-NW	96	37343	XLEDEX G45E14 3,8W-NW	61
37236	NEON LED12W/M IP65-CW	96	37344	XLEDEX G45E27 3,8W-WW	61
37237	NEON LED12W/M IP65-BL	96	37345	XLEDEX G45E27 3,8W-NW	61
37238	NEON END CAP HOLE	96	37346	XLED HP D90E27 26W-NW	98
37239	NEON END CAP	96	37347	XLED HP D46E40 38W-NW	98
37240	XLEDI M A60 E27 11W-WW	47	37360	SQMOTION-W	322
37241	XLEDI M A60 E27 11W-NW	47	37361	SQMOTION-B	322
37242	XLEDI M A60 E27 11W-CW	47	37362	ALER N-W	322
37243	XLEDI M A60 B22 12W-WW	48	37363	ALER N-B	322
37244	XLEDI M A60 B22 12W-CW	48	37364	ZONA MINI-W	323
37250	FELINE DSO B/B	158	37365	ZONA MINI-WT-W	323
37251	FELINE DSO G/B	158	37366	SENTO-O-WT-W	324
37252	FELINE DSO W/B	158	37367	SENTO-O-WT-B	324
37253	FELINE DSO W/W	158	37368	SENSQUARE-W	324
37254	FELINE DSO G/W	158	37369	SENSQUARE-B	324
37255	FELINE DSO B/W	158	37370	MERGE-WT-O-W	325
37256	FELINE DSL B/B	159	37380	XLED W A60 8,5W-WW	55
37257	FELINE DSL G/B	159	37381	XLED W ST 64 7W-WW	55
37258	FELINE DSL W/B	159	37382	XLED W C35E14 4,5W-WW	55
37259	FELINE DSL W/W	159	37383	XLED W G45E14 4,5W-WW	55
37260	FELINE DSL B/W	159	37390	CALIZA LED CCT W	142
37261	FELINE DSL G/W	159	37392	IRS3xAAA LED PIR W-NW	200
37265	BLINGO U E125LM 60NW	210	37393	HOFI LED WW W	141
37266	BLINGO U E125LM 120NW	210	37394	ORISA LED WW W	141
37267	BLINGO DRV42W DALI BK	211	37395	ORISA LED WW B	141
37267	BLINGO DRV42W DALI BK	211	37396	ULOV LED DIM WW W	140
37268	BLINGO DRV40W1-10V BK	211	37397	BOLA LED 2xUSB WW W	140
37268	BLINGO DRV40W1-10V BK	211	70522	MILO 7040T	245
37269	BLINGO DRV 32W ON-OFF	211	70523	MILO 7040T/P	245
37269	BLINGO DRV 32W ON-OFF	211	70524	HERMI 7063NB	245
37270	BLINGO DRV 40W ON-OFF	211	70525	INES 7061N	246
37270	BLINGO DRV 40W ON-OFF	211	70910	CYKLON EOL 100	338
37271	BLINGO U E125LM 30NW	210	70911	CYKLON EOL 100B	338
37272	BLINGO DRV 24W ON-OFF	211	70915	CYKLON EOL 120	338
37272	BLINGO DRV 24W ON-OFF	211	70916	CYKLON EOL 120B	338
37290	IPER LED 10W-NW-O	230	70920	CYKLON EOL 150	338
37291	IPER LED 19W-NW-O	230	70921	CYKLON EOL 150B	338
37292	IPER LED 26W-NW-O	230	70926	TWISTER AOL100B	337
37293	IPER LED 35W-NW-O	230	70936	CYKLON EOL 100HT	338
37294	IPER LED 10W-NW-L	230	70937	CYKLON EOL 100P	338
37295	IPER LED 19W-NW-L	230	70938	CYKLON EOL 100T	338
37296	IPER LED 26W-NW-L	230	70941	CYKLON EOL 120HT	338
37297	IPER LED 35W-NW-L	230	70942	CYKLON EOL 120P	338
37298	IPER LED 10W-NW-O-SE	230	70943	CYKLON EOL 120T	338
37299	IPER LED 19W-NW-O-SE	230	70947	CYKLON EOL 150P	338
37300	IPER LED 26W-NW-O-SE	230	70948	CYKLON EOL 150T	338
37301	IPER LED 35W-NW-O-SE	230	70953	TWISTER AOL100T	337
37302	IPER LED 10W-NW-L-SE	230	70956	TWISTER AOL120B	337
37303	IPER LED 19W-NW-L-SE	230	70960	TWISTER AOL120T	337
37304	IPER LED 26W-NW-L-SE	230	70961	WIR ZL100	337
37305	IPER LED 35W-NW-L-SE	230	70962	WIR ZL120	337
37310	FLUXY LED IP44 W	146	72109	HLD-R-GX5,3	343
37311	FLUXY LED IP44 B	146	72333	CLP-REGIS/PT	216
37312	FLUXY LED IP44 BL	146	72333	CLP-REGIS/PT	217
37313	FLUXY LED IP44 GN	146	72369	BR-GZ10	340
37314	FLUXY LED IP44 Y	146	xxx	ALIN LED	16
37320	LUMKO LED 17,5W NW	114	xxx	ALIN LED LINE	18
37321	CARVO LED 17,5W NW	114	xxx	ALIN 4LED	20
37322	BONSA LED 17,5W NW	115	xxx	ALIN 4LED LINE	22
37323	EXATE LED 17,5W NW	115	xxx	OFIS S LED	24
37324	SOLN LED 17,5W NW B/G	116	xxx	HIERRO LED	26
37325	AMAZI LED 17,5W NW B	116	xxx	FUTURIO LED	28
37326	VAND LED 17,5W NW W	117	xxx	ADTR	30

KANLUX SA

ul. Objazdowa 1 - 3, 41 - 922 Radzionków
POLSKA
tel. +48 32/388 74 00
fax +48 32/388 74 99
e-mail: kanlux@kanlux.pl

KANLUX LTD

2703 Sugar Mill Business Park,
Oakhurst Road, LS11 7HL Leeds
UNITED KINGDOM
salesuk@kanlux.com
tel.: +44 (0) 7725249456

KANLUX S.R.O.

Sadová 618, 738 01 Frýdek-Místek
ČESKÁ REPUBLIKA
tel. +420 558 402 511, 603 504 218
fax +420 558 694 250
e-mail: kanlux.cz@kanlux.cz

KANLUX S.R.O.

Zlatovská 2179/28, 911 05 Trenčín
SLOVENSKÁ REPUBLIKA
tel. +421 327 446 385-6
fax +421 327 446 387
e-mail: kanlux.sk@kanlux.sk

KANLUX KFT.

9026 Győr, Bácsai út 153/b
HUNGARY
tel. +36 96 525-467
fax +36 96 319-420
e-mail: info@kanlux.hu

ТОВ КАНЛЮКС

08130, Київська область,
Києво-Святошинський район,
с.Петропавлівська Борщагівка, вул. Соборна,
будинок 1-Б, офіс 617 УКРАЇНА
тел. +38 (044) 585 33 19
факс +38 (44) 585 33 18
e-mail: kanlux_ua@kanlux.com

KANLUX LITHUANIA and LATVIA DISTRIBUTION

tel. +37 065 693 649
e-mail: donatas.pliura@kanlux.com

KANLUX EOOD

Warehouse area Gopet Logistics, 1532 Kazichene, Sofia
BULGARIA
tel. +359 2 421 96 24
fax +359 2 421 96 23
e-mail: kanlux.bg@kanlux.com

KANLUX GMBH

Flugplatz 21, 44319 Dortmund
DEUTSCHLAND
Tel. +49 231 56557255
Fax +49 231 56557256
e-mail: kanlux.gmbh@kanlux.com

KANLUX LIGHTING SRL

Kanlux Lighting S.R.L.Oltenitei 249
Popesti Leordeni, 077160, Ilfov,
ROMANIA
tel. +40 371 474 133
e-mail: comenzi@kanlux.com

KANLUX FRANCE SAS

224 bis, rue Marcadet,
75018 Paris
France
tel. +33 (0) 9 86 23 98 61
e-mail: kanlux.fr@kanlux.com

KANLUX ITALY DISTRIBUTION

mob. +39 (0) 339 833 78 00
e-mail: kanlux.it@kanlux.com

more than
light.

AVIS JURIDIQUE

Cette publication a été préparée par Kanlux SA. En améliorant continuellement son offre et l'adaptant aux exigences du marché et de la législation, Kanlux SA se réserve le droit d'introduire des changements dans l'assortiment.

Cette publication ne constitue pas une offre au sens du Code civil. Les produits réels peuvent différer des photos d'illustration et des dessins contenus dans la publication.
Toutes les données incluses dans la publication sont valables à la date de publication, c'est-à-dire le 2 novembre 2023.

Kanlux SA n'est pas responsable du manque de disponibilité des produits inclus dans cette publication. Kanlux S.A. décline toute responsabilité pour tout dommage direct, indirect, accidentel ou autre (y compris, mais sans s'y limiter ou tout autre dommage, les pertes de bénéfices, les pertes de revenus ou les pertes d'exploitation ou pertes économiques similaires) résultant de l'utilisation des informations incluses dans cette publication.

Kanlux SA se réserve le droit de faire des erreurs et des modifications d'impression.

NOTA LEGITTIMA

Questa pubblicazione è stata preparata da Kanlux SA. Migliorando costantemente la sua offerta e adeguandola ai requisiti di mercato e legali Kanlux SA si riserva il diritto di introdurre cambiamenti nell'assortimento.

La pubblicazione presentata non costituisce un'offerta ai sensi del Codice Civile. I prodotti reali possono essere differenti dalle foto e dai disegni illustrativi della pubblicazione. Tutti i dati contenuti nella pubblicazione sono validi dal giorno di stampa, ovvero il 02 novembre 2023.

Kanlux SA non è responsabile per la mancanza di disponibilità dei prodotti inclusi in questa pubblicazione. Kanlux SA non è inoltre responsabile per eventuali danni diretti, indiretti o qualsiasi altro danno (inclusi, a titolo esemplificativo ma non esaustivo, mancati profitti, mancati guadagni o analoghe perdite economiche) derivanti dall'utilizzo delle informazioni contenute in questa pubblicazione.

Kanlux SA si riserva il diritto di errori e modifiche di stampa.



kanlux.com

