

A woman with long red hair, wearing a dark floral patterned top and red pants, stands and holds a tablet. She is smiling and looking towards a man sitting at a desk. The man has a beard and is wearing a light grey sweater. He is looking at the tablet and has his hand near his chin in a thoughtful pose. The background shows a modern office environment with large windows and industrial-style lighting. A blue diagonal shape is in the top left corner, and another blue diagonal shape is in the bottom left corner.

Kanlux

Catalogue

Factory
2024

more than
light.

more than
more than **light.**
light.



Professional research
and development centre

Specialised
production in Poland

Millions
of satisfied customers

35 years of experience



Professional
products for every
investment project.

Kanlux
FACTORY



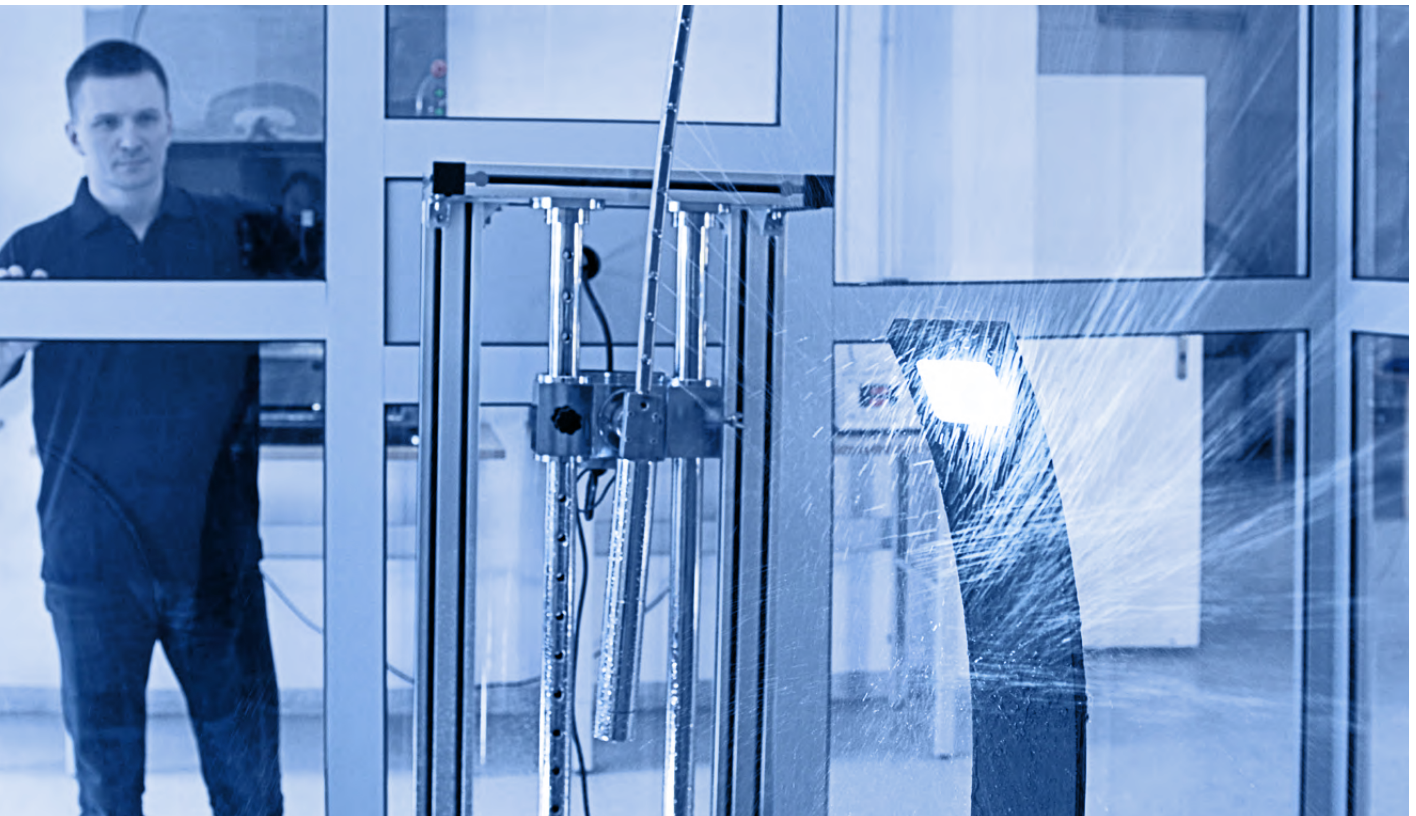



Kanlux LAB

The reliability of our products and **your safety** are our top priorities. This is why we have established the **Kanlux testing laboratory**. We carefully check all our designs and thoroughly examine their performance. Thanks to this, any Kanlux **product you buy is bound to meet your expectations**. We also provide you with support throughout your project, from purchase to after-sales service.





Kanlux
FACTORY

In-house production in Poland — our most powerful advantage that works in your favour. We can adapt the product to your investment project as required and manufacture it locally. Indeed, it is **Kanlux Factory** that allows us to quickly provide you with customised products. Our machinery and in-house powder coating **facility guarantee product repeatability** — no matter if you need 100 or 1,000 light fittings.



HIERRO LED

KANLUX HIERRO LED are fittings that have been developed with professionals in mind. Thanks to their excellent luminous parameters, they allow you to create energy-efficient and modern lighting systems. At the same time, they provide attractive visual effects through their unusual design.

The product is complemented by a variety of available control methods, enabling smart lighting management in any building.



ALIN

KANLUX ALIN was created with the ideal fitting in mind. Developed by Kanlux designers who combined innovation with more than 30 years of experience, KANLUX ALIN is made entirely in Poland, from the concept to the manufacturing, enabling us to easily customise it according to your specifications. Since it is a Kanlux-designed and manufactured product, we can tailor it to the individual requirements of each customer and each project. Confident in the reliability of KANLUX ALIN fittings, we offer you a 5-year guarantee as well.

OFIS

Kanlux **OFIS LED** is an ideal combination of effective lighting and state-of-the-art design. Manufactured at the Kanlux Factory in Poland using branded components, these fittings are fully customisable in terms of the expected parameters and functionality according to the customer's needs and the specific investment project. Sophisticated solutions simplify and accelerate assembly, and the casing's exceptionally low height facilitates installation in low-rise buildings.

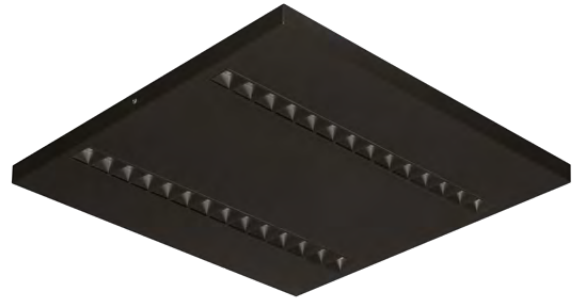

ADTR

KANLUX ADTR frames are designed for use with all Kanlux LED panels, as well as most LED panels on the market, enabling them to be surface mounted. Available in various colours and sizes, they come ready to use and do not require any prior assembly, saving time and providing an excellent visual effect.

Kanlux BRAVO, Kanlux BLINGO and Kanlux OFIS S are just some of our lighting fittings that can be successfully used with Kanlux ADTR frames.



FUTURIO

A series of LED hermetic fittings, **KANLUX FUTURIO LED** takes a leap into the future to meet the highest expectations. This top-tier quality product featuring impressive parameters and state-of-the-art optics is manufactured in Poland, at the Kanlux Factory.

FUTURIO LED is a pleasure to work with. Easy and quick access to its essential connection elements allows you to install it in less than 3 minutes.

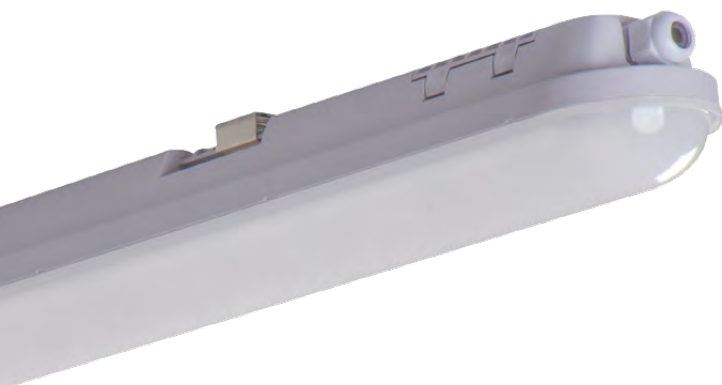

HIERRO LED

Linear LED fitting

Kanlux Hierro LED fittings have been developed with professionals in mind. Thanks to their outstanding luminous performance, they make it possible to create energy-efficient and modern lighting systems. At the same

time, they offer attractive visuals for your space thanks to their unusual design. The product is complemented by a variety of available control methods, enabling smart lighting management in any building.



HIERRO LED ... NTFX

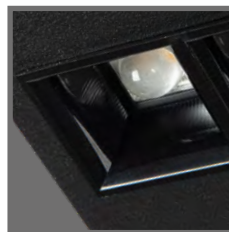

REDUCED
GLARE
THANKS
TO A NEW
GENERATION
LOUVRE



COLOUR COMBINATIONS POSSIBLE
OPTIONAL FLEX VERSIONS

Kanlux
FACTORY

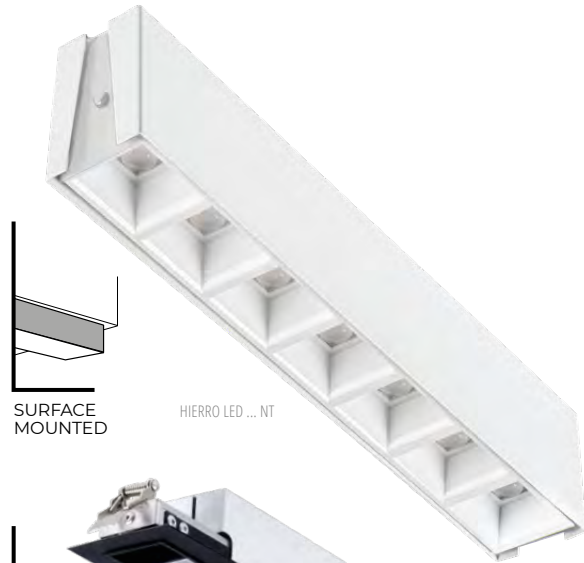

HIERRO LED ... NT + ALIN CORD + ROPE



HIERRO LED ... RM

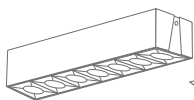

SURFACE MOUNTED

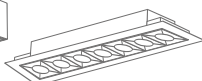

RECESSED

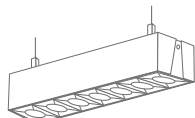

SURFACE MOUNTED WITH ROPES

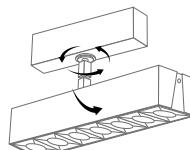

SURFACE MOUNTED, 340°, 90° FLEX

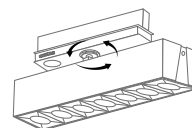

RAIL MOUNTED, STANDARD 340°

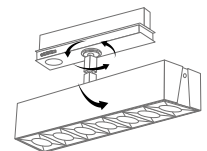

RAIL MOUNTED, FLEX 340°, 90°

► KEY

HR	HIERRO LED
HRD	HIERRO LED DALI
HRC	HIERRO LED CASAMBI READY
WW/830	Ra≥80 3000K
WN/835	Ra≥80 3500K
NW/840	Ra≥80 4000K
TW	TUNABLE WHITE design/ TUNABLE WHITE (CCT)
W	housing white
B	housing black
NT	surface
PT	recessed
HIERRO +ALIN CORD +ROPE	suspended mounted
RM	rail mounted
FX/FLEX	additional angle adjustment (to individual order)
S	length 300mm
M	length 600mm
L	length 900mm
SL	parameters 9W 1250lm 300mm version NT, PT, RM
SH	parameters 14W 1700lm 300mm version NT, PT, RM
ML	parameters 18W 2450lm 600mm version NT, PT
MM	parameters 23W 3000lm 600mm version NT, PT, RM
MH	parameters 28W 3450lm 600mm version NT, PT, RM
LL	parameters 23W 3150lm 900mm version NT, PT, RM
LM	parameters 32W 4200lm 900mm version NT, PT, RM
LH	parameters 42W 5150lm 900mm version NT, PT, RM



**We'll help you set up
your lighting the way
you want**

**CONFIGURE YOUR
PERFECT FITTING**

CONFIGURATOR



Use our configurator to create your perfect fitting, and we will manufacture it for you.



ALL THE CODES OF KANLUX FACTORY FIXTURES YOU CAN FIND IN THE KANLUX FACTORY CATALOGUE

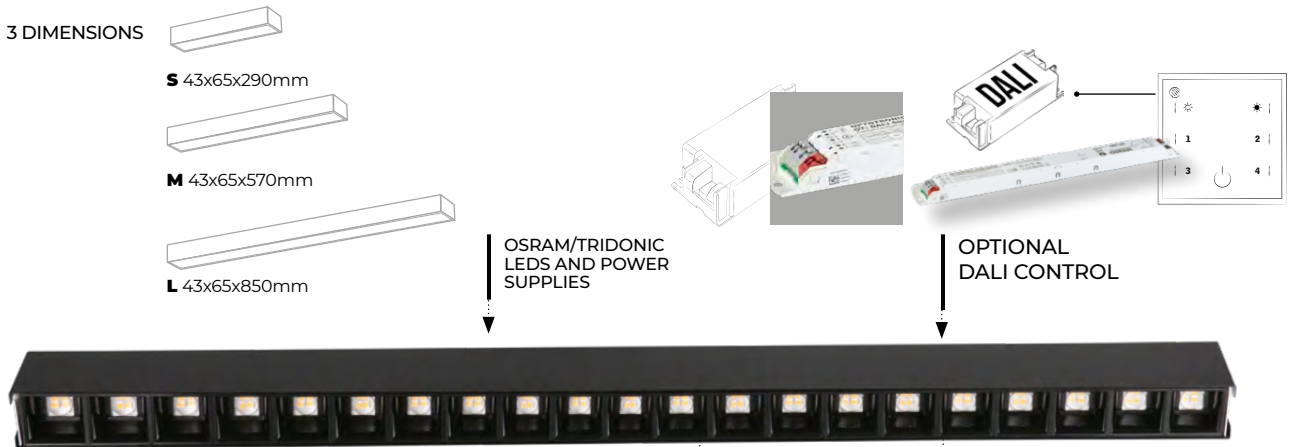

**TWO LOUVRE COLOURS AND MIX
VERSIONS AVAILABLE ON REQUEST**



WHITE BLACK WHITE/BLACK

**THREE LIGHT
COLOURS AND
OPTIONAL TUNABLE
WHITE VERSIONS**

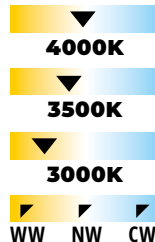

**FLEXIBLE
HOUSING COLOUR
CUSTOMISATION**

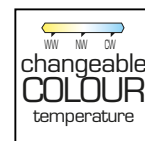

**OPTIONAL TUNABLE
WHITE VERSIONS**

HIERRO NT

36940	HR-SL-WW-W-NT	36942	HR-ML-WW-W-NT	36945	HR-LL-WW-W-NT	36988	HRD-ML-WW-W-NT	36991	HRD-LL-WW-W-NT
36941	HR-SH-WW-W-NT	36943	HR-MM-WW-W-NT	36946	HR-LM-WW-W-NT	36989	HRD-MM-WW-W-NT	36992	HRD-LM-WW-W-NT
36948	HR-SL-WW-B-NT	36944	HR-MH-WW-W-NT	36947	HR-LH-WW-W-NT	36990	HRD-MH-WW-W-NT	36993	HRD-LH-WW-W-NT
36949	HR-SH-WW-B-NT	36950	HR-ML-WW-B-NT	36953	HR-LL-WW-B-NT	36994	HRD-ML-WW-B-NT	36997	HRD-LL-WW-B-NT
36956	HR-SL-WN-W-NT	36951	HR-MM-WW-B-NT	36954	HR-LM-WW-B-NT	36995	HRD-MM-WW-B-NT	36998	HRD-LM-WW-B-NT
36957	HR-SH-WN-W-NT	36952	HR-MH-WW-B-NT	36955	HR-LH-WW-B-NT	36996	HRD-MH-WW-B-NT	36999	HRD-LH-WW-B-NT
36964	HR-SL-WN-B-NT	36958	HR-ML-WN-W-NT	36961	HR-LL-WN-W-NT	37000	HRD-ML-WN-W-NT	37003	HRD-LL-WN-W-NT
36965	HR-SH-WN-B-NT	36959	HR-MM-WN-W-NT	36962	HR-LM-WN-W-NT	37001	HRD-MM-WN-W-NT	37004	HRD-LM-WN-W-NT
36972	HR-SL-NW-W-NT	36960	HR-MH-WN-W-NT	36963	HR-LH-WN-W-NT	37002	HRD-MH-WN-W-NT	37005	HRD-LH-WN-W-NT
36973	HR-SH-NW-W-NT	36966	HR-ML-WN-B-NT	36969	HR-LL-WN-B-NT	37006	HRD-ML-WN-B-NT	37009	HRD-LL-WN-B-NT
36980	HR-SL-NW-B-NT	36967	HR-MM-WN-B-NT	36970	HR-LM-WN-B-NT	37007	HRD-MM-WN-B-NT	37010	HRD-LM-WN-B-NT
36981	HR-SH-NW-B-NT	36968	HR-MH-WN-B-NT	36971	HR-LH-WN-B-NT	37008	HRD-MH-WN-B-NT	37011	HRD-LH-WN-B-NT
		36974	HR-ML-NW-W-NT	36977	HR-LL-NW-W-NT	37012	HRD-ML-NW-W-NT	37015	HRD-LL-NW-W-NT
		36975	HR-MM-NW-W-NT	36978	HR-LM-NW-W-NT	37013	HRD-MM-NW-W-NT	37016	HRD-LM-NW-W-NT
		36976	HR-MH-NW-W-NT	36979	HR-LH-NW-W-NT	37014	HRD-MH-NW-W-NT	37017	HRD-LH-NW-W-NT
		36982	HR-ML-NW-B-NT	36985	HR-LL-NW-B-NT	37018	HRD-ML-NW-B-NT	37021	HRD-LL-NW-B-NT
		36983	HR-MM-NW-B-NT	36986	HR-LM-NW-B-NT	37019	HRD-MM-NW-B-NT	37022	HRD-LM-NW-B-NT
		36984	HR-MH-NW-B-NT	36987	HR-LH-NW-B-NT	37020	HRD-MH-NW-B-NT	37023	HRD-LH-NW-B-NT

HIERRO RM

37108	HR-SL-WW-W-RM	37143	HR-SL-NW-B-RM	37114	HR-LH-WW-W-RM
37109	HR-SH-WW-W-RM	37144	HR-SH-NW-B-RM	37119	HR-LL-WW-B-RM
37115	HR-SL-WW-B-RM	37110	HR-MM-WW-W-RM	37120	HR-LM-WW-B-RM
37116	HR-SH-WW-B-RM	37111	HR-MH-WW-W-RM	37121	HR-LH-WW-B-RM
37122	HR-SL-WN-W-RM	37117	HR-MM-WW-B-RM	37126	HR-LL-WN-W-RM
37123	HR-SH-WN-W-RM	37118	HR-MH-WW-B-RM	37127	HR-LM-WN-W-RM
37129	HR-SL-WN-B-RM	37124	HR-MM-WN-W-RM	37128	HR-LH-WN-W-RM
37130	HR-SH-WN-B-RM	37125	HR-MH-WN-W-RM	37133	HR-LL-WN-B-RM
37136	HR-SL-NW-W-RM	37131	HR-MM-WN-B-RM	37134	HR-LM-WN-B-RM
37137	HR-SH-NW-W-RM	37132	HR-MH-WN-B-RM	37135	HR-LH-WN-B-RM
		37138	HR-MM-NW-W-RM	37140	HR-LL-NW-W-RM
		37139	HR-MH-NW-W-RM	37141	HR-LM-NW-W-RM
		37145	HR-MM-NW-B-RM	37142	HR-LH-NW-W-RM
		37146	HR-MH-NW-B-RM	37147	HR-LL-NW-B-RM
		37112	HR-LL-WW-W-RM	37148	HR-LM-NW-B-RM
		37113	HR-LM-WW-W-RM	37149	HR-LH-NW-B-RM

HIERRO PT

37024	HR-SL-WW-W-PT	37058	HR-ML-NW-W-PT	37084	HRD-ML-WN-W-PT
37025	HR-SH-WW-W-PT	37059	HR-MM-NW-W-PT	37085	HRD-MM-WN-W-PT
37032	HR-SL-WW-B-PT	37060	HR-MH-NW-W-PT	37086	HRD-MH-WN-W-PT
37033	HR-SH-WW-B-PT	37066	HR-ML-NW-B-PT	37090	HRD-ML-WN-B-PT
37040	HR-SL-WN-W-PT	37067	HR-MM-NW-B-PT	37091	HRD-MM-WN-B-PT
37041	HR-SH-WN-W-PT	37068	HR-MH-NW-B-PT	37092	HRD-MH-WN-B-PT
37048	HR-SL-WN-B-PT	37029	HR-LL-WW-W-PT	37096	HRD-ML-NW-W-PT
37049	HR-SH-WN-B-PT	37030	HR-LM-WW-W-PT	37097	HRD-MM-NW-W-PT
37056	HR-SL-NW-W-PT	37031	HR-LH-WW-W-PT	37098	HRD-MH-NW-W-PT
37057	HR-SH-NW-W-PT	37037	HR-LL-WW-B-PT	37102	HRD-ML-NW-B-PT
37064	HR-SL-NW-B-PT	37038	HR-LM-WW-B-PT	37103	HRD-MM-NW-B-PT
37065	HR-SH-NW-B-PT	37039	HR-LH-WW-B-PT	37104	HRD-MH-NW-B-PT
37026	HR-ML-WW-W-PT	37045	HR-LL-WN-W-PT	37075	HRD-LL-WW-W-PT
37027	HR-MM-WW-W-PT	37046	HR-LM-WN-W-PT	37076	HRD-LM-WW-W-PT
37028	HR-MH-WW-W-PT	37047	HR-LH-WN-W-PT	37077	HRD-LH-WW-W-PT
37034	HR-ML-WW-B-PT	37053	HR-LL-WN-B-PT	37081	HRD-LL-WW-B-PT
37035	HR-MM-WW-B-PT	37054	HR-LM-WN-B-PT	37082	HRD-LM-WW-B-PT
37036	HR-MH-WW-B-PT	37055	HR-LH-WN-B-PT	37083	HRD-LH-WW-B-PT
37042	HR-ML-WN-W-PT	37061	HR-LL-NW-W-PT	37087	HRD-LL-WN-W-PT
37043	HR-MM-WN-W-PT	37062	HR-LM-NW-W-PT	37088	HRD-LM-WN-W-PT
37044	HR-MH-WN-W-PT	37063	HR-LH-NW-W-PT	37089	HRD-LH-WN-W-PT
37050	HR-ML-WN-B-PT	37069	HR-LL-NW-B-PT	37093	HRD-LL-WN-B-PT
37051	HR-MM-WN-B-PT	37070	HR-LM-NW-B-PT	37094	HRD-LM-WN-B-PT
37052	HR-MH-WN-B-PT	37071	HR-LH-NW-B-PT	37095	HRD-LH-WN-B-PT
		37072	HRD-ML-WW-W-PT	37099	HRD-LL-NW-W-PT
		37073	HRD-MM-WW-W-PT	37100	HRD-LM-NW-W-PT
		37074	HRD-MH-WW-W-PT	37101	HRD-LH-NW-W-PT
		37078	HRD-ML-WW-B-PT	37105	HRD-LL-NW-B-PT
		37079	HRD-MM-WW-B-PT	37106	HRD-LM-NW-B-PT
		37080	HRD-MH-WW-B-PT	37107	HRD-LH-NW-B-PT



ALIN LED | ALIN LED LINE

Linear LED fitting

Kanlux ALIN LED are fittings that have been created with ideal lighting in mind. Created by Kanlux designers who combined innovation with over 30 years of experience, ALIN fittings offer branded components and perfect build quality, ensuring perfect aesthetics and durability for many years. Thanks to

a wide range of models, you are bound to find the perfect match for your investment project.

ALIN LED products are covered by a 5-year Warranty. For Warranty T&Cs, see the warranty statement at www.kanlux.com.

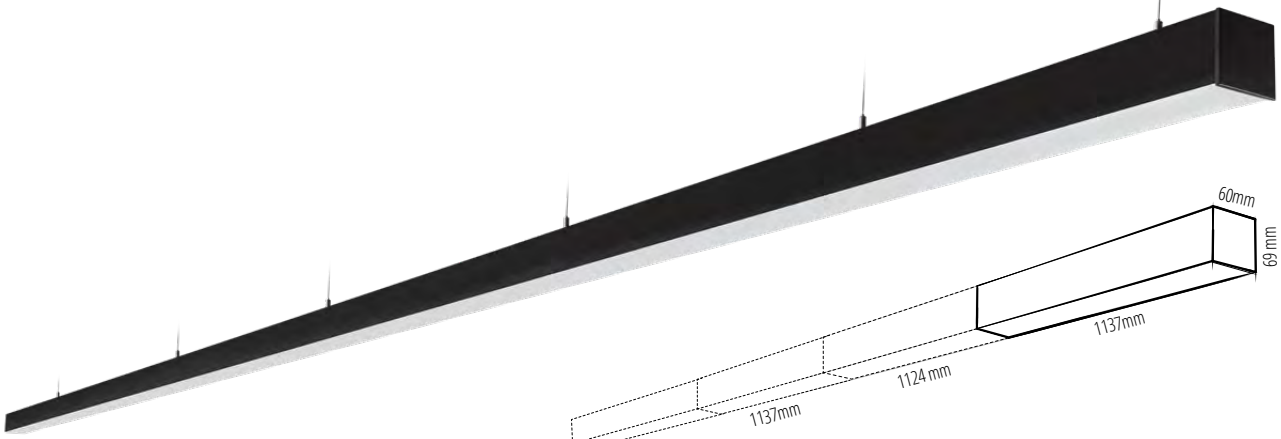

UNLIMITED LED
LIGHT LINE LENGTH



1120MM ALIN LED FITTINGS
CAN BE LINKED INTO LINES

Kanlux
FΔCTORY

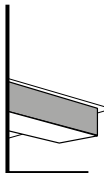

SURFACE MOUNTED

ALIN LED ... NT

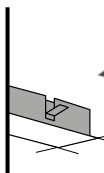

RECESSED

ALIN LED ... PT

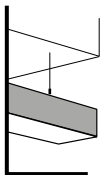

SUSPENDED MOUNT



ALIN LED ... NT + ALIN CORD + ROPE

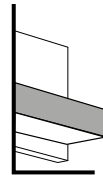

WALL MOUNTED



ALIN LED ... NT + ALIN GRIP

► KEY

AL	KANLUX ALIN LED
ALD	KANLUX ALIN LED DALI
S	580mm
M	1140mm
L	1700mm
S	ultra low power
L	low power
M	medium power
H	high power
WW	3000K Ra ≥ 80
NW	4000K Ra ≥ 80
MAT	matte lampshade
MPR	microprismatic lampshade
W	housing: white
B	housing: black
S	housing: silver
PT	recessed
NT	surface mounted
SE	motion sensor version
TW	tunable white
AS	asymmetric optics
ALIN +ALIN CORD +ROPE	suspended mount version
ALIN +ALIN NT GRIP	wall mounted version



**We'll help you set up
your lighting the way
you want**

**CONFIGURE YOUR
PERFECT FITTING**

CONFIGURATOR



Use our configurator to create your perfect fitting, and we will manufacture it for you.

		MAT		MPR	
		WW (830)	NW (840)	WW (830)	NW (840)
SL	10W	1150LM	1300LM	1050LM	1200LM
SH	19W	2250LM	2550LM	2050LM	2350LM
MS	18W	2150LM	2400LM	2050LM	2250LM
ML	25W	2980LM	3250LM	2750LM	3000LM
MM	29W	3450LM	3900LM	3170LM	3600LM
MH	40W	4500LM	5050LM	4150LM	4650LM
LL	33W	4100LM	4550LM	3750LM	4150LM
LH	52W	5600LM	6300LM	5150LM	5800LM

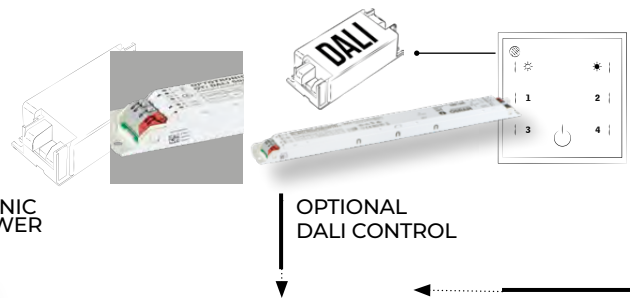

WHAT MAKES US SPECIAL?

TWO LIGHT COLOURS AND OPTIONAL TUNABLE WHITE VERSIONS

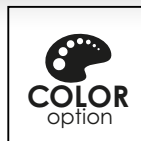
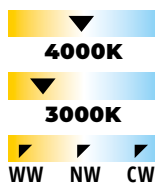

FLEXIBLE HOUSING COLOUR CUSTOMISATION

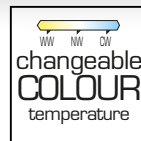

OPTIONAL TUNABLE WHITE VERSIONS

TWO DIFFUSER VARIANTS

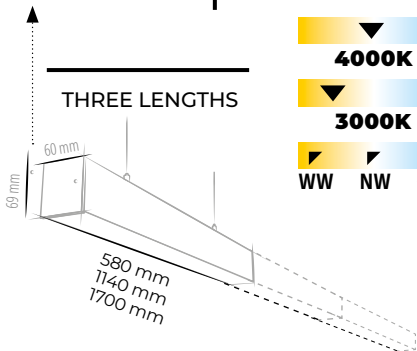
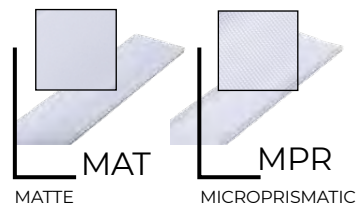

AL LED NT

33900	AL-SL-NW-MAT-W-NT	33984	AL-ML-NW-MAT-B-NT	34096	AL-LL-NW-MPR-B-NT	34228	ALD-ML-NW-MPR-W-NT	34344	ALD-LL-NW-MAT-B-NT
33901	AL-SH-NW-MAT-W-NT	33985	AL-MH-NW-MAT-B-NT	34097	AL-LH-NW-MPR-B-NT	34229	ALD-MH-NW-MPR-W-NT	34345	ALD-LH-NW-MAT-B-NT
33902	AL-SL-WW-MAT-W-NT	33986	AL-ML-WW-MAT-B-NT	34098	AL-LL-WW-MPR-B-NT	34230	ALD-ML-WW-MPR-W-NT	34346	ALD-LL-WW-MAT-B-NT
33903	AL-SH-WW-MAT-W-NT	33987	AL-MH-WW-MAT-B-NT	34099	AL-LH-WW-MPR-B-NT	34231	ALD-MH-WW-MPR-W-NT	34347	ALD-LH-WW-MAT-B-NT
33904	AL-SL-NW-MPR-W-NT	33988	AL-ML-NW-MPR-B-NT	34104	AL-LL-NW-MAT-S-NT	34236	ALD-ML-NW-MAT-B-NT	34348	ALD-LL-NW-MPR-B-NT
33905	AL-SH-NW-MPR-W-NT	33989	AL-MH-NW-MPR-B-NT	34105	AL-LH-NW-MAT-S-NT	34237	ALD-MH-NW-MAT-B-NT	34349	ALD-LH-NW-MPR-B-NT
33906	AL-SL-WW-MPR-W-NT	33990	AL-ML-WW-MPR-B-NT	34106	AL-LL-WW-MAT-S-NT	34238	ALD-ML-WW-MAT-B-NT	34350	ALD-LL-WW-MPR-B-NT
33907	AL-SH-WW-MPR-W-NT	33991	AL-MH-WW-MPR-B-NT	34107	AL-LH-WW-MAT-S-NT	34239	ALD-MH-WW-MAT-B-NT	34351	ALD-LH-WW-MPR-B-NT
33912	AL-SL-NW-MAT-B-NT	33996	AL-ML-NW-MAT-S-NT	34108	AL-LL-NW-MPR-S-NT	34240	ALD-ML-NW-MPR-B-NT	34356	ALD-LL-NW-MAT-S-NT
33913	AL-SH-NW-MAT-B-NT	33997	AL-MH-NW-MAT-S-NT	34109	AL-LH-NW-MPR-S-NT	34241	ALD-MH-NW-MPR-B-NT	34357	ALD-LH-NW-MAT-S-NT
33914	AL-SL-WW-MAT-B-NT	33998	AL-ML-WW-MAT-S-NT	34110	AL-LL-WW-MPR-S-NT	34242	ALD-ML-WW-MPR-B-NT	34358	ALD-LL-WW-MAT-S-NT
33915	AL-SH-WW-MAT-B-NT	33999	AL-MH-WW-MAT-S-NT	34111	AL-LH-WW-MPR-S-NT	34243	ALD-MH-WW-MPR-B-NT	34359	ALD-LH-WW-MAT-S-NT
33916	AL-SL-NW-MPR-B-NT	34000	AL-ML-NW-MPR-S-NT	34152	ALD-SL-NW-MAT-W-NT	34248	ALD-ML-NW-MAT-S-NT	34360	ALD-LL-NW-MPR-S-NT
33917	AL-SH-NW-MPR-B-NT	34001	AL-MH-NW-MPR-S-NT	34153	ALD-SH-NW-MAT-W-NT	34249	ALD-MH-NW-MAT-S-NT	34361	ALD-LH-NW-MPR-S-NT
33918	AL-SL-WW-MPR-B-NT	34002	AL-ML-WW-MPR-S-NT	34154	ALD-SL-WW-MAT-W-NT	34250	ALD-ML-WW-MAT-S-NT	34362	ALD-LL-WW-MPR-S-NT
33919	AL-SH-WW-MPR-B-NT	34003	AL-MH-WW-MPR-S-NT	34155	ALD-SH-WW-MAT-W-NT	34251	ALD-MH-WW-MAT-S-NT	34363	ALD-LH-WW-MPR-S-NT
33924	AL-SL-NW-MAT-S-NT	34004	AL-MM-NW-MAT-W-NT	34156	ALD-SL-NW-MPR-W-NT	34252	ALD-ML-NW-MPR-S-NT	35592	ALD-MS-NW-MAT-B-NT
33925	AL-SH-NW-MAT-S-NT	34005	AL-MM-WW-MAT-W-NT	34157	ALD-SH-NW-MPR-W-NT	34253	ALD-MH-NW-MPR-S-NT	35596	ALD-MS-NW-MAT-S-NT
33926	AL-SL-WW-MAT-S-NT	34006	AL-MM-NW-MPR-W-NT	34158	ALD-SL-WW-MPR-W-NT	34254	ALD-ML-WW-MPR-S-NT	35588	ALD-MS-NW-MAT-W-NT
33927	AL-SH-WW-MAT-S-NT	34007	AL-MM-WW-MPR-W-NT	34159	ALD-SH-WW-MPR-W-NT	34255	ALD-MH-WW-MPR-S-NT	35594	ALD-MS-NW-MPR-B-NT
33928	AL-SL-NW-MPR-S-NT	34050	AL-MM-NW-MAT-B-NT	34164	ALD-SL-NW-MAT-B-NT	34296	ALD-MM-NW-MAT-W-NT	35598	ALD-MS-NW-MPR-S-NT
33929	AL-SH-NW-MPR-S-NT	34051	AL-MM-WW-MAT-B-NT	34165	ALD-SH-NW-MAT-B-NT	34297	ALD-MM-WW-MAT-W-NT	35590	ALD-MS-NW-MPR-W-NT
33930	AL-SL-WW-MPR-S-NT	34052	AL-MM-NW-MPR-B-NT	34166	ALD-SL-WW-MAT-B-NT	34298	ALD-MM-NW-MPR-W-NT	35593	ALD-MS-WW-MAT-B-NT
33931	AL-SH-WW-MPR-S-NT	34053	AL-MM-WW-MPR-B-NT	34167	ALD-SH-WW-MAT-B-NT	34299	ALD-MM-WW-MPR-W-NT	35597	ALD-MS-WW-MAT-S-NT
33932	AL-SL-NW-MAT-S-NT	34056	AL-MM-NW-MAT-S-NT	34168	ALD-SL-NW-MPR-B-NT	34302	ALD-MM-NW-MAT-B-NT	35589	ALD-MS-WW-MAT-W-NT
33933	AL-SH-NW-MAT-S-NT	34057	AL-MM-WW-MAT-S-NT	34169	ALD-SH-NW-MPR-B-NT	34303	ALD-MM-WW-MAT-B-NT	35595	ALD-MS-WW-MPR-B-NT
33934	AL-SL-WW-MAT-S-NT	34058	AL-MM-NW-MPR-S-NT	34170	ALD-SL-WW-MPR-B-NT	34304	ALD-MM-NW-MPR-B-NT	35599	ALD-MS-WW-MPR-S-NT
33935	AL-SH-WW-MAT-S-NT	34059	AL-MM-WW-MPR-S-NT	34171	ALD-SH-WW-MPR-B-NT	34305	ALD-MM-WW-MPR-B-NT	35591	ALD-MS-WW-MPR-W-NT
33936	AL-SL-NW-MPR-S-NT	34080	AL-LL-NW-MAT-W-NT	34176	ALD-SL-NW-MAT-S-NT	34308	ALD-MM-NW-MAT-S-NT	35604	ALD-MS-NW-MAT-B-NT
33937	AL-SH-NW-MPR-S-NT	34081	AL-LH-NW-MAT-W-NT	34177	ALD-SH-NW-MAT-S-NT	34309	ALD-MM-WW-MAT-S-NT	35608	ALD-MS-NW-MAT-S-NT
33938	AL-SL-WW-MPR-S-NT	34082	AL-LL-WW-MAT-W-NT	34178	ALD-SL-WW-MAT-S-NT	34310	ALD-MM-NW-MPR-S-NT	35600	ALD-MS-NW-MAT-W-NT
33939	AL-SH-WW-MPR-S-NT	34083	AL-LH-WW-MAT-W-NT	34179	ALD-SH-WW-MAT-S-NT	34311	ALD-MM-WW-MPR-S-NT	35606	ALD-MS-NW-MPR-B-NT
33940	AL-SL-NW-MAT-W-NT	34084	AL-LL-NW-MPR-W-NT	34180	ALD-SL-NW-MPR-S-NT	34332	ALD-LL-NW-MAT-W-NT	35610	ALD-MS-NW-MPR-S-NT
33941	AL-SH-NW-MAT-W-NT	34085	AL-LH-NW-MPR-W-NT	34181	ALD-SH-NW-MPR-S-NT	34333	ALD-LH-NW-MAT-W-NT	35602	ALD-MS-NW-MPR-W-NT
33942	AL-SL-WW-MAT-W-NT	34086	AL-LL-WW-MPR-W-NT	34182	ALD-SL-WW-MPR-S-NT	34334	ALD-LL-WW-MAT-W-NT	35605	ALD-MS-WW-MAT-B-NT
33943	AL-SH-WW-MAT-W-NT	34087	AL-LH-WW-MPR-W-NT	34183	ALD-SH-WW-MPR-S-NT	34335	ALD-LH-WW-MAT-W-NT	35609	ALD-MS-WW-MAT-S-NT
33944	AL-SL-NW-MPR-W-NT	34092	AL-LL-NW-MAT-B-NT	34224	ALD-SL-NW-MPR-B-NT	34336	ALD-LL-NW-MPR-W-NT	35601	ALD-MS-NW-MAT-W-NT
33945	AL-SH-NW-MPR-W-NT	34093	AL-LH-NW-MAT-B-NT	34225	ALD-SH-NW-MPR-B-NT	34337	ALD-LH-NW-MPR-W-NT	35607	ALD-MS-WW-MPR-B-NT
33946	AL-SL-WW-MAT-B-NT	34094	AL-LL-WW-MAT-B-NT	34226	ALD-SL-WW-MAT-W-NT	34338	ALD-LL-WW-MPR-W-NT	35611	ALD-MS-WW-MPR-S-NT
33947	AL-SH-WW-MAT-B-NT	34095	AL-LH-WW-MAT-B-NT	34227	ALD-SH-WW-MAT-W-NT	34339	ALD-LH-WW-MPR-W-NT	35603	ALD-MS-WW-MPR-W-NT

ACCESSORIES

32540	ALIN CORD 1F-W	32542	ALIN CORD 1F-SR	32544	ALIN CORD DALI 1F-B	29557	ALIN-NT-GRIP
32541	ALIN CORD 1F-B	32543	ALIN CORD DALI 1F-W	32545	ALIN CORD DALI 1F-SR	7871	ROPE-NT-150-SINGLE

AL LED PT

33936	AL-SL-NW-MAT-W-PT	34020	AL-ML-NW-MAT-B-PT	34132	AL-LL-NW-MPR-B-PT	34264	ALD-ML-NW-MPR-W-PT	34380	ALD-LL-NW-MAT-B-PT
33937	AL-SH-NW-MAT-W-PT	34021	AL-MH-NW-MAT-B-PT	34133	AL-LH-NW-MPR-B-PT	34265	ALD-MH-NW-MPR-W-PT	34381	ALD-LH-NW-MAT-B-PT
33938	AL-SL-WW-MAT-W-PT	34022	AL-ML-WW-MAT-B-PT	34134	AL-LL-WW-MPR-B-PT	34266	ALD-ML-WW-MPR-W-PT	34382	ALD-LL-WW-MAT-B-PT
33939	AL-SH-WW-MAT-W-PT	34023	AL-MH-WW-MAT-B-PT	34135	AL-LH-WW-MPR-B-PT	34267	ALD-MH-WW-MPR-W-PT	34383	ALD-LH-WW-MAT-B-PT
33940	AL-SL-NW-MPR-W-PT	34024	AL-ML-NW-MPR-B-PT	34140	AL-LL-NW-MAT-S-PT	34272	ALD-ML-NW-MAT-B-PT	34384	ALD-LL-NW-MPR-B-PT
33941	AL-SH-NW-MPR-W-PT	34025	AL-MH-NW-MPR-B-PT	34141	AL-LH-NW-MAT-S-PT	34273	ALD-MH-NW-MAT-B-PT	34385	ALD-LH-NW-MPR-B-PT
33942	AL-SL-WW-MPR-W-PT	34026	AL-ML-WW-MPR-B-PT	34142	AL-LL-WW-MAT-S-PT	34274	ALD-ML-WW-MAT-B-PT	34386	ALD-LL-WW-MPR-B-PT
33943	AL-SH-WW-MPR-W-PT	34027	AL-MH-WW-MPR-B-PT	34143	AL-LH-WW-MAT-S-PT	34275	ALD-MH-WW-MAT-B-PT	34387	ALD-LH-WW-MPR-B-PT
33944	AL-SL-NW-MAT-B-PT	34032	AL-ML-NW-MAT-S-PT	34144	AL-LL-NW-MPR-S-PT	34276	ALD-ML-NW-MPR-B-PT	34392	ALD-LL-NW-MAT-S-PT
33945	AL-SH-NW-MAT-B-PT	34033	AL-MH-NW-MAT-S-PT	34145	AL-LH-NW-MPR-S-PT	34277	ALD-MH-NW-MPR-B-PT	34393	ALD-LH-NW-MAT-S-PT
33946	AL-SL-WW-MAT-B-PT	34034	AL-ML-WW-MAT-S-PT	34146	AL-LL-WW-MPR-S-PT	34278	ALD-ML-WW-MPR-B-PT	34394	ALD-LL-WW-MAT-S-PT
33947	AL-SH-WW-MAT-B-PT	34035	AL-MH-WW-MAT-S-PT	34147	AL-LH-WW-MPR-S-PT	34279	ALD-MH-WW-MPR-B-PT	34395	ALD-LH-WW-MAT-S-PT
33948	AL-SL-NW-MPR-B-PT	34036	AL-ML-NW-MPR-S-PT	34188	ALD-SL-NW-MAT-W-PT	34284	ALD-ML-NW-MAT-S-PT	34396	ALD-LL-NW-MPR-S-PT
33949	AL-SH-NW-MPR-B-PT	34037	AL-MH-NW-MPR-S-PT	34189	ALD-SH-NW-MAT-W-PT	34285	ALD-MH-NW-MAT-S-PT	34397	ALD-LH-NW-MPR-S-PT
33950	AL-SL-WW-MPR-B-PT	34038	AL-ML-WW-MPR-S-PT	34190	ALD-SL-WW-MAT-W-PT	34286	ALD-ML-WW-MAT-S-PT	34398	ALD-LL-WW-MPR-S-PT
33951	AL-SH-WW-MPR-B-PT	34039	AL-MH-WW-MPR-S-PT	34191	ALD-SH-WW-MAT-W-PT	34287	ALD-MH-WW-MAT-S-PT	34399	ALD-LH-WW-MPR-S-PT
33952	AL-SL-NW-MAT-S-PT	34062	AL-MM-NW-MAT-W-PT	34192	ALD-SL-NW-MPR-W-PT	34288	ALD-ML-NW-MPR-S-PT	35616	ALD-MS-NW-MAT-B-PT
33953	AL-SH-NW-MAT-S-PT	34063	AL-MM-WW-MAT-W-PT	34193	ALD-SH-NW-MPR-W-PT	34289	ALD-MH-NW-MPR-S-PT	35620	ALD-MS-NW-MAT-S-PT
33954	AL-SL-WW-MAT-S-PT	34064	AL-MM-NW-MPR-W-PT	34194	ALD-SL-WW-MPR-W-PT	34290	ALD-ML-WW-MPR-S-PT	35612	ALD-MS-NW-MPR-B-PT
33955	AL-SH-WW-MAT-S-PT	34065	AL-MM-WW-MPR-W-PT	34195	ALD-SH-WW-MPR-W-PT	34291	ALD-MH-WW-MPR-S-PT	35618	ALD-MS-NW-MPR-B-PT
33956	AL-SL-NW-MPR-B-PT	34068	AL-MM-NW-MAT-B-PT	34200	ALD-SL-NW-MAT-B-PT	34314	ALD-MM-NW-MAT-W-PT	35622	ALD-MS-NW-MPR-S-PT
33957	AL-SH-NW-MPR-B-PT	34069	AL-MM-WW-MAT-B-PT	34201	ALD-SH-NW-MAT-B-PT	34315	ALD-MM-WW-MAT-W-PT	35614	ALD-MS-NW-MPR-W-PT
33958	AL-SL-WW-MPR-B-PT	34070	AL-MM-NW-MPR-B-PT	34202	ALD-SL-WW-MAT-B-PT	34316	ALD-MM-WW-MPR-W-PT	35617	ALD-MS-WW-MAT-B-PT
33959	AL-SH-WW-MPR-B-PT	34071	AL-MM-WW-MPR-B-PT	34203	ALD-SH-WW-MAT-B-PT	34317	ALD-MM-WW-MPR-W-PT	35621	ALD-MS-WW-MAT-S-PT
33960	AL-SL-NW-MAT-S-PT	34074	AL-MM-NW-MAT-S-PT	34204	ALD-SL-NW-MPR-B-PT	34320	ALD-MM-NW-MAT-B-PT	35613	ALD-MS-WW-MAT-W-PT
33961	AL-SH-NW-MAT-S-PT	34075	AL-MM-WW-MAT-S-PT	34205	ALD-SH-NW-MPR-B-PT	34321	ALD-MM-WW-MAT-B-PT	35619	ALD-MS-WW-MPR-B-PT
33962	AL-SL-WW-MAT-S-PT	34076	AL-MM-NW-MPR-S-PT	34206	ALD-SL-WW-MPR-B-PT	34322	ALD-MM-WW-MPR-B-PT	35623	ALD-MS-WW-MPR-B-PT
33963	AL-SH-WW-MAT-S-PT	34077	AL-MM-WW-MPR-S-PT	34207	ALD-SH-WW-MPR-B-PT	34323	ALD-MM-WW-MPR-B-PT	35615	ALD-MS-WW-MPR-W-PT
33964	AL-SL-NW-MPR-S-PT	34116	AL-LL-NW-MAT-W-PT	34212	ALD-SL-NW-MAT-S-PT	34326	ALD-MM-NW-MAT-S-PT	35628	ALD-MS-NW-MAT-B-PT
33965	AL-SH-NW-MPR-S-PT	34117	AL-LH-NW-MAT-W-PT	34213	ALD-SH-NW-MAT-S-PT	34327	ALD-MM-WW-MAT-S-PT	35632	ALD-MS-NW-MAT-S-PT
33966	AL-SL-WW-MPR-S-PT	34118	AL-LL-WW-MAT-W-PT	34214	ALD-SL-WW-MAT-S-PT	34328	ALD-MM-NW-MPR-S-PT	35624	ALD-MS-NW-MAT-W-PT
33967	AL-SH-WW-MPR-S-PT	34119	AL-LH-WW-MAT-W-PT	34215	ALD-SH-WW-MAT-S-PT	34329	ALD-MM-WW-MPR-S-PT	35630	ALD-MS-NW-MPR-B-PT
34008	AL-ML-NW-MAT-W-PT	34120	AL-LL-NW-MPR-W-PT	34216	ALD-SL-NW-MPR-S-PT	34368	ALD-LL-NW-MAT-W-PT	35634	ALD-MS-NW-MPR-S-PT
34009	AL-MH-NW-MAT-W-PT	34121	AL-LH-NW-MPR-W-PT	34217	ALD-SH-NW-MPR-S-PT	34369	ALD-LH-NW-MAT-W-PT	35626	ALD-MS-NW-MPR-W-PT
34010	AL-ML-WW-MAT-W-PT	34122	AL-LL-WW-MPR-W-PT	34218	ALD-SL-WW-MPR-S-PT	34370	ALD-LL-WW-MAT-W-PT	35629	ALD-MS-WW-MAT-B-PT
34011	AL-MH-WW-MAT-W-PT	34123	AL-LH-WW-MPR-W-PT	34219	ALD-SH-WW-MPR-S-PT	34371	ALD-LH-WW-MAT-W-PT	35633	ALD-MS-WW-MAT-S-PT
34012	AL-ML-NW-MPR-W-PT	34128	AL-LL-NW-MAT-B-PT	34260	ALD-ML-NW-MAT-W-PT	34372	ALD-LL-NW-MPR-W-PT	35625	ALD-MS-WW-MAT-W-PT
34013	AL-MH-NW-MPR-W-PT	34129	AL-LH-NW-MAT-B-PT	34261	ALD-MH-NW-MAT-W-PT	34373	ALD-LH-NW-MPR-W-PT	35631	ALD-MS-WW-MPR-B-PT
34014	AL-ML-WW-MPR-W-PT	34130	AL-LL-WW-MAT-B-PT	34262	ALD-ML-WW-MAT-W-PT	34374	ALD-LL-WW-MPR-W-PT	35635	ALD-MS-WW-MPR-S-PT
34015	AL-MH-WW-MPR-W-PT	34131	AL-LH-WW-MAT-B-PT	34263	ALD-MH-WW-MAT-W-PT	34375	ALD-LH-WW-MPR-W-PT	35627	ALD-MS-WW-MPR-W-PT

ALIN 4LED | ALIN 4LED LINE

T8 LED tube linear fitting

Adapted for use with T8 LED tubes, Kanlux ALIN 4LED is an ideal solution for anyone who values a replaceable light source. Thanks to branded components and top-of-the-line build quality, it is bound to offer excellent aesthetics and durability for many years. A wide range

of models makes it possible to find the perfect fitting for any investment project.

ALIN 4LED products are covered by a 5-year Warranty. For Warranty T&Cs, see the warranty statement at www.kanlux.com.

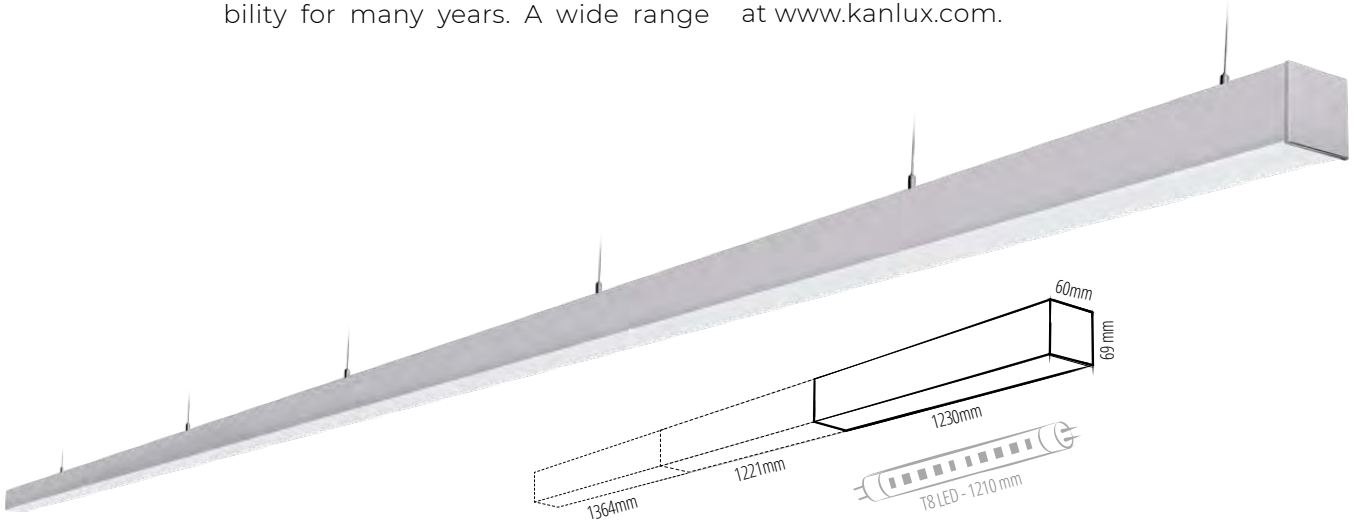

UNLIMITED LED LIGHT
LINE LENGTH



1230MM 4LED FITTINGS
CAN BE LINKED INTO LINES

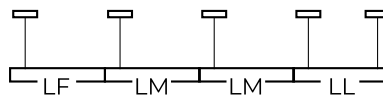

Kanlux
FACTORY

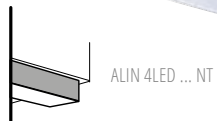
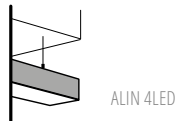

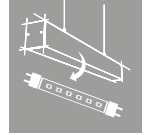

**We'll help you set up
your lighting the way
you want**

**CONFIGURE YOUR
PERFECT FITTING**

CONFIGURATOR



Use our configurator to create your perfect fitting, and we will manufacture it for you.

► KEY

AL 4LED	KANLUX ALIN 4LED
MAT	matte lampshade
MPR	microprismatic lampshade
W	housing: white
B	housing: black
S	housing colour: silver
NT	surface mounted version
ALIN NT +ALIN NT GRIP	wall mounted version
SE	motion detector version

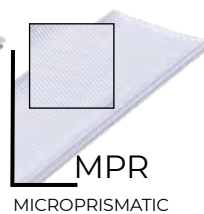
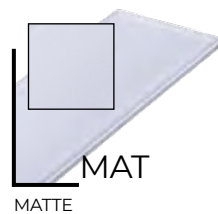

TWO DIFFUSER
VARIANTS



THREE HOUSING
COLOURS

WHAT MAKES US SPECIAL?

THREE FITTING LENGTHS

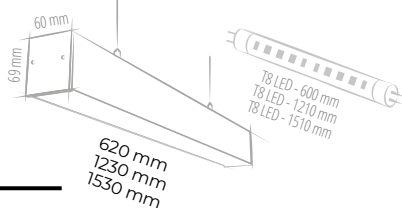

THREE
INSTALLATION
VARIANTS

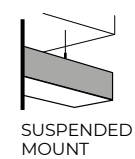
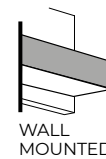
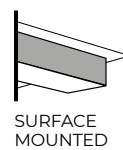

UNIQUE LIGHT LINE

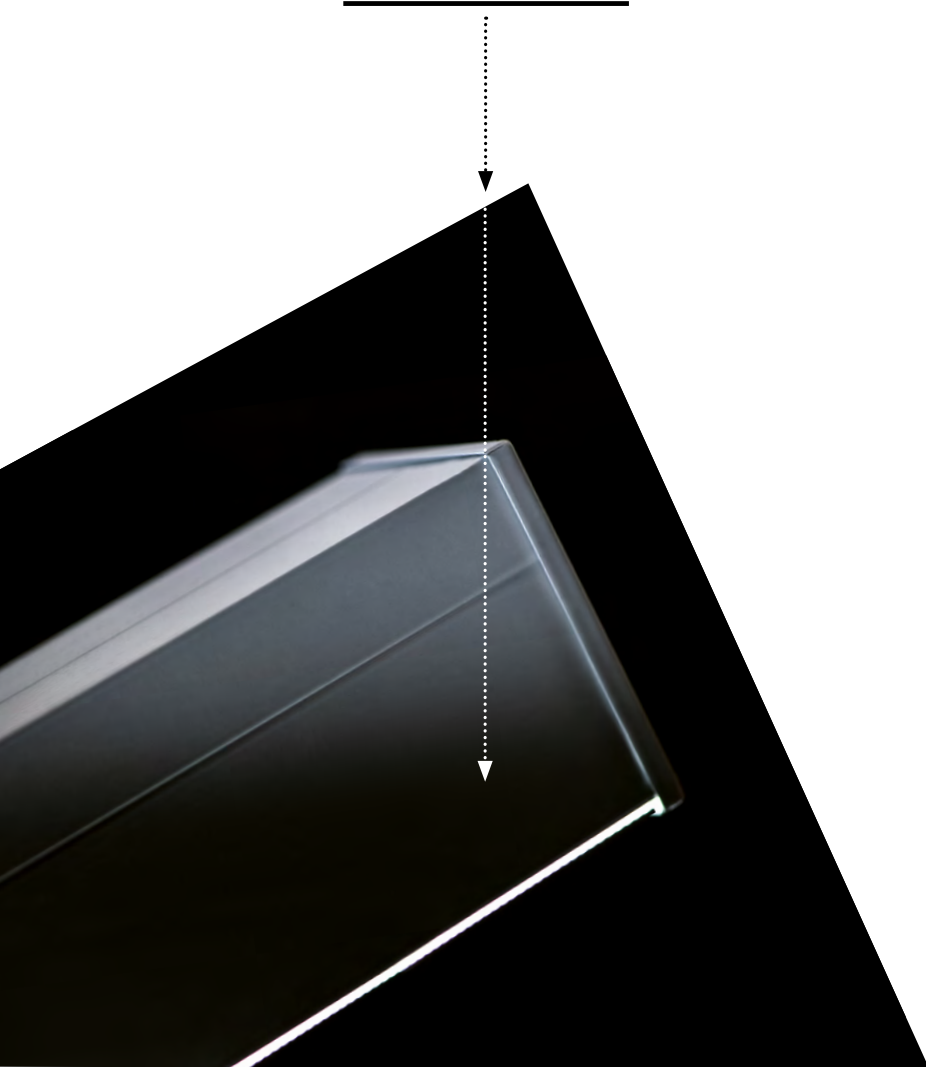

AL 4LED

28450	AL 4LED 120-MPR-B	28440	AL 4LED 60-MPR-W-NT
28447	AL 4LED 120-MPR-B-NT	27414	ALIN 4LED 1X120-B
28451	AL 4LED 120-MPR-SR	27420	ALIN 4LED 1X120-B-NT
28448	AL 4LED 120-MPR-SR-NT	27415	ALIN 4LED 1X120-SR
28449	AL 4LED 120-MPR-W	27421	ALIN 4LED 1X120-SR-NT
28446	AL 4LED 120-MPR-W-NT	27413	ALIN 4LED 1X120-W
28456	AL 4LED 150-MPR-B	27419	ALIN 4LED 1X120-W-NT
28453	AL 4LED 150-MPR-B-NT	27423	ALIN 4LED 1X150-B
28457	AL 4LED 150-MPR-SR	27426	ALIN 4LED 1X150-B-NT
28454	AL 4LED 150-MPR-SR-NT	27424	ALIN 4LED 1X150-SR
28455	AL 4LED 150-MPR-W	27427	ALIN 4LED 1X150-SR-NT
28452	AL 4LED 150-MPR-W-NT	27422	ALIN 4LED 1X150-W
28444	AL 4LED 60-MPR-B	27425	ALIN 4LED 1X150-W-NT
28441	AL 4LED 60-MPR-B-NT	27411	ALIN 4LED 1X60-B
28445	AL 4LED 60-MPR-SR	27417	ALIN 4LED 1X60-B-NT
28442	AL 4LED 60-MPR-SR-NT	27412	ALIN 4LED 1X60-SR
28443	AL 4LED 60-MPR-W	27418	ALIN 4LED 1X60-SR-NT
		27410	ALIN 4LED 1X60-W
		27416	ALIN 4LED 1X60-W-NT

ACCESSORIES

29557	ALIN-NT-GRIP
-------	--------------

OFIS

Office LED fitting

Kanlux OFIS S LED is a series of modern fittings designed primarily for office spaces. Featuring a simple and extremely sleek housing, the fitting is particularly stylish, blending seamlessly with the ceiling. The option to select housing and diffuser colours, as well as light colour temperatures, makes the luminaire extremely versatile,

while its unique design greatly expedites installation. Moreover, the product's new generation louvre reduces glare to a minimum.

OFIS S LED products are covered by a 5-year Warranty. For Warranty T&Cs, see the warranty statement at www.kanlux.com.



OFIS RST N3 B



OFIS RST N1 W



OFIS S P1 B



OFIS S P3 W

Kanlux
FACTORY

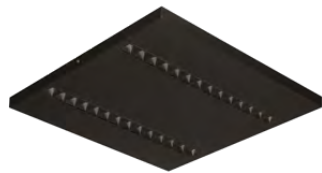

OFIS RST N1 B

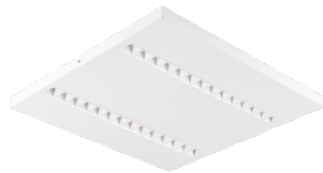

OFIS RST N1 W



OFIS S LED ... NT...N1

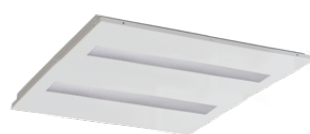

OFIS S LED ... PT...P1

► KEY LM

OS	OFIS S LED	
OSD	OFIS S LED DALI	
40W	power [W]	
S	ultra low power 22W	3000
L	low power 31W	4000
M	medium power 39W	5000
H	high power 49W	6000
5D	50-degree lens optics	
8D	80-degree lens optics	
WW/830	Ra≥80 3000K	
WN	Ra≥80 3500K	
NW/840	Ra≥80 4000K	
TW	TUNABLE WHITE design	
MPRM	microprismatic lampshade	
RST	louvre	
W	housing: white	
B	housing: black	
N1	600x600 surface mounted version	
N3	595x595 surface mounted version	
P1	595x595 recessed version	
P3	1195x295 recessed version	



We'll help you set up your lighting the way you want

CONFIGURE YOUR PERFECT FITTING

CONFIGURATOR



Use our configurator to create your perfect fitting, and we will manufacture it for you.

		600x600
S/W	3200 lm	UGR ≤ 14
S/B	2800 lm	UGR ≤ 14
L/W	4300 lm	UGR ≤ 15
L/B	3800 lm	UGR ≤ 15
M/W	5400 lm	UGR ≤ 16
M/B	4800 lm	UGR ≤ 16
H/W	6300 lm	UGR ≤ 16
H/B	5600 lm	UGR ≤ 16

DIMENSIONS

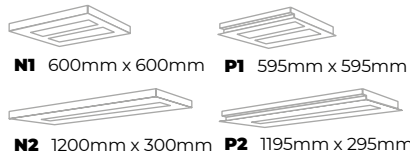

OPTIONAL DALI CONTROL

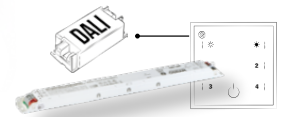

OSRAM LEDS AND POWER SUPPLIES



TWO VARIANTS

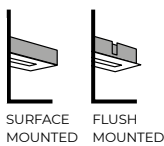

SURFACE MOUNTED FLUSH MOUNTED

TWO HOUSING COLOURS

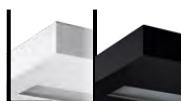

WHITE BLACK

THREE LIGHT COLOURS



WARM WHITE WARM NEUTRAL NEUTRAL

TWO VARIANTS OPTIC



50° LENS 80° LENS



MPR MICROPRISMATIC DIFFUSER



RST REDUCED GLARE THANKS TO A NEW GENERATION LOUVRE

OS MPR

35729	OS 40W-830-MPRM-B-N1	35732	OS 40W-830-MPRM-W-N1	32827	OS 40W-840-MPRM-B-P3	36392	OSD 40W-830-MPRM-B-P1	36399	OSD 40W-840-MPRM-B-N3
32819	OS 40W-830-MPRM-B-N3	35733	OS 40W-830-MPRM-W-N3	32820	OS 40W-840-MPRM-W-N1	36393	OSD 40W-830-MPRM-B-P3	36400	OSD 40W-840-MPRM-B-P1
35730	OS 40W-830-MPRM-B-P1	35734	OS 40W-830-MPRM-W-P1	32821	OS 40W-840-MPRM-W-N3	36394	OSD 40W-830-MPRM-W-N1	36401	OSD 40W-840-MPRM-B-P3
35731	OS 40W-830-MPRM-B-P3	35735	OS 40W-830-MPRM-W-P3	32822	OS 40W-840-MPRM-W-P1	36395	OSD 40W-830-MPRM-W-N3	36402	OSD 40W-840-MPRM-W-N1
		32824	OS 40W-840-MPRM-B-N1	32823	OS 40W-840-MPRM-W-P3	36396	OSD 40W-830-MPRM-W-P1	36403	OSD 40W-840-MPRM-W-N3
		32825	OS 40W-840-MPRM-B-N3	36390	OSD 40W-830-MPRM-B-N1	36397	OSD 40W-830-MPRM-W-P3	32828	OSD 40W-840-MPRM-W-P1
		32826	OS 40W-840-MPRM-B-P1	36391	OSD 40W-830-MPRM-B-N3	36398	OSD 40W-840-MPRM-B-N1	36404	OSD 40W-840-MPRM-W-P3

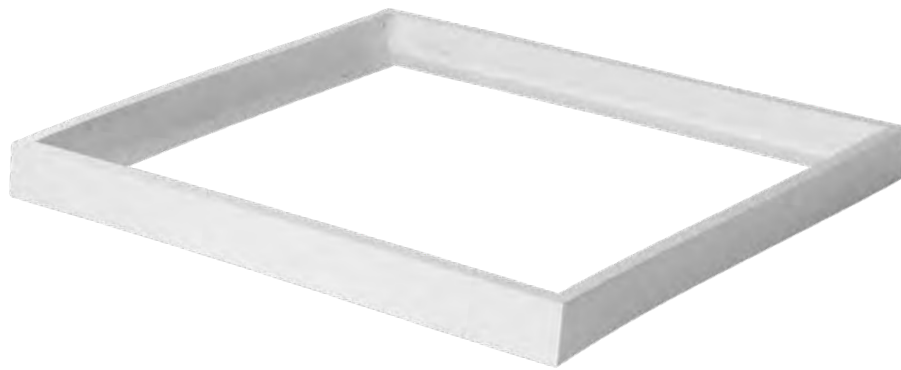

ADTR

Surface mounted frame

The ADTR family of universal adapters is the fastest way to surface-mount lighting panels like BRAVO or BLINGO. A monolithic design requiring no prior assembly saves time and en-

sure a perfect visual effect every time, under any conditions. The wide range of shapes and sizes ensures full compatibility with 99.9% of LED edge and backlight panel solutions on the market.

Kanlux
FACTORY



► KEY

ADTR	adapter
ADTR-H	high adapter
ADTR-H 76MM	high adapter 76mm
ADTR-S	adapter SLIM
ADTR-S-H	adapter SLIM high 76mm
W	housing colour: white
B	housing colour: black
S	housing colour: silver



THREE HEIGHTS



ADTR
height: 45mm



ADTR-H
height: 65mm



ADTR-H 76MM
height: 76mm

THREE SHAPES



ADTR 3060
300x600mm

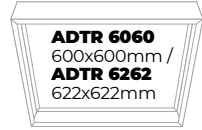

ADTR 6060
600x600mm /
ADTR 6262
622x622mm



ADTR 12030
300x1200mm

THREE HOUSING COLOURS



BLACK



WHITE



SILVER

EXCELLENT AESTHETICS

NO ADDITIONAL FASTENERS OR PLASTIC CORNER PIECES

HIGH RIGIDITY WITH CONSISTENT ANGLES

EXCELLENT AESTHETICS

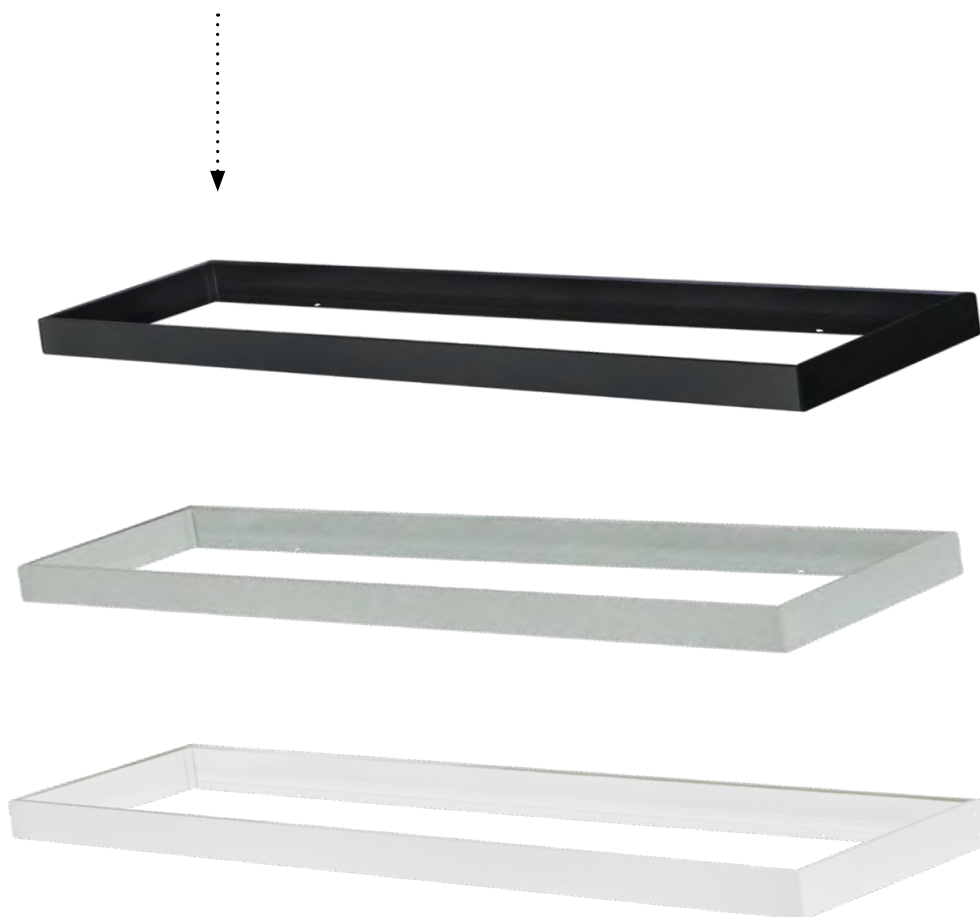

ADTR

27614	ADTR 12030 B	33431	ADTR 6262 SR
27612	ADTR 12030 SR	33432	ADTR 6262 W
27611	ADTR 12030 W	33391	ADTR-H 12030 B
29842	ADTR 3060 B	33392	ADTR-H 12030 SR
29841	ADTR 3060 SR	33390	ADTR-H 12030 W
29840	ADTR 3060 W	29845	ADTR-H 6060 B
33394	ADTR-H 3060 B	29844	ADTR-H 6060 SR
33395	ADTR-H 3060 SR	29843	ADTR-H 6060 W
33393	ADTR-H 3060 W	33433	ADTR-H 6262 B
27615	ADTR 6060 B	33434	ADTR-H 6262 SR
27610	ADTR 6060 SR	33435	ADTR-H 6262 W
27613	ADTR 6060 W	33398	ADTR-H 76MM 6060 W
33430	ADTR 6262 B	33437	ADTR-H 76MM 6262 B
		33438	ADTR-H 76MM 6262 SR
		33436	ADTR-H 76MM 6262 W
		27616	ADTR-S 6060 W
		27617	ADTR-S-H 6060 W



FUTURIO Dustproof LED fitting

Kanlux FUTURIO LED is a series of hermetic fittings manufactured at the Kanlux factory. Distinguished by high-quality workmanship and impressive parameters, they are also quick and easy to install. A broad selection of models makes it possible to find the perfect fitting for any investment project.

Specialised versions for high-temperature environments and with high luminous flux are also available.

FUTURIO LED products are covered by a 5-year Warranty. For Warranty T&Cs, see the warranty statement at www.kanlux.com.

► KEY

FT	FUTURIO LED
FTD	FUTURIO LED DALI
26W - 73W	power [W]
840	Ra>80 4000K
OPL	opal lampshade
RYF	prismatic structure lampshade
INT	narrow beam angle lens
ASY	asymmetrical beam angle lens
FTHL	special high-lumen version
SCF	simplified corridor function



CONFIGURATOR



**We'll help you set up
your lighting the way
you want**

**CONFIGURE YOUR
PERFECT FITTING**

Use our configurator to create your perfect fitting, and we will manufacture it for you.

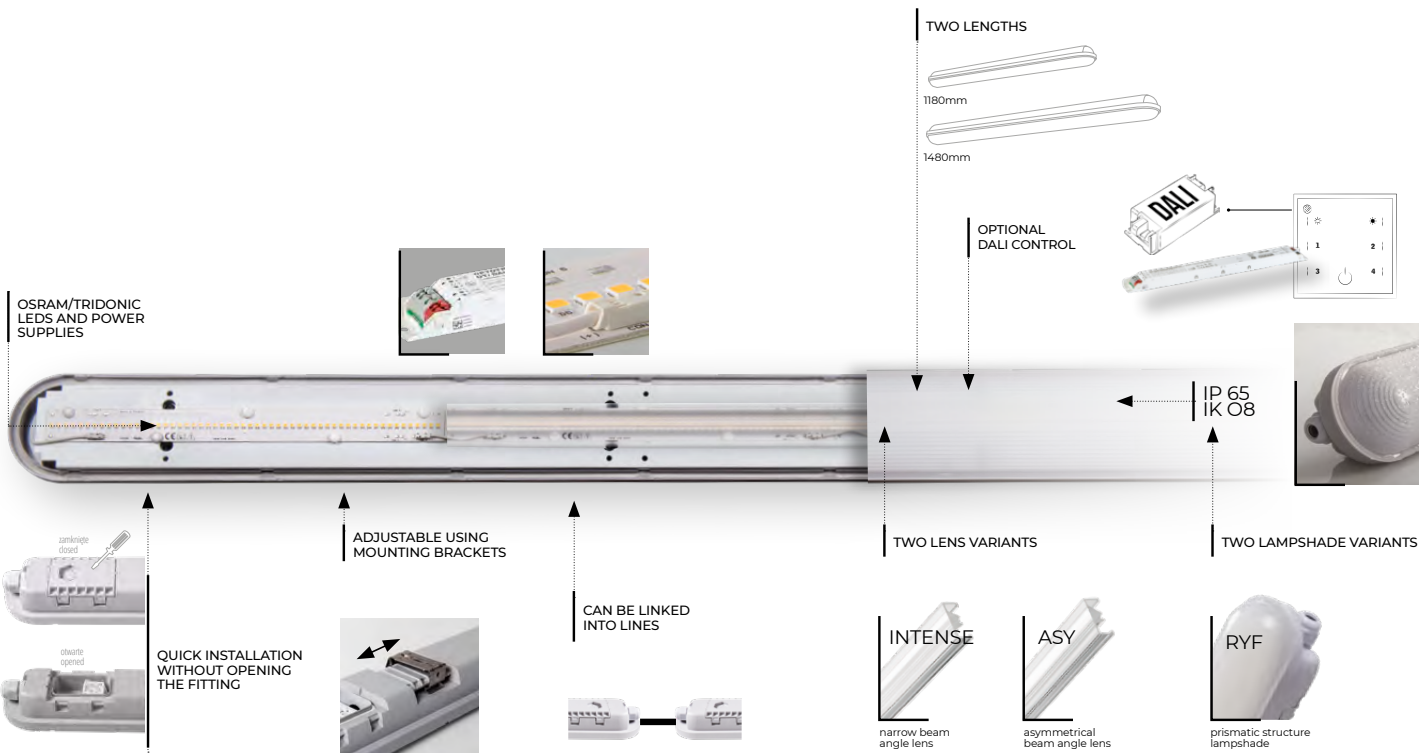

FT

28687	FT1200 26W-840-RYF	28631	FT1200 37W-840-RYF	28637	FTD1200 37W-840-OPL	28861	FT1500 43W-840-ASY	28666	FTD1500 55W-840-RYF
28850	FT1200 28W-840-OPL	28633	FT1200 37W-840-INT	28638	FTD1200 37W-840-RYF	28665	FT1500 55W-840-OPL	28668	FTD1500 55W-840-INT
28851	FT1200 28W-840-RYF	28634	FT1200 37W-840-ASY	28640	FTD1200 37W-840-INT	28659	FT1500 55W-840-RYF	28669	FTD1500 55W-840-ASY
28852	FT1200 28W-840-INT	28644	FT1200 49W-840-OPL	28641	FTD1200 37W-840-ASY	28661	FT1500 55W-840-INT	28870	FHT1500 43W-840-OPL
28853	FT1200 28W-840-ASY	28645	FT1200 49W-840-RYF	28651	FTD1200 49W-840-OPL	28662	FT1500 55W-840-ASY	28871	FHT1500 43W-840-RYF
28630	FT1200 37W-840-OPL	28647	FT1200 49W-840-INT	28652	FTD1200 49W-840-RYF	28686	FT1500 66W-840-RYF	28872	FHT1500 43W-840-INT
		28648	FT1200 49W-840-ASY	28654	FTD1200 49W-840-INT	28862	FTD1500 43W-840-OPL	28873	FHT1500 43W-840-ASY
		28854	FTD1200 28W-840-OPL	28655	FTD1200 49W-840-ASY	28863	FTD1500 43W-840-RYF	28866	FTHL1500 73W-840-OPL
		28855	FTD1200 28W-840-RYF	28858	FT1500 43W-840-OPL	28864	FTD1500 43W-840-INT	28867	FTHL1500 73W-840-RYF
		28856	FTD1200 28W-840-INT	28859	FT1500 43W-840-RYF	28865	FTD1500 43W-840-ASY	28868	FTHL1500 73W-840-INT
		28857	FTD1200 28W-840-ASY	28860	FT1500 43W-840-INT	28658	FTD1500 55W-840-OPL	28869	FTHL1500 73W-840-ASY

Kanlux
F△**ACTORY**
CONFIGURATOR

Kanlux FACTORY

Let's light up your
workspace

We'll help you set up your lighting the way you want

CONFIGURE YOUR PERFECT FITTING

LENGTH

LAMPSHADE

COLOUR TEMPERATURE

POWER

COLOUR

INSTALLATION METHOD

Use our configurator to create your perfect fitting, and we will manufacture it for you.



Kanlux **ALIN**



Kanlux **FUTURIO**

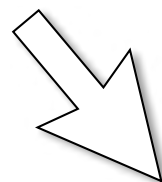

CONFIGURATOR



KANLUX SA

ul. Objazdowa 1 - 3, 41 - 922 Radzionków
POLSKA
tel. +48 32/388 74 00
fax +48 32/388 74 99
e-mail: kanlux@kanlux.pl

KANLUX LTD

2703 Sugar Mill Business Park,
Oakhurst Road, LS11 7HL Leeds
UNITED KINGDOM
salesuk@kanlux.com
tel.: +44 (0) 7725249456

KANLUX S.R.O.

Sadová 618, 738 01 Frýdek-Místek
ČESKÁ REPUBLIKA
tel. +420 558 402 511, 603 504 218
fax +420 558 694 250
e-mail: kanlux.cz@kanlux.cz

KANLUX S.R.O.

Zlatovská 2179/28, 911 05 Trenčín
SLOVENSKÁ REPUBLIKA
tel. +421 327 446 385-6
fax +421 327 446 387
e-mail: kanlux.sk@kanlux.sk

KANLUX KFT.

9026 Győr, Bácsai út 153/b
HUNGARY
tel. +36 96 525-467
fax +36 96 319-420
e-mail: info@kanlux.hu

ТОВ КАНЛЮКС

08130, Київська область,
Києво-Святошинський район,
с.Петропавлівська Борщагівка, вул. Соборна,
будинок 1-Б, офіс 617 УКРАЇНА
тел. +38 (044) 585 33 19
факс +38 (44) 585 33 18
e-mail: kanlux_ua@kanlux.com

KANLUX LITHUANIA and LATVIA DISTRIBUTION

tel. +37 065 693 649
e-mail: donatas.pliura@kanlux.com

KANLUX EOOD

Warehouse area Gopet Logistics, 1532 Kazichene,
Sofia, BULGARIA
tel. +359 2 421 96 24
fax +359 2 421 96 23
e-mail: kanlux.bg@kanlux.com

KANLUX GMBH

Flugplatz 21, 44319 Dortmund
DEUTSCHLAND
Tel. +49 231 56557255
Fax +49 231 56557256
e-mail: kanlux.gmbh@kanlux.com

KANLUX LIGHTING SRL

Kanlux Lighting S.R.L.Oltenitei 249
Popesti Leordeni, 077160, Ilfov,
ROMANIA
tel. +40 371 474 133
e-mail: comenzi@kanlux.com

KANLUX FRANCE SAS

224 bis, rue Marcadet,
75018 Paris
FRANCE
tel. +33 (0) 9 86 23 98 61
e-mail: kanlux.fr@kanlux.com

KANLUX ITALY DISTRIBUTION

mob. +39 (0) 339 833 78 00
e-mail: kanlux.it@kanlux.com

more than
more than light.
light.

