

## FL SOLNAR SLR

Соларно LED осветително тяло

IP  
54

EASY  
Installation

[V] 3,7 DC	15000	(h) 20000	Ellipse ≤ 6x MacAdam	Ra 80	SMD	
		(°C) -15÷35		[m] max 10	[°] 120	[s] - [min] 10-1
[lx] 15-1000	[W] max 100					

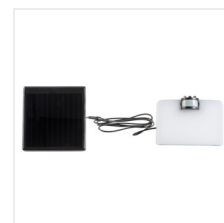
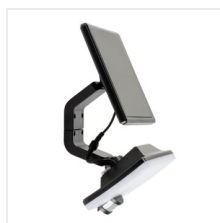

FL SOLNAR SLR 8W NW-B



IP



FL SOLNAR SLR 8W NW-B **36605** max 8 max 800 4000 54 PIR

- Материал на корпуса: PC
- Материал на дифузера: PC

## FL SOLNAR SLR

Соларно LED осветително тяло





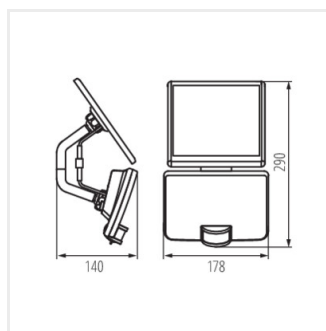

FL SOLNAR SLR 8W NW-B

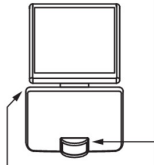

FL SOLNAR SLR 8W NW-B

## FL SOLNAR SLR

Соларно LED осветително тяло

	 15lx - 1000lx	
 <b>1 MODE</b>	—	max 800 lm ⌚ 10s - 60s
 <b>2 MODE</b> Night light	~40 lm	max 800 lm ⌚ 10s - 60s