

HIERRO

линейно LED осветително тяло









 [V] 220-240 AC	 [Hz] 50	 ≥ 30000	 [h] 50000	 ellipse $\leq 6x$ MacAdam	 Ra 80	 SMD
		 IP 20		 [°C] 5÷25		
 [mm ²] 1,5÷2,5		 0,5m				



HR-LL-WW-W-NT

HIERRO

линейно LED осветително тяло

								
		[W]	Tc [K]	TYPE	[°]		[lm]	[mm]
HR-LL-WW-W-NT	36945	23	3000	растер	X60/Y60	бял	3000	850
HR-LM-WW-W-NT	36946	32	3000	растер	X60/Y60	бял	4000	850
HR-LH-WW-W-NT	36947	42	3000	растер	X60/Y60	бял	4950	850
HR-LL-WW-B-NT	36953	23	3000	растер	X60/Y60	черен	2650	850
HR-LM-WW-B-NT	36954	32	3000	растер	X60/Y60	черен	3550	850
HR-LH-WW-B-NT	36955	42	3000	растер	X60/Y60	черен	4350	850
HR-LL-WN-W-NT	36961	23	3500	растер	X60/Y60	бял	3050	850
HR-LM-WN-W-NT	36962	32	3500	растер	X60/Y60	бял	4100	850
HR-LH-WN-W-NT	36963	42	3500	растер	X60/Y60	бял	5050	850
HR-LL-WN-B-NT	36969	23	3500	растер	X60/Y60	черен	2700	850
HR-LM-WN-B-NT	36970	32	3500	растер	X60/Y60	черен	3650	850
HR-LH-WN-B-NT	36971	42	3500	растер	X60/Y60	черен	4500	850
HR-LL-NW-W-NT	36977	23	4000	растер	X60/Y60	бял	3150	850
HR-LM-NW-W-NT	36978	32	4000	растер	X60/Y60	бял	4200	850
HR-LH-NW-W-NT	36979	42	4000	растер	X60/Y60	бял	5150	850
HR-LL-NW-B-NT	36985	23	4000	растер	X60/Y60	черен	2800	850
HR-LM-NW-B-NT	36986	32	4000	растер	X60/Y60	черен	3750	850
HR-LH-NW-B-NT	36987	42	4000	растер	X60/Y60	черен	4600	850

- Материал на корпуса: стомана, пластмаса
- Материал на дифузера: пластмаса



HIERRO

линейно LED осветително тяло



HR-LL-WW-W-NT



HR-LM-WW-W-NT



HR-LH-WW-W-NT



HR-LL-WW-B-NT



HR-LM-WW-B-NT



HR-LH-WW-B-NT



HR-LL-WN-W-NT



HR-LM-WN-W-NT



HR-LH-WN-W-NT



HR-LL-WN-B-NT



HR-LM-WN-B-NT



HR-LH-WN-B-NT



HR-LL-NW-W-NT



HR-LM-NW-W-NT



HR-LH-NW-W-NT



HR-LL-NW-B-NT

HIERRO

линейно LED осветително тяло



HR-LM-NW-B-NT



HR-LH-NW-B-NT

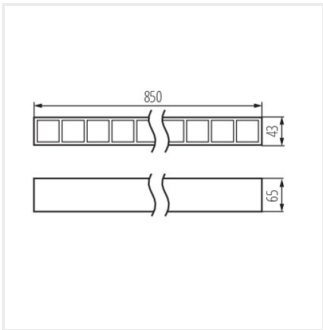

HR-LH-NT

