

KCP

Výkonový stykač KCP



U _{imp} [V] 6000	U _i [V] 690		IP 20	 TH 35	CE	EAC
UK CA						



KCP-09-230

	Kategorie použití	Napájecí napětí cívky [V]	Hlavní kontakty	Pomocné kontakty	Počet spínacích/rozpínacích	
KCP-09-230	24100	AC-3	230 AC	3	1	
KCP-09-24	24101	AC-3	24 AC	3	1	
KCP-12-230	24102	AC-3	230 AC	3	1	
KCP-12-24	24103	AC-3	24 AC	3	1	
KCP-18-230	24104	AC-3	230 AC	3	1	
KCP-18-24	24105	AC-3	24 AC	3	1	
KCP-25-230	24106	AC-3	230 AC	3	1	
KCP-25-24	24107	AC-3	24 AC	3	1	
KCP-32-230	24108	AC-3	230 AC	3	1	
KCP-32-24	24109	AC-3	24 AC	3	1	
KCP-AX11	24110	AC-15			2	1/1
KCP-AX22	24111	AC-15			4	2/2

KCP

Výkonový stykač KCP



KCP-09-230



KCP-09-24



KCP-12-230



KCP-12-24



KCP-18-230



KCP-18-24



KCP-25-230



KCP-25-24



KCP-32-230



KCP-32-24



KCP-AX11



KCP-AX22

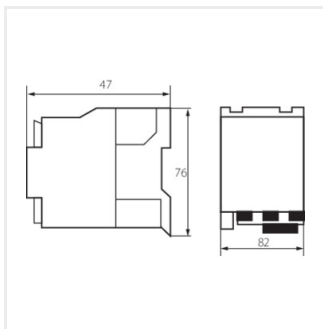

KCP-09-230

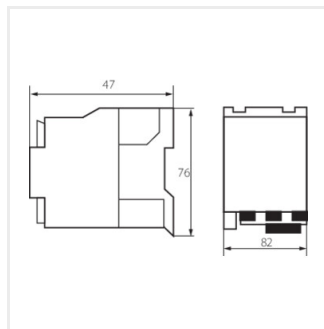

KCP-09-24

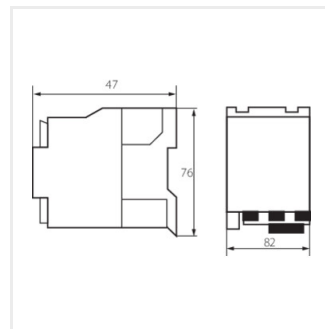

KCP-12-230

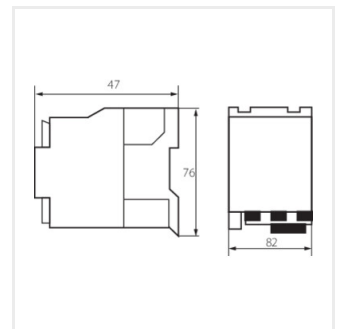

KCP-12-24

KCP

Výkonový stykač KCP

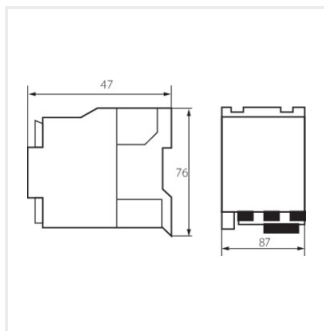

KCP-18-230

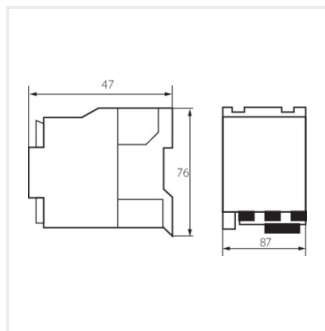

KCP-18-24

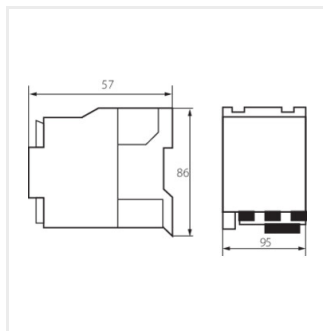

KCP-25-230

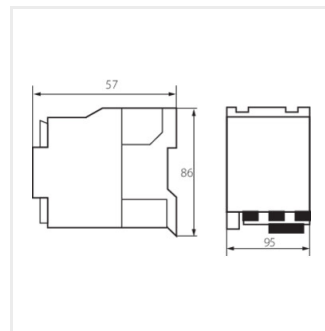

KCP-25-24

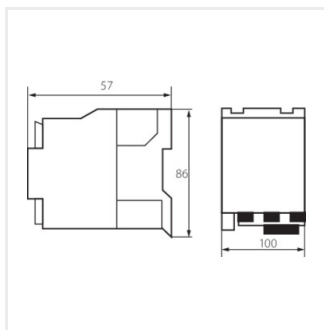

KCP-32-230

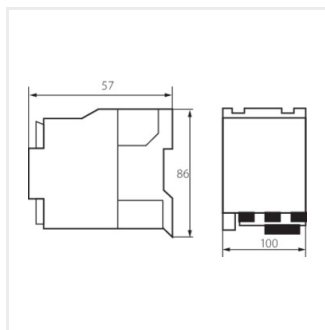

KCP-32-24

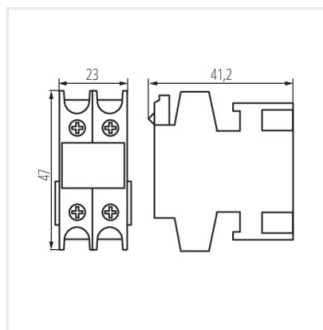

KCP-AX11

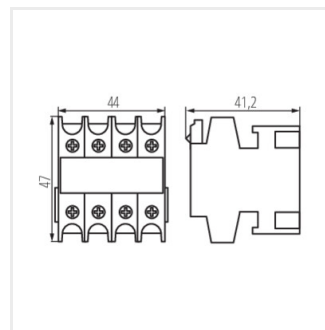

KCP-AX22