

BISO LED

Fasádní svítidlo

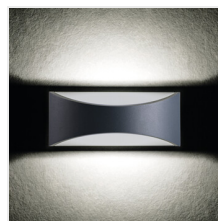

[V] 220-240 AC	[Hz] 50	≥25000	25000 [h]	ellipse ≤ 6x Mackdam	Ra 80	COB
		IP 54	0,5m		°C -15÷40	
 1,5÷2,5 [mm ²]	CE	EAC	UK CA			

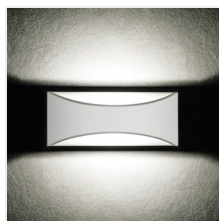

BISO LED EL 8W-GR



	[W]	[lm]	T _c [K]		
BISO LED EL 8W-GR	29260	8	140	4000	k usazení na zeď grafit
BISO LED EL 8W-W	29261	8	375	4000	k usazení na zeď bílá

Kanlux BISO jsou fasádní svítidla, která se vyznačují jednoduchým a atraktivním designem. Mohou být použita jako vnitřní svítidla (mají odpovídající CRI), zároveň mohou být použita na fasádách budov (IP54). Ve svítidle Kanlux BISO je dopadající světlo z LED modulu jemně rozptýleno na fasádě a na zadní straně svítidla.

- Materiál korpusu: hliníková slitina
- Materiál ochranného skla: plast

BISO LED

Fasádní svítidlo



BISO LED EL 8W-GR



BISO LED EL 8W-W

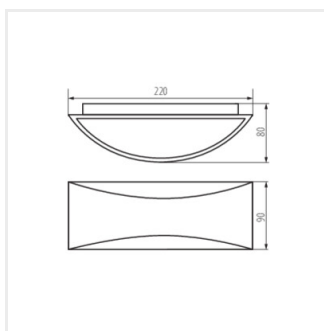

BISO LED EL 8W