

MERGE JQ

Pohybové čidlo PIR



MERGE JQ-L



MERGE JQ-L	07690	1200	k zabudování do zdi	H150/V60	10-7	PIR
MERGE JQ-O	07691	2000	k zabudování do stropu	H360/V120	5-6	PIR

Kanlux MERGE JQ je pohybové čidlo s maximálním detekčním dosahem 5 metrů. Vodorovný úhel senzoru je 150 stupňů. Můžeme nastavit dobu svícení a úroveň intenzity světla, při které senzor pracuje.



MERGE JQ-L



MERGE JQ-O

MERGE JQ

Pohybové čidlo PIR

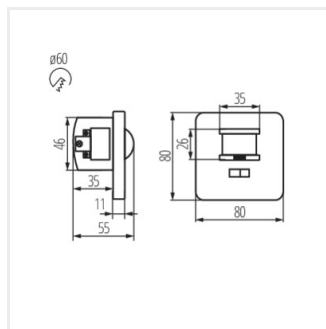

MERGE JQ-L

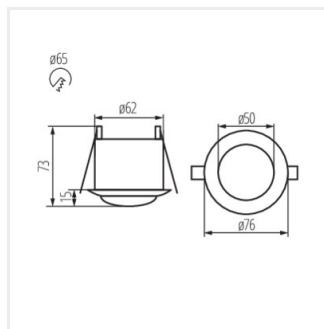

MERGE JQ-O