

HIERRO

LED-Longfieldleuchte









 [V] 220-240 AC	 [Hz] 50	 ≥ 30000	 [h] 50000	 ellipse $\leq 6x$ MacAdam	 Ra 80	 SMD
 DALI	 ⊕	 IP 20		 [°C] 5÷25		
 [mm²] 0,5÷2,5		 0,5m				



HRD-LL-WW-W-NT

HIERRO

LED-Langfeldleuchte

								
HRD-LL-WW-W-NT	36991	23	3000	raster	X60/Y60	weiß	3000	850
HRD-LM-WW-W-NT	36992	32	3000	raster	X60/Y60	weiß	4000	850
HRD-LH-WW-W-NT	36993	42	3000	raster	X60/Y60	weiß	4950	850
HRD-LL-WW-B-NT	36997	23	3000	raster	X60/Y60	schwarz	2650	850
HRD-LM-WW-B-NT	36998	32	3000	raster	X60/Y60	schwarz	3550	850
HRD-LH-WW-B-NT	36999	42	3000	raster	X60/Y60	schwarz	4350	850
HRD-LL-WN-W-NT	37003	23	3500	raster	X60/Y60	weiß	3050	850
HRD-LM-WN-W-NT	37004	32	3500	raster	X60/Y60	weiß	4100	850
HRD-LH-WN-W-NT	37005	42	3500	raster	X60/Y60	weiß	5050	850
HRD-LL-WN-B-NT	37009	23	3500	raster	X60/Y60	schwarz	2700	850
HRD-LM-WN-B-NT	37010	32	3500	raster	X60/Y60	schwarz	3650	850
HRD-LH-WN-B-NT	37011	42	3500	raster	X60/Y60	schwarz	4500	850
HRD-LL-NW-W-NT	37015	23	4000	raster	X60/Y60	weiß	3150	850
HRD-LM-NW-W-NT	37016	32	4000	raster	X60/Y60	weiß	4200	850
HRD-LH-NW-W-NT	37017	42	4000	raster	X60/Y60	weiß	5150	850
HRD-LL-NW-B-NT	37021	23	4000	raster	X60/Y60	schwarz	2800	850
HRD-LM-NW-B-NT	37022	32	4000	raster	X60/Y60	schwarz	3750	850
HRD-LH-NW-B-NT	37023	42	4000	raster	X60/Y60	schwarz	4600	850

- Gehäusematerial: Stahl, Kunststoff
- Abdeckungsmaterial: Kunststoff

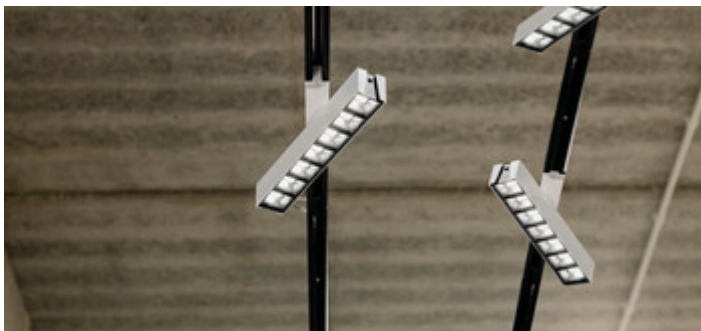

HIERRO

LED-Longfieldleuchte



HRD-LL-WW-W-NT



HRD-LM-WW-W-NT



HRD-LH-WW-W-NT



HRD-LL-WW-B-NT



HRD-LM-WW-B-NT



HRD-LH-WW-B-NT



HRD-LL-WN-W-NT



HRD-LM-WN-W-NT



HRD-LH-WN-W-NT



HRD-LL-WN-B-NT



HRD-LM-WN-B-NT



HRD-LH-WN-B-NT



HRD-LL-NW-W-NT



HRD-LM-NW-W-NT



HRD-LH-NW-W-NT



HRD-LL-NW-B-NT

HIERRO

LED-Longfieldleuchte



HRD-LM-NW-B-NT



HRD-LH-NW-B-NT

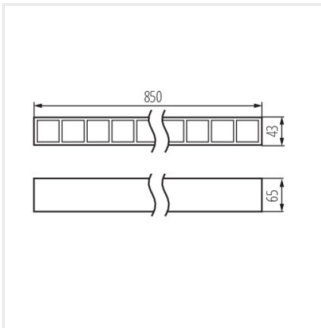

HRD-LH-NT

