

## HIERRO

Linear LED luminaire









[V] 220-240 AC	[Hz] 50	$\geq 30000$	[h] 50000	ellipse $\leq 6x$ MacAdam	Ra 80	SMD
DALI		IP 20		[°C] 5÷25		
[mm] 0.5÷2.5		m 0,5m	CE	EAC	UK CA	



HRD-LL-WW-W-NT

## HIERRO

### Linear LED luminaire

								
HRD-LL-WW-W-NT	<b>36991</b>	23	3000	louvre / white	X60/Y60	white	3000	850
HRD-LM-WW-W-NT	<b>36992</b>	32	3000	louvre / white	X60/Y60	white	4000	850
HRD-LH-WW-W-NT	<b>36993</b>	42	3000	louvre / white	X60/Y60	white	4950	850
HRD-LL-WW-B-NT	<b>36997</b>	23	3000	louvre / black	X60/Y60	black	2650	850
HRD-LM-WW-B-NT	<b>36998</b>	32	3000	louvre / black	X60/Y60	black	3550	850
HRD-LH-WW-B-NT	<b>36999</b>	42	3000	louvre / black	X60/Y60	black	4350	850
HRD-LL-WN-W-NT	<b>37003</b>	23	3500	louvre / white	X60/Y60	white	3050	850
HRD-LM-WN-W-NT	<b>37004</b>	32	3500	louvre / white	X60/Y60	white	4100	850
HRD-LH-WN-W-NT	<b>37005</b>	42	3500	louvre / white	X60/Y60	white	5050	850
HRD-LL-WN-B-NT	<b>37009</b>	23	3500	louvre / black	X60/Y60	black	2700	850
HRD-LM-WN-B-NT	<b>37010</b>	32	3500	louvre / black	X60/Y60	black	3650	850
HRD-LH-WN-B-NT	<b>37011</b>	42	3500	louvre / black	X60/Y60	black	4500	850
HRD-LL-NW-W-NT	<b>37015</b>	23	4000	louvre / white	X60/Y60	white	3150	850
HRD-LM-NW-W-NT	<b>37016</b>	32	4000	louvre / white	X60/Y60	white	4200	850
HRD-LH-NW-W-NT	<b>37017</b>	42	4000	louvre / white	X60/Y60	white	5150	850
HRD-LL-NW-B-NT	<b>37021</b>	23	4000	louvre / black	X60/Y60	black	2800	850
HRD-LM-NW-B-NT	<b>37022</b>	32	4000	louvre / black	X60/Y60	black	3750	850
HRD-LH-NW-B-NT	<b>37023</b>	42	4000	louvre / black	X60/Y60	black	4600	850

HIERRO is a family of fixtures produced at the Kanlux Factory. The minimalist and elegant form fits into the latest trends in architectural design. The stylish solution is widely used in modern offices, shops, and loft spaces as basic, complementary or accent lighting. The great advantages of HIERRO luminaires are: variety of available control and installation methods, low UGR coefficient, high luminous efficiency, ability to adapt to specific lighting projects and 5-year warranty. This allows you to create energy-saving and modern lighting systems that provide attractive lighting effects.

- Enclosure material: steel, plastic
- Lampshade material: plastic



## HIERRO

### Linear LED luminaire



HRD-LL-WW-W-NT



HRD-LM-WW-W-NT



HRD-LH-WW-W-NT



HRD-LL-WW-B-NT



HRD-LM-WW-B-NT



HRD-LH-WW-B-NT



HRD-LL-WN-W-NT



HRD-LM-WN-W-NT



HRD-LH-WN-W-NT



HRD-LL-WN-B-NT



HRD-LM-WN-B-NT



HRD-LH-WN-B-NT



HRD-LL-NW-W-NT



HRD-LM-NW-W-NT



HRD-LH-NW-W-NT



HRD-LL-NW-B-NT

## HIERRO

---

### Linear LED luminaire



HRD-LM-NW-B-NT



HRD-LH-NW-B-NT

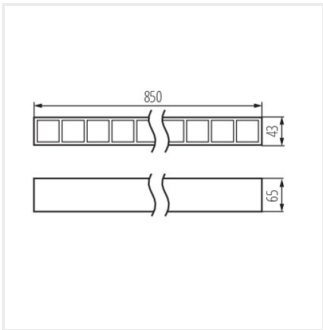

HRD-LH-NT

