













SQMOTION

Détecteur de mouvement HF

 [V] 220-240 AC	 [Hz] 50	IP 20			 [m] max 8	 [lx] 3-2000
 [°C] 5÷25		 [mm] 0,75÷1,5				



SQMOTION-W



SQMOTION-W	37360	800	saillie, mural	360	10-12	Hyperfréquence
SQMOTION-B	37361	800	saillie, mural	360	10-12	Hyperfréquence

- Matériau: matériau plastique



SQMOTION-W



SQMOTION-B

SQMOTION

Détecteur de mouvement HF

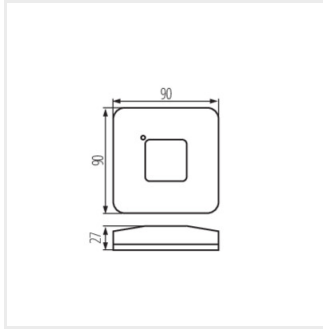

SQMOTION-W

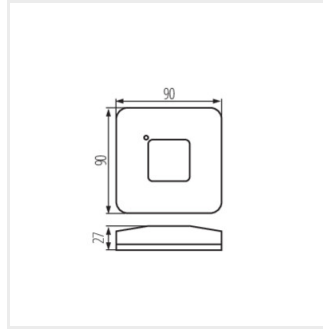

SQMOTION-B