

HIERRO

Plafoniera LED lineare









 220-240 AC	 50	 ≥30000	 50000	 Ra 80	
		 IP 20		 5÷25	
 1,5÷2,5		 0,5m			



HR-LL-WW-W-NT

HIERRO

Plafoniera LED lineare

				TYPE				
		[W]	Tc [K]		[°]		[m]	[mm]
HR-LL-WW-W-NT	36945	23	3000	raster	X60/Y60	bianco	3000	850
HR-LM-WW-W-NT	36946	32	3000	raster	X60/Y60	bianco	4000	850
HR-LH-WW-W-NT	36947	42	3000	raster	X60/Y60	bianco	4950	850
HR-LL-WW-B-NT	36953	23	3000	raster	X60/Y60	nero	2650	850
HR-LM-WW-B-NT	36954	32	3000	raster	X60/Y60	nero	3550	850
HR-LH-WW-B-NT	36955	42	3000	raster	X60/Y60	nero	4350	850
HR-LL-WN-W-NT	36961	23	3500	raster	X60/Y60	bianco	3050	850
HR-LM-WN-W-NT	36962	32	3500	raster	X60/Y60	bianco	4100	850
HR-LH-WN-W-NT	36963	42	3500	raster	X60/Y60	bianco	5050	850
HR-LL-WN-B-NT	36969	23	3500	raster	X60/Y60	nero	2700	850
HR-LM-WN-B-NT	36970	32	3500	raster	X60/Y60	nero	3650	850
HR-LH-WN-B-NT	36971	42	3500	raster	X60/Y60	nero	4500	850
HR-LL-NW-W-NT	36977	23	4000	raster	X60/Y60	bianco	3150	850
HR-LM-NW-W-NT	36978	32	4000	raster	X60/Y60	bianco	4200	850
HR-LH-NW-W-NT	36979	42	4000	raster	X60/Y60	bianco	5150	850
HR-LL-NW-B-NT	36985	23	4000	raster	X60/Y60	nero	2800	850
HR-LM-NW-B-NT	36986	32	4000	raster	X60/Y60	nero	3750	850
HR-LH-NW-B-NT	36987	42	4000	raster	X60/Y60	nero	4600	850

- Materiale del corpo: metallo, plastica
- Diffusore: plastica

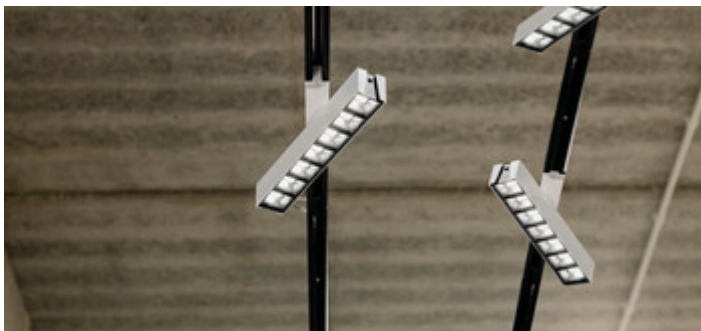

HIERRO

Plafoniera LED lineare



HR-LL-WW-W-NT



HR-LM-WW-W-NT



HR-LH-WW-W-NT



HR-LL-WW-B-NT



HR-LM-WW-B-NT



HR-LH-WW-B-NT



HR-LL-WN-W-NT



HR-LM-WN-W-NT



HR-LH-WN-W-NT



HR-LL-WN-B-NT



HR-LM-WN-B-NT



HR-LH-WN-B-NT



HR-LL-NW-W-NT



HR-LM-NW-W-NT



HR-LH-NW-W-NT



HR-LL-NW-B-NT

HIERRO

Plafoniera LED lineare



HR-LM-NW-B-NT



HR-LH-NW-B-NT

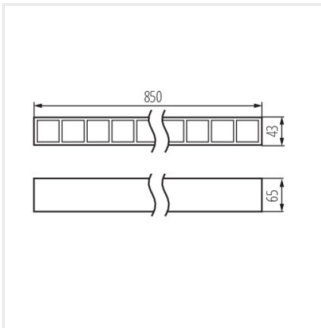

HR-LH-NT

