

HIERRO

Plafoniera LED lineare









 [V] 220-240 AC	 [Hz] 50	 ≥ 30000	 [h] 50000	 ellipse $\leq 6^\circ$ MacAdam	 Ra 80	 SMD
 DALI	 ⊕	 IP 20		 [°C] 5÷25		
 [mm] 0,5÷2,5		 0,5m				



HRD-LL-WW-W-NT

HIERRO

Plafoniera LED lineare

								
HRD-LL-WW-W-NT	36991	23	3000	raster	X60/Y60	bianco	3000	850
HRD-LM-WW-W-NT	36992	32	3000	raster	X60/Y60	bianco	4000	850
HRD-LH-WW-W-NT	36993	42	3000	raster	X60/Y60	bianco	4950	850
HRD-LL-WW-B-NT	36997	23	3000	raster	X60/Y60	nero	2650	850
HRD-LM-WW-B-NT	36998	32	3000	raster	X60/Y60	nero	3550	850
HRD-LH-WW-B-NT	36999	42	3000	raster	X60/Y60	nero	4350	850
HRD-LL-WN-W-NT	37003	23	3500	raster	X60/Y60	bianco	3050	850
HRD-LM-WN-W-NT	37004	32	3500	raster	X60/Y60	bianco	4100	850
HRD-LH-WN-W-NT	37005	42	3500	raster	X60/Y60	bianco	5050	850
HRD-LL-WN-B-NT	37009	23	3500	raster	X60/Y60	nero	2700	850
HRD-LM-WN-B-NT	37010	32	3500	raster	X60/Y60	nero	3650	850
HRD-LH-WN-B-NT	37011	42	3500	raster	X60/Y60	nero	4500	850
HRD-LL-NW-W-NT	37015	23	4000	raster	X60/Y60	bianco	3150	850
HRD-LM-NW-W-NT	37016	32	4000	raster	X60/Y60	bianco	4200	850
HRD-LH-NW-W-NT	37017	42	4000	raster	X60/Y60	bianco	5150	850
HRD-LL-NW-B-NT	37021	23	4000	raster	X60/Y60	nero	2800	850
HRD-LM-NW-B-NT	37022	32	4000	raster	X60/Y60	nero	3750	850
HRD-LH-NW-B-NT	37023	42	4000	raster	X60/Y60	nero	4600	850

- Materiale del corpo: metallo, plastica
- Diffusore: plastica

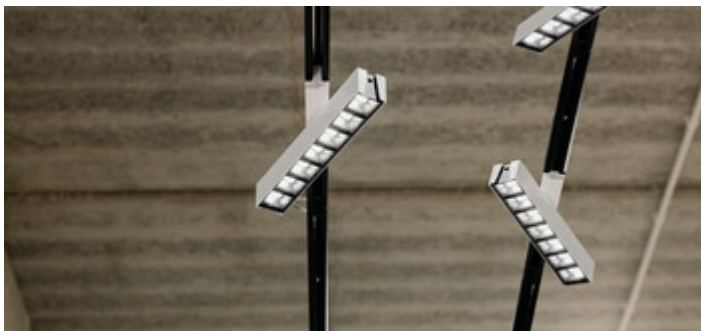

HIERRO

Plafoniera LED lineare



HRD-LL-WW-W-NT



HRD-LM-WW-W-NT



HRD-LH-WW-W-NT



HRD-LL-WW-B-NT



HRD-LM-WW-B-NT



HRD-LH-WW-B-NT



HRD-LL-WN-W-NT



HRD-LM-WN-W-NT



HRD-LH-WN-W-NT



HRD-LL-WN-B-NT



HRD-LM-WN-B-NT



HRD-LH-WN-B-NT



HRD-LL-NW-W-NT



HRD-LM-NW-W-NT



HRD-LH-NW-W-NT



HRD-LL-NW-B-NT

HIERRO

Plafoniera LED lineare



HRD-LM-NW-B-NT



HRD-LH-NW-B-NT

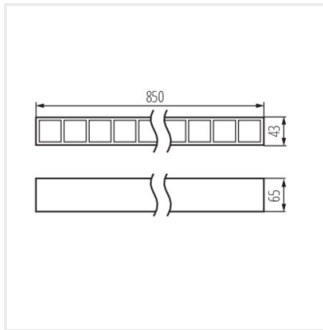

HRD-LH-NT

