













## LONVI

### Pierścień oprawy punktowej

unique  
**LIGHT**  
effect

HIGH  
quality  
finish

MO  
DE  
RN  
design

 12 AC; 12 DC; 220-240 AC		 max 10	 6x5,3/GU10			<b>IP</b> 20
	 5-25	 Ø80	 0,5m		 MR16/PAR16	<b>CE</b>
<b>UK</b> <b>CA</b>						



LONVI DSL W/W



LONVI DSL W/W **35740**

LONVI DSO W/W **35741**

Pierścień oprawy punktowej Kanlux LONVI dostępny jest w dwóch wersjach - okrągłej i kwadratowej. Akrylowy, świecący pierścień tej oprawy stanowi dodatkowy efekt dekoracyjny. Prosta, ale nie banalna stylistyka sprawia, że idealnie wpasujemy go w wiele typów wnętrz. Biały, neutralny kolor tego pierścienia daje nam jeszcze więcej możliwości w jego zastosowaniu. Równie dobrze sprawdzi się w sypialni jak i w salonie.

- Pierścień dekoracyjny bez oprawki ceramicznej
- Materiał obudowy: stop aluminium, tworzywo sztuczne

## LONVI

### Pierścień oprawy punktowej

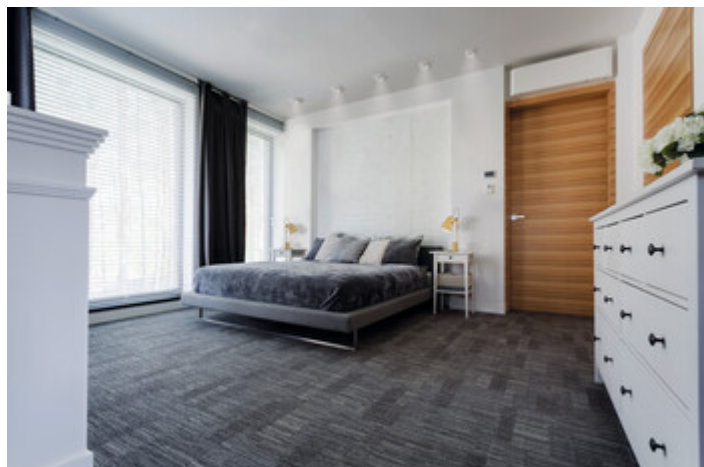

LONVI DSL W/W



LONVI DSO W/W

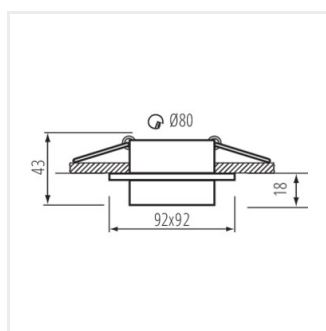

LONVI DSL W/W

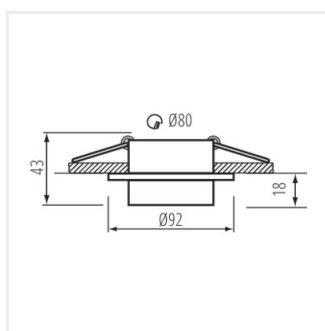

LONVI DSO W/W