

OFIS RST LED P1

Oprawa biurowa LED podtynkowa



 220-240 AC	 50	 ≥30000	 50000	 ≤3x MacAdam	 Ra 80	
		 IP 20		 5÷25		
 1,5÷2,5	 0,5m					



OS-H5D-NW-RST-B-P1







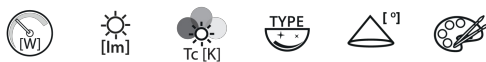

OS-H5D-NW-RST-B-P1	35968	49W	5600	4000	raster	50	czarny
OS-H5D-NW-RST-W-P1	35840	49W	6300	4000	raster	50	biały
OS-H5D-WN-RST-B-P1	36144	49W	5600	3500	raster	50	czarny
OS-H5D-WN-RST-W-P1	36080	49W	6300	3500	raster	50	biały
OS-H5D-WW-RST-B-P1	35952	49W	5600	3000	raster	50	czarny
OS-H5D-WW-RST-W-P1	35824	49W	6300	3000	raster	50	biały
OS-H8D-NW-RST-B-P1	36000	49W	5600	4000	raster	80	czarny
OS-H8D-NW-RST-W-P1	35872	49W	6300	4000	raster	80	biały
OS-H8D-WN-RST-B-P1	36160	49W	5600	3500	raster	80	czarny
OS-H8D-WN-RST-W-P1	36096	49W	6300	3500	raster	80	biały
OS-H8D-WW-RST-B-P1	35984	49W	5600	3000	raster	80	czarny
OS-H8D-WW-RST-W-P1	35856	49W	6300	3000	raster	80	biały
OS-L5D-NW-RST-B-P1	35960	31W	3800	4000	raster	50	czarny
OS-L5D-NW-RST-W-P1	35832	31W	4300	4000	raster	50	biały
OS-L5D-WN-RST-B-P1	36136	31W	3800	3500	raster	50	czarny
OS-L5D-WN-RST-W-P1	36072	31W	4300	3500	raster	50	biały

OFIS RST LED P1

Oprawa biurowa LED podtynkowa



							
OS-L5D-WW-RST-B-P1	35944	31W	3800	3000	raster	50	czarny
OS-L5D-WW-RST-W-P1	35816	31W	4300	3000	raster	50	biały
OS-L8D-NW-RST-B-P1	35992	31W	3800	4000	raster	80	czarny
OS-L8D-NW-RST-W-P1	35864	31W	4300	4000	raster	80	biały
OS-L8D-WN-RST-B-P1	36152	31W	3800	3500	raster	80	czarny
OS-L8D-WN-RST-W-P1	36088	31W	4300	3500	raster	80	biały
OS-L8D-WW-RST-B-P1	35976	31W	3800	3000	raster	80	czarny
OS-L8D-WW-RST-W-P1	35848	31W	4300	3000	raster	80	biały
OS-M5D-NW-RST-B-P1	35964	39W	4800	4000	raster	50	czarny
OS-M5D-NW-RST-W-P1	35836	39W	5400	4000	raster	50	biały
OS-M5D-WN-RST-B-P1	36140	39W	4800	3500	raster	50	czarny
OS-M5D-WN-RST-W-P1	36076	39W	5400	3500	raster	50	biały
OS-M5D-WW-RST-B-P1	35948	39W	4800	3000	raster	50	czarny
OS-M5D-WW-RST-W-P1	35820	39W	5400	3000	raster	50	biały
OS-M8D-NW-RST-B-P1	35996	39W	4800	4000	raster	80	czarny
OS-M8D-NW-RST-W-P1	35868	39W	5400	4000	raster	80	biały
OS-M8D-WN-RST-B-P1	36156	39W	4800	3500	raster	80	czarny
OS-M8D-WN-RST-W-P1	36092	39W	5400	3500	raster	80	biały
OS-M8D-WW-RST-B-P1	35980	39W	4800	3000	raster	80	czarny
OS-M8D-WW-RST-W-P1	35852	39W	5400	3000	raster	80	biały
OS-S5D-NW-RST-B-P1	35956	22W	2800	4000	raster	50	czarny
OS-S5D-NW-RST-W-P1	35828	22W	3200	4000	raster	50	biały
OS-S5D-WN-RST-B-P1	36132	22W	2800	3500	raster	50	czarny
OS-S5D-WN-RST-W-P1	36068	22W	3200	3500	raster	50	biały
OS-S5D-WW-RST-B-P1	35940	22W	2800	3000	raster	50	czarny
OS-S5D-WW-RST-W-P1	35812	22W	3200	3000	raster	50	biały
OS-S8D-NW-RST-B-P1	35988	22W	2800	4000	raster	80	czarny
OS-S8D-NW-RST-W-P1	35860	22W	3200	4000	raster	80	biały
OS-S8D-WN-RST-B-P1	36148	22W	2800	3500	raster	80	czarny
OS-S8D-WN-RST-W-P1	36084	22W	3200	3500	raster	80	biały
OS-S8D-WW-RST-B-P1	35972	22W	2800	3000	raster	80	czarny
OS-S8D-WW-RST-W-P1	35844	22W	3200	3000	raster	80	biały

Seria opraw dla profesjonalistów z Fabryki Kanlux, która łączy funkcjonalność i estetykę. Dzięki bardzo dobrym parametrom świetlnym oprawy OFIS RST LED pozwalają na tworzenie energooszczędnych i nowoczesnych systemów oświetleniowych. Pełnego obrazu produktu dopełnia niski współczynnik oślnienia UGR, który poprawia komfort pracy i efekty wizualne.

- 5 lat Gwarancji na warunkach oświadczenia gwarancyjnego, dostępnego na stronie internetowej
- Materiał obudowy: metal
- Materiał klosza: tworzywo sztuczne

OFIS RST LED P1

Oprawa biurowa LED podtynkowa



OS RST B P1



OS RST W P1

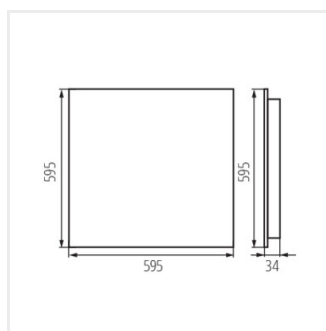

OS RST P1

