

## HIERRO

### Oprawa liniowa LED









 220-240 AC	 50	 ≥30000	 50000	 Ra 80	
		 IP 20		 5÷25	
 1,5÷2,5		 0,5m			



HR-LL-WW-W-NT

## HIERRO

### Oprawa liniowa LED

								
HR-LL-WW-W-NT	<b>36945</b>	23	3000	raster / biały	X60/Y60	biały	3000	850
HR-LM-WW-W-NT	<b>36946</b>	32	3000	raster / biały	X60/Y60	biały	4000	850
HR-LH-WW-W-NT	<b>36947</b>	42	3000	raster / biały	X60/Y60	biały	4950	850
HR-LL-WW-B-NT	<b>36953</b>	23	3000	raster / czarny	X60/Y60	czarny	2650	850
HR-LM-WW-B-NT	<b>36954</b>	32	3000	raster / czarny	X60/Y60	czarny	3550	850
HR-LH-WW-B-NT	<b>36955</b>	42	3000	raster / czarny	X60/Y60	czarny	4350	850
HR-LL-WN-W-NT	<b>36961</b>	23	3500	raster / biały	X60/Y60	biały	3050	850
HR-LM-WN-W-NT	<b>36962</b>	32	3500	raster / biały	X60/Y60	biały	4100	850
HR-LH-WN-W-NT	<b>36963</b>	42	3500	raster / biały	X60/Y60	biały	5050	850
HR-LL-WN-B-NT	<b>36969</b>	23	3500	raster / czarny	X60/Y60	czarny	2700	850
HR-LM-WN-B-NT	<b>36970</b>	32	3500	raster / czarny	X60/Y60	czarny	3650	850
HR-LH-WN-B-NT	<b>36971</b>	42	3500	raster / czarny	X60/Y60	czarny	4500	850
HR-LL-NW-W-NT	<b>36977</b>	23	4000	raster / biały	X60/Y60	biały	3150	850
HR-LM-NW-W-NT	<b>36978</b>	32	4000	raster / biały	X60/Y60	biały	4200	850
HR-LH-NW-W-NT	<b>36979</b>	42	4000	raster / biały	X60/Y60	biały	5150	850
HR-LL-NW-B-NT	<b>36985</b>	23	4000	raster / czarny	X60/Y60	czarny	2800	850
HR-LM-NW-B-NT	<b>36986</b>	32	4000	raster / czarny	X60/Y60	czarny	3750	850
HR-LH-NW-B-NT	<b>36987</b>	42	4000	raster / czarny	X60/Y60	czarny	4600	850

HIERRO to rodzina opraw produkowana w Fabryce Kanlux. Minimalistyczna i elegancka forma wpisuje się w najnowsze trendy architektonicznego dizajnu. Stylowe rozwiązanie znajduje szerokie zastosowanie w nowoczesnych biurach, sklepach, a także przestrzeniach typu loft jako oświetlenie podstawowe, uzupełniające lub akcentujące. Dużymi atutami opraw HIERRO są: zróżnicowanie dostępnych sposobów sterowania i montażu, niski współczynnik UGR, wysoka skuteczność świetlna, możliwość dopasowania pod konkretne projekty oświetleniowe i 5 lat gwarancji. Pozwala to na tworzenie energooszczędnych i nowoczesnych systemów oświetleniowych, zapewniających atrakcyjne efekty świetlne.

- Materiał obudowy: stal, tworzywo sztuczne
- Materiał klosza: tworzywo sztuczne



## HIERRO

### Oprawa liniowa LED



HR-LL-WW-W-NT



HR-LM-WW-W-NT



HR-LH-WW-W-NT



HR-LL-WW-B-NT



HR-LM-WW-B-NT



HR-LH-WW-B-NT



HR-LL-WN-W-NT



HR-LM-WN-W-NT



HR-LH-WN-W-NT



HR-LL-WN-B-NT



HR-LM-WN-B-NT



HR-LH-WN-B-NT



HR-LL-NW-W-NT



HR-LM-NW-W-NT



HR-LH-NW-W-NT



HR-LL-NW-B-NT

## HIERRO

---

### Oprawa liniowa LED



HR-LM-NW-B-NT



HR-LH-NW-B-NT

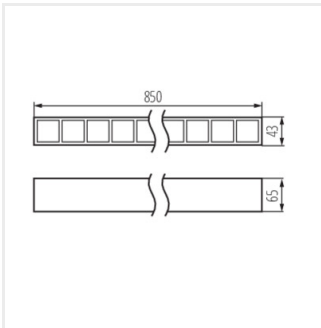

HR-LH-NT

