

















## MARIN

Stropné bodové svietidlo

IP  
44/20

 12 AC; 12 DC	 Gx5,3			<b>IP</b> 44/20		 Ø60-62
	 0,12	 0,75	 0,5m		 MR-16	
						

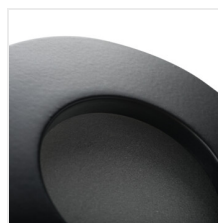

MARIN CT-S80-C



MARIN CT-S80-C	<b>04703</b>	max 10	chróm	chýbajúce
MARIN CT-S80-SN	<b>04704</b>	max 10	matný nikel	chýbajúce
MARIN CT-S80-AB	<b>04710</b>	max 10	matná mosadz	chýbajúce
MARIN CT-S80-W	<b>32500</b>	max 10	biela	chýbajúce
MARIN CT-S80-B	<b>32501</b>	max 10	čierna matná	chýbajúce

Kanlux MARIN je malé odolné stropné svietidlo, ktoré môžeme použiť v miestach s vysokou vlhkosťou. Môžeme ich ľahko umiestniť do kúpeľne nad zrkadlo, do kuchyne alebo do pracovne.

- Materiál korpusu: oceľ

## MARIN

Stropné bodové svietidlo



MARIN CT-S80-SN



MARIN CT-S80-AB



MARIN CT-S80-W



MARIN CT-S80-B

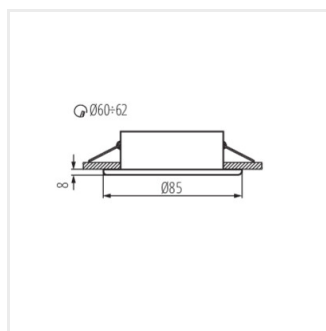

MARIN CT