















Snímač pohybu PIR

 [V] 220-240 AC	 [Hz] 50	 IP 20			 [m] max 10	 [lx] 3-2000
 [°C] -20÷40		 [mm <sup>2</sup> ] 1÷2,5				



ZONA JQ-37-W



ZONA JQ-37-W **00464** 1200 k zabudovaniu na strop H360/V120 15-7 PIR

Kanlux ZONA JQ je snímač pohybu s maximálnym detekčným dosahom 10 metrov. Môžeme nastaviť čas svietenia a úroveň intenzity svetla pri ktorej čidlo pracuje.

- maximálny dosah snímača je 10m
- maximálny horizontálny detekčný uhol snímača je 360 °
- maximálny vertikálny detekčný uhol snímača je 120 °
- možnosť nastavenia intervalu svietenia od 15s do 10 min
- možnosť nastavenia svetelnej intenzity, pri ktorej zariadenie pracuje
- Materiál: plast

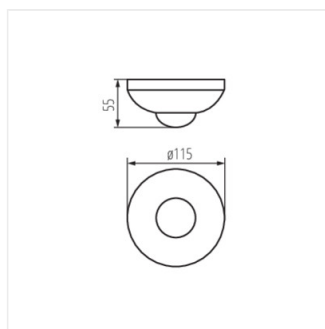

ZONA JQ-37

Snímač pohybu PIR

